



The Mercedes-Benz Vito.

Tourer.

Prices effective from June 2024.

Mercedes-Benz





RETURN TO START



Contents

> Model overview	3
> Trims	
Vito Tourer PRO	4
Vito Tourer SELECT	5
> Colours and Upholstery	6
> Equipment	7
> Engine and gearbox	14
> Fuel consumption	15
> Weights and payloads	16
> Dimensions	17
> List prices	19
> Finance options	20
> Mercedes me connectivity	21
> Approved Used	22
> Service24	23

Please note

This document provides information about the model range line-up and specifications of the Vito Tourer. It also contains key details about options, economy and performance of all variants. Details are correct at time of publication and are subject to revision. Any images used in this document may not reflect UK specification and are for illustrative purposes only. Images may show optional equipment which does not form part of UK standard specification.

Enhanced Safety.



RETURN TO START

The Vito is based on a sophisticated safety concept. Active driving assistance and safety systems offer useful functions to support the driver. A significantly expanded standard range of assistance systems is available.

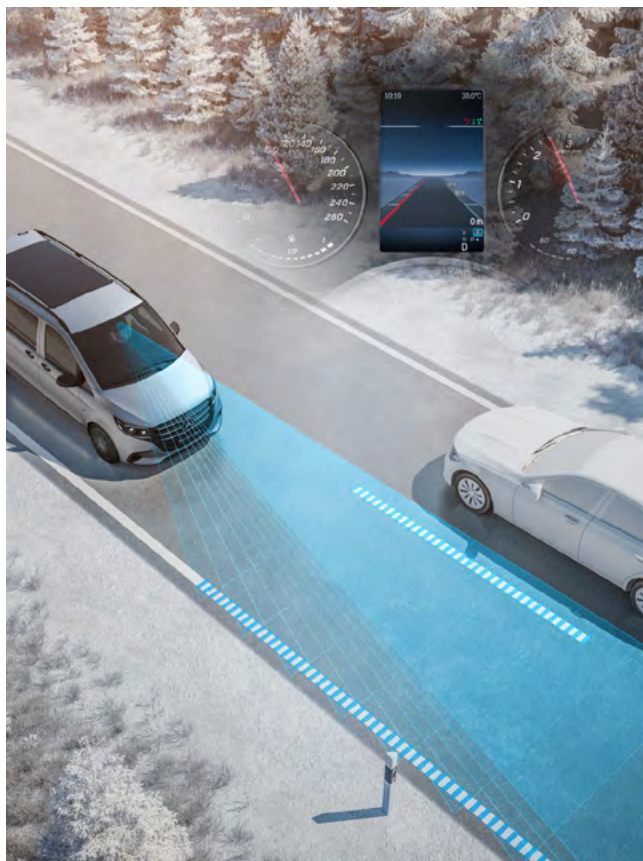

Active Lane Keeping Assist (JB4)

Protects against unintentional lane departure. If the system's camera detects a lane departure, a corrective steering intervention takes place to guide the vehicle back into the lane. If the driver fails to react and the vehicle crosses the lane markings, an additional haptic warning occurs (pulsed vibration via the steering wheel).



Blind Spot Assist (JA7)

Helps when changing lanes and reversing. If a vehicle is detected, a warning sign in a red triangle appears in the corresponding exterior mirror.



Intelligent Speed Assist (JS2)

Displays the current speed limit in the driver's direct field of vision in the instrument cluster.



ATTENTION ASSIST (JW8)

Can help to avoid momentary nodding off and therefore provides you with increased safety, in particular when driving at night and on long journeys. The system provides you with a visual and audible warning if it identifies typical signs of fatigue or attention lapses, and suggests taking a break.



Active Brake Assist (BA3)

With pedestrian and cyclist detection. The system helps to prevent rear-end collisions. Active Brake Assist can help you to prevent accidents (with vehicles driving in front, with crossing pedestrians or cyclists) or to minimise their consequences.

The Vito Tourer PRO.

Standard features include:

Interior

- TEMPMATIC air conditioning
- Comfort driver's seat
- Double co-driver's seat
- 3-seater bench 1st row with folding outer seat
- 3-seater bench 2nd row
- Adjustable steering wheel, reach and rake
- Multifunction steering wheel
- Leather steering wheel
- Locking glovebox
- Modern instrument cluster with 5.5" TFT colour display
- 12V outlets for rear seat row, right and left

Exterior

- 17" steel wheels with wheel covers
- Summer tyres
- Exterior mirrors heated and electrically adjustable
- Sliding door, left and right side

Rear Passenger Area

- Plastic flooring, TPO, in passenger compartment
- Interior panelling higher execution
- Tailgate
- Grab handles in rear
- Panelling under roof

Safety and Driver Assistance Systems

- Driver and Co-driver airbag
- Active Brake ASSIST
- ATTENTION ASSIST
- Intelligent Speed Assist and Active Lane Keeping Assist
- Headlight assistant
- Reversing camera
- Blind spot assist
- Cruise control
- Anti-Theft protection package
- Double locks
- Emergency call system

Technology

- MBUX multimedia system with 10.25" Touchscreen
- 2-way loudspeakers, front and rear
- Smartphone integration package



RETURN TO START



Basic recommended list price (ex.VAT) for the Vito 114 Tourer L2 PRO

£45,165

➤ [Arrange a test drive at your nearest Dealership](#)

The Mercedes-Benz Vito Tourer 4

The Vito Tourer SELECT.

Upgrade from PRO to SELECT to get all of the additional equipment listed below:

Interior

- Chrome interior appointments package
- Grab handles for driver's and co-driver's doors
- Carpet in interior at front and rear
- Lighting for footwell, front
- Interior and ambient lighting
- 3-seater comfort bench 1st and 2nd row with folding outer seat
- Illuminated vanity mirrors for sun visors
- Armrests for passenger compartment seats

Exterior

- 17" Alloy wheels (5 twin-spoke design)
- Chromed radiator grille
- LED tail lamps, brake lamps and indicators
- MULTIBEAM LED with Highbeam Assist PLUS
- Electrically folding wing mirrors
- Exit lamps
- Metallic paint
- Body coloured bumpers

Safety and Driver Assistance Systems

- Parking package with reversing camera
- Mirror package



RETURN TO START



Basic recommended list price (ex.VAT) for the Vito 116 Tourer L2 SELECT

£52,345

[▶ Arrange a test drive at your nearest Dealership](#)

Colours and upholstery.



RETURN TO START

Solid paints



Arctic White
(Standard for PRO)



Jupiter Red



Navy Blue

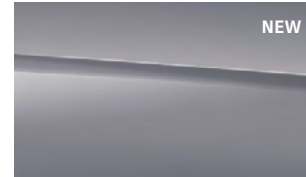

Alpine Grey



Vintage Blue

Metallic paints

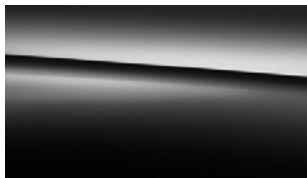

Obsidian Black



Hightech Silver

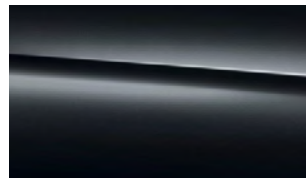

Graphite Grey



Sodalite Blue

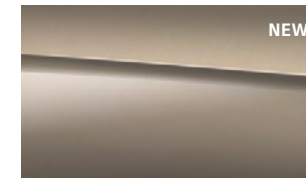

Kalahari Gold



Hyacinth Red

Interior upholstery



Black Caluma seat upholstery
(Standard)

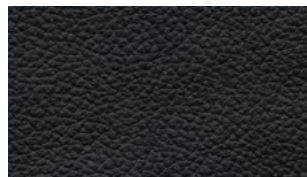

Black leatherette seat upholstery
(Optional on the Vito PRO
and SELECT)

Equipment.



RETURN TO START

Key: ● Standard ○ Optional — Not available

Equipment	Description	Option code	Tourer PRO	Tourer SELECT	Basic Price exc. VAT	Basic Price inc. VAT
Upgrade packages						
Mirrors	Mirror package The Vito Mirror package uses automatically dimming mirrors and electrically folding outside mirrors to increase the driving comfort and driving safety.	FP2	○	●	£450.00	£540.00
Security	Anti-theft protection package STANDARD ON ALL MODELS Thatcham category 1 approved. Includes cab interior and load-space monitoring with double locks, battery back-up siren and tow-away protection as standard on all Vito models.	FY1	●	●	—	—
Trim and Upholstery	Chrome interior appointment package The Chrome interior package further enhances the look of the driver's and front passenger's area with its trim elements on the dashboard and in the front doors.	FP4	○	●	£175.00	£210.00
Driver Assistance	Driving Assistance package Includes new features: Route based speed adjustment (JM3); Extended automatic start-up on motorways (JM2) and Active speed limit assist (JM4)	JS3	○	○	£1,200.00	£1,440.00
Heating and Ventilation	Winter package Includes the following: - Heated seat for driver (H16) - Heated windscreen washer system (F48)	F2W	○	○	£760.00	£912.00

Changes to individual option availability and combinations may occur depending on vehicle specification choices and the continuing evolution and adaptation of our product range. These changes may not be immediately reflected in this document as they occur, but will be introduced at the next revision opportunity.

Equipment (standard and optional overview).

● Standard ○ Optional — Not available



RETURN TO START

Equipment	Description	Option code	Tourer PRO	Tourer SELECT	Basic Price exc. VAT	Basic Price inc. VAT
Exterior Features						
Bodywork	Chromed radiator grille Only available in conjunction with painted bumpers (CM2).	FK2	○	●	£175.00	£210.00
	Roof rails Maximum load of 150kg, when supported by three carrier bars.	D12	○	○	£500.00	£600.00
Fuel Tanks	70L fuel tank	KB5	●	●	—	—
	Large AdBlue tank (24L)	KP7	●	●	—	—
Paint	Colour-coded front and rear bumpers	CM2	○	●	£435.00	£522.00
	Metallic paint Price of paint is dependent on colour.	n/a	○	○	Varies by colour	
Tyres	All-season tyres Compared to summer tyres, all-season tyres excel with better traction in wintry road conditions.	RM0	○	○	£225.00	£270.00
	Mud and slush tyres The M+S tyres can improve traction and lateral support in wintry road conditions, improving driving safety on snow, ice and mud.	RM1	○	○	£210.00	£252.00
	Summer tyres	RM7	●	●	—	—
Wheels	17" steel wheels Wheel: 6.5 J x 17 ET 51 Tyres: 225/55 R17	RS7	●	—	—	—
	17" Full wheel cover	RD8	●	—	—	—
	17" Alloy wheels (5 twin-spoke design) Wheel: 7 J x 17 ET 51 Tyres: 225/55 R17 or 235/55 R17	R1N	○	●	£830.00	£996.00
	Light alloy wheels 8 J x 19	RL3	○	○	£2,010.00	£2,412.00
	17" Alloy wheels (20 spoke design) Painted in vanadium silver Wheel: 7 J x 17 ET 51 Tyres: 225/55 R 17	RK8	○	○	£830.00	£996.00
Interior Features						
Flooring	Velour floor mats The black velour floor mats visually enhance the cockpit and underscore the elegant, sporty wellness ambience in the vehicle.	VL2	○	○	£65.00	£78.00
Gearbox	9G-TRONIC PLUS (automatic)	G43	●	●	—	—
Grab Handles	Grab handles for driver's and co-driver's doors	T75	○	●	£65.00	£78.00

Changes to individual option availability and combinations may occur depending on vehicle specification choices and the continuing evolution and adaptation of our product range. These changes may not be immediately reflected in this document as they occur, but will be introduced at the next revision opportunity.

Equipment (standard and optional overview).

● Standard ○ Optional — Not available



RETURN TO START

Equipment	Description	Option code	Tourer PRO	Tourer SELECT	Basic Price exc. VAT	Basic Price inc. VAT
Interior Features (cont.)						
Heating and ventilation	Diesel-powered auxiliary air heater The hot-water auxiliary heater indulges driver and passengers right from the start of the journey with cosy warmth.	H12	○	○	£1,285.00	£1,542.00
	Heated driver's seat	H16	○	○	£260.00	£312.00
	Heated dual co-driver's seat	H15	○	○	£260.00	£312.00
	TEMPMATIC air conditioning Cools and dehumidifies the air. Features a particulate filter to remove particles of dust and pollen from the outside air.	HH9	●	●	—	—
	THERMOTRONIC automatic climate control Automatically controls temperature, airflow and air distribution in 2 separate climate zones. If outside temperatures are very low, the residual heat mode (REST) can make use of the heat stored in the engine's coolant circuit for up to 30mins after the engine has been switched off.	HH4	○	○	£800.00	£960.00
Seating	Comfort driver's seat Single armrest on the side facing the front passenger; fore/aft adjustment (225mm in total, with 4.5mm intervals); stepless adjustment of the seat backrest angle; stepless seat height adjustment; comfort head restraint adjustable for angle and height.	SB1	●	●	—	—
	Comfort co-driver's seat Comfort driver and co-driver seat with inboard armrests and 4-way adjustable headrests. This deletes the double co-driver seat and therefore limits the cab area to two occupants. Only in conjunction with 3.0t weight variant (X3G).	SB2	○	○	£0.00	£0.00
	Double co-driver's seat Bench seat with 2x three-point seat belts, height-adjustable head restraints, and a fixed 17° backrest.	S23	●	●	—	—
	3-seater bench as luxury bunk, 2nd rear seat row	US3	○	○	£570.00	£684.00
	3-seater comfort bench 1st row with folding outer seat	US4	○	●	£600.00	£720.00
	3-seater comfort bench 2nd row with folding outer seat	US5	○	●	£770.00	£924.00
	Driver's seat plus with level sitting surface	SF3	○	—	£0.00	£0.00
	Co-driver's seat plus with level sitting surface	SF4	○	—	£0.00	£0.00
	Lumbar support for driver's seat Electropneumatically operated dual-cushion 4-way lumbar support, adjusted using a switch on the outer side of the seat cushion. The position of the air cushions can also be adjusted for height.	SE5	●	●	—	—
	Lumbar support for co-driver's seat Not compatible with Double co-driver seat (S23).	SE4	○	○	£0.00	£0.00

Changes to individual option availability and combinations may occur depending on vehicle specification choices and the continuing evolution and adaptation of our product range. These changes may not be immediately reflected in this document as they occur, but will be introduced at the next revision opportunity.

Equipment (standard and optional overview).

● Standard ○ Optional — Not available



RETURN TO START

Equipment	Description	Option code	Tourer PRO	Tourer SELECT	Basic Price exc. VAT	Basic Price inc. VAT
Interior Features (cont.)						
Steering Wheel	Height and rake adjustable steering wheel Manually adjustable by 4.8° in tilt and 60mm in/out.	CL1	●	●	—	—
	Multifunctional steering wheel	C6L	●	●	—	—
	Leather steering wheel	CL3	●	●	—	—
Storage	Centre console with stowage compartment	FF1	○	○	£125.00	£150.00
	Locking glove compartment Lock operated using the manual emergency key which is integrated within the electronic ignition key.	F66	●	●	—	—
Trim and upholstery	Black Caluma seat upholstery	VF4	●	●	—	—
	Black leatherette seat upholstery The black man-made leather lends the interior a comfortable aspect and impresses with its low-maintenance surface.	VU9	○	○	£225.00	£270.00
Technology, Software & Electrics						
Audio Entertainment and Navigation	MBUX multimedia system	E7M	●	●	—	—
	2-way loudspeakers, front and rear	EL9	●	●	—	—
	Smartphone Integration package Required for Android Auto and Apple CarPlay.	E4S	●	●	—	—
	Wireless charging system for mobile devices	EI0	○	○	£105.00	£126.00
	Navigation	E1E	○	○	£890.00	£1,068.00
Keys	Two additional master keys	FZ9	○	○	£175.00	£210.00
Driver's Assistance & Safety						
Airbags	Driver airbag	—	●	●	—	—
	Co-driver airbag	SA6	●	●	—	—
	Driver thorax-pelvis sidebag	SH1	●	●	—	—
	Co-driver thorax-pelvis sidebag	SH2	●	●	—	—
	Windowbags for driver and co-driver Windowbags on the driver's and front-passenger's side can contribute to reducing the risk of head and facial injuries in the event of severe accidents involving major side-on impact.	SH9	●	●	—	—

Changes to individual option availability and combinations may occur depending on vehicle specification choices and the continuing evolution and adaptation of our product range. These changes may not be immediately reflected in this document as they occur, but will be introduced at the next revision opportunity.

Equipment (standard and optional overview).

● Standard ○ Optional — Not available



RETURN TO START

Equipment	Description	Option code	Tourer PRO	Tourer SELECT	Basic Price exc. VAT	Basic Price inc. VAT
Driver's Assistance & Safety (cont.)						
Driver's Assistance	Active Brake ASSIST Can detect the danger of a collision with the vehicle ahead, stationary traffic and pedestrians by reacting with a visual and audible warning – braking automatically if there is no driver reaction.	BA3	●	●	–	–
	Active Distance ASSIST DISTRONIC Automatically maintains the distance to vehicles in front. The system accelerates the vehicle by itself and brakes it with a maximum of half the vehicle's braking power in order to maintain a safe distance.	ET4	○	○	£1,130.00	£1,356.00
	ATTENTION ASSIST With the help of numerous parameters, the ATTENTION ASSIST function can detect typical signs of drowsiness and warn the driver.	JW8	●	●	–	–
	Comfort overhead control panel LED interior lighting including cab downlighting and co-/driver reading lamps; also includes a convenient spectacles compartment.	LC4	●	●	–	–
	Cruise Control Includes speed limiter function. Operated via a lever ergonomically positioned on the left of the steering column.	MS1	●	●	–	–
	Headlight assistant A windscreen sensor continuously monitors light conditions and automatically switches the dipped beams on/off upon reaching pre-defined limits.	LA2	●	●	–	–
	Active Lane Keeping Assist Warns the driver if lane markings are crossed unintentionally.	JB4	●	●	–	–
	Blind Spot Assist	JA7	●	●	–	–
	Intelligent Speed Assist	JS2	●	●	–	–
	Traffic Sign Assist	JA9	○	○	–	–
	Speed Limiter – 130mph (210km/h)	MK8	●	●	–	–
	Tyre pressure monitoring, wireless Monitors air pressure in all 4 wheels. Slight pressure variances generate a visual warning. Sudden, extreme pressure losses trigger an additional acoustic warning.	RY2	●	●	–	–
Parking	Reversing camera	FR8	●	–	–	–
	Parking package with reversing camera	JB7	○	●	£1,285.00	£1,542.00
	Reversing warning device The reverse warning alarm warns pedestrians and other road users audibly of the reversing vehicle and thereby enhances their safety.	JW0	○	○	£115.00	£138.00

Changes to individual option availability and combinations may occur depending on vehicle specification choices and the continuing evolution and adaptation of our product range. These changes may not be immediately reflected in this document as they occur, but will be introduced at the next revision opportunity.

Equipment (standard and optional overview).

● Standard ○ Optional — Not available



RETURN TO START

Equipment	Description	Option code	Tourer PRO	Tourer SELECT	Basic Price exc. VAT	Basic Price inc. VAT
Driver's Assistance & Safety (cont.)						
Safety Equipment	Accident recovery and breakdown management The vehicle will automatically call the Mercedes-Benz Customer Assistance Center at a press of a button to provide the driver with professional help in the event of an emergency.	EY6	●	●	—	—
	PRE-SAFE The PRE-SAFE® anticipatory occupant protection system can detect critical driving situations at an early stage and initiate preventive protection measures.	JP1	○	○	£450.00	£540.00
	First aid kit	Y10	○	○	£65.00	£78.00
	Warning triangle	Y44	○	○	£0.00	£0.00
	Jack	Y36	○	○	£75.00	£90.00
	Spare Wheel with Jack	RR6	○	○	£215.00	£258.00
Lighting						
Lighting	MULTIBEAM LED with Highbeam Assist PLUS	L45	○	●	£2,305.00	£2,766.00
	LED tail lamps, brake lamps and indicators	LG4	○	●	£0.00	£0.00
	Blinker lights on rear of roof The additional turn signal lamps on rear of roof improve the visibility of the vehicle, thus enhancing perceptual safety.	L84	○	○	£195.00	£234.00
	Interior and ambient lighting	LP2	○	●	£310.00	£372.00
Loading & Towing						
Towing	Gross vehicle weight 3.2T	XA5	●	●	—	—
	Gross vehicle weight 3.1T	XA8	○	○	£0.00	£0.00
Ground clearance	Increased ground clearance The increased ground clearance by 10mm is particularly beneficial on rough roads or when driving over ramps.	C14	○	○	£240.00	£288.00
Towing Equipment	Trailer coupling, rigid coupling head	Q22	○	○	£490.00	£588.00
	Trailer coupling ball headed removable	Q50	○	○	£915.00	£1,098.00
	Electrical components for trailer socket	E57	●	●	—	—
	Trailer load 2,500kg* The uprated towing load of 2,500kg makes it possible to tow up to 500kg additional load. * Requires 9G-TRONIC	QA4	○	○	£145.00	£174.00

Changes to individual option availability and combinations may occur depending on vehicle specification choices and the continuing evolution and adaptation of our product range. These changes may not be immediately reflected in this document as they occur, but will be introduced at the next revision opportunity.

Equipment (standard and optional overview).

● Standard ○ Optional — Not available



RETURN TO START

Equipment	Description	Option code	Tourer PRO	Tourer SELECT	Basic Price exc. VAT	Basic Price inc. VAT
Mirrors & Windows						
Mirrors	Electrically folding wing mirrors Fold-in/out function is operated via controls in the driver door.	F64	○	●	£330.00	£396.00
	Heated, electrically adjustable wing mirrors Mirror heating reduces condensation in cold weather and prevents icing-up of the mirrors. The exterior mirrors are heated automatically upon vehicle start when the outside temperature is low or when the rear defrost function is activated.	F68	●	●	—	—
	Illuminated vanity mirrors for sun visors	FS5	○	●	£170.00	£204.00
Windows	Black-tinted windows in rear 90% window tint offers attractive thermal and privacy protection. Applies to all windows after the B-pillar.	W70	○	○	£520.00	£624.00
	Heat-insulating glass Windscreen (laminated glass), side windows and rear window (single-pane safety glass) are tinted green, reducing the sunlight's heating effect on the interior.	H20	●	●	—	—
	Heated windscreen washer system	F48	○	○	£245.00	£294.00
	Sliding window in left sliding door	W18	○	○	£325.00	£390.00
	Sliding window in right sliding door	W19	○	○	£325.00	£390.00

Changes to individual option availability and combinations may occur depending on vehicle specification choices and the continuing evolution and adaptation of our product range. These changes may not be immediately reflected in this document as they occur, but will be introduced at the next revision opportunity.

Engine and gearbox.



RETURN TO START

Engine specifications	114CDI	116CDI
Fuel	Diesel	
Engine designation	OM654	
Mixture preparation/ injection method	Common-rail direct injection, 1,600bar max. injection pressure	
Cylinder arrangement	4, in-line	
Cubic capacity	1,950cc	
EU exhaust emission standard	Euro 6	
Output, max.	136hp	163hp
	100kW	120kW
	136PS	163PS
	@ 3,800rpm	
Torque, max.	330Nm @ 1,200-2,400rpm	380Nm @ 1,400-2,400rpm
Fuel tank capacity	70L	
AdBlue® capacity	24L	24L
Diesel Particulate Filter [DPF]	●	●
9G-TRONIC automatic gearbox	●	●
Driven Axle	Rear	
Alternator	14V / 200A with Alternator Management (battery charged during braking and overrun)	
Battery - DGS	12V / 95Ah (AGM)	

● Standard ○ Optional — Not available

Fuel consumption, performance and CO₂ emissions.



RETURN TO START

Model	WLTP CO ₂ emissions (g/km)					WLTP Fuel Consumption (l/100km/MPG)				
	Combined	Low-speed	Medium-speed	High-speed	Extra high-speed	Combined	Low-speed	Medium-speed	High-speed	Extra high-speed
Tourer - PRO										
114 Tourer PRO L2	184	230	186	158	189	7.0/ 40.4	8.8/ 32.1	7.1/ 39.8	6.0/ 47.1	7.2/ 39.2
114 Tourer PRO L3	186	233	187	160	190	7.1/ 39.8	8.9/ 31.7	7.1/ 39.8	6.1/ 46.3	7.2/ 39.2
116 Tourer PRO L2	184	231	186	158	189	7.0/ 40.4	8.8/ 32.1	7.1/ 39.8	6.0/ 47.1	7.2/ 39.2
116 Tourer PRO L3	186	233	188	160	190	7.1/ 39.8	8.9/ 31.7	7.1/ 39.8	6.1/ 46.3	7.3/ 38.7
Tourer - SELECT										
116 Tourer SELECT L2	188	236	190	161	192	7.1/ 39.8	9.0/ 31.4	7.2/ 39.2	6.1/ 46.3	7.3/ 38.7

All figures are based on a standard specification. The choice of wheels and transmission may affect CO₂ emissions and corresponding Road Fund Licence. The indicated values were determined according to the prescribed measurement method - Worldwide Harmonised Light Vehicle Test Procedure (WLTP). Figures shown may include options which are not available in the UK. Figures shown are for comparability purposes; only compare with other vans tested to the same technical procedures. Figures may not reflect real life driving results, which will depend upon a number of factors including factory-fitted options, accessories fitted (post registration), variations in weather, driving styles and vehicle load. Further information about the test used to establish fuel consumption and CO₂ figures can be found at <https://www.mercedes-benz.co.uk/vans/en/WLTP>

Weights and payloads.



RETURN TO START

Model	Gross Vehicle Weight (kg)	Payload (kg)	Kerb weight, with driver (kg)*	Gross Train Weight (kg)
Tourer - PRO				
114 Tourer PRO L2	3,200	918	2,282	5,200
114 Tourer PRO L3	3,200	891	2,309	5,200
116 Tourer PRO L2	3,200	914	2,286	5,200
116 Tourer PRO L3	3,200	887	2,313	5,200
Tourer - SELECT				
116 Tourer SELECT L2	3,200	822	2,378	5,200

* Kerb weight includes 75kg driver

All figures are based on a standard specification. The choice of wheels and transmission may affect CO₂ emissions and corresponding Road Fund Licence. The indicated values were determined according to the prescribed measurement method – Worldwide Harmonised Light Vehicle Test Procedure (WLTP). Figures shown may include options which are not available in the UK. Figures shown are for comparability purposes; only compare with other vans tested to the same technical procedures. Figures may not reflect real life driving results, which will depend upon a number of factors including factory-fitted options, accessories fitted (post registration), variations in weather, driving styles and vehicle load. Further information about the test used to establish fuel consumption and CO₂ figures can be found at <https://www.mercedes-benz.co.uk/vans/en/WLTP>

Dimensions.



RETURN TO START

Vito Tourer L2

Wheelbase	Wheelbase length	3,200mm
	Turning circle	11.8m
	Track circle	11m
	Front track width	1,666mm
	Rear track width	1,646mm
Vehicle	Length	5,140mm
	Height (unladen)	1,912mm/ 1,909mm (SELECT)
	Width (inc. wing mirrors)	2,244mm
	Ground clearance	112mm
Load compartment	Length	699mm/ 724mm (SELECT)
	Max. width	1,665mm
	Width between wheel arches	1,205mm
	Height	1,220mm

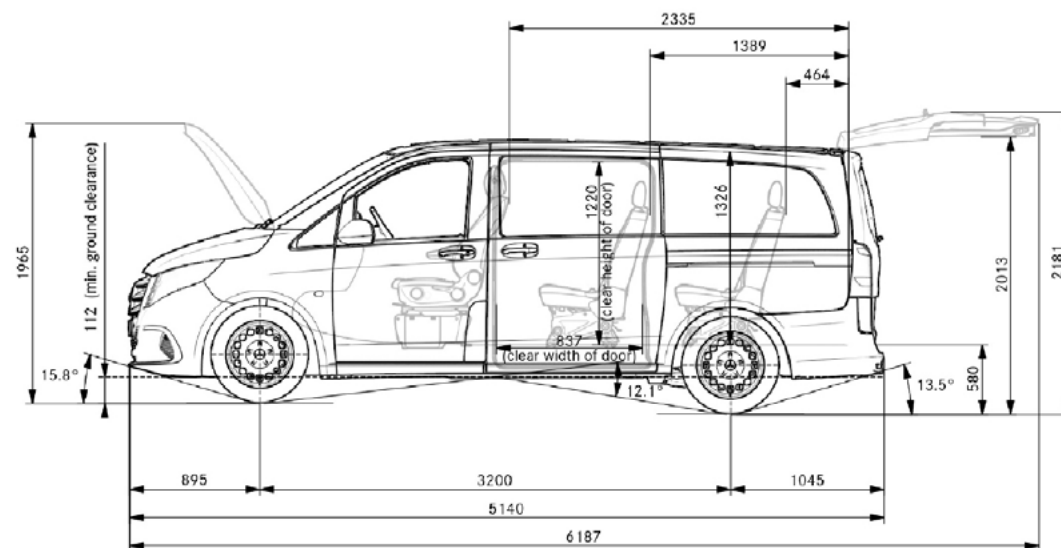
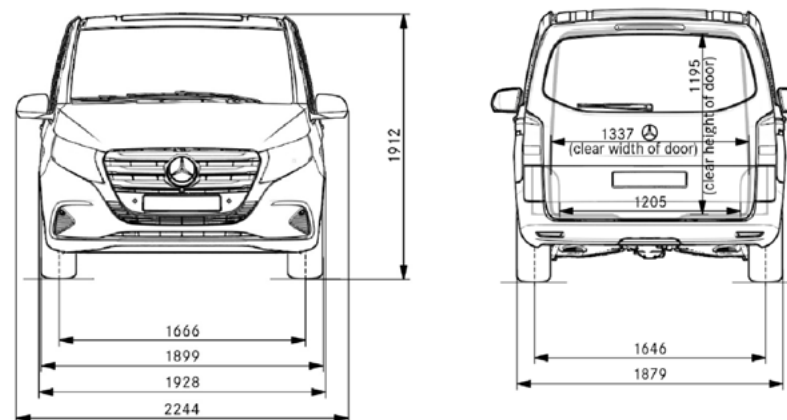

Dimensions.



RETURN TO START

Vito Tourer L3

Wheelbase	Wheelbase length	3,430mm
	Turning circle	12.5m
	Track circle	11m
	Front track width	1,666mm
	Rear track width	1,646mm
Vehicle	Length	5,370mm
	Height (unladen)	1,914mm
	Width (inc. wing mirrors)	2,244mm
	Ground clearance	112mm
Load compartment	Length	929mm
	Max. width	1,665mm
	Width between wheel arches	1,205mm
	Height	1,220mm

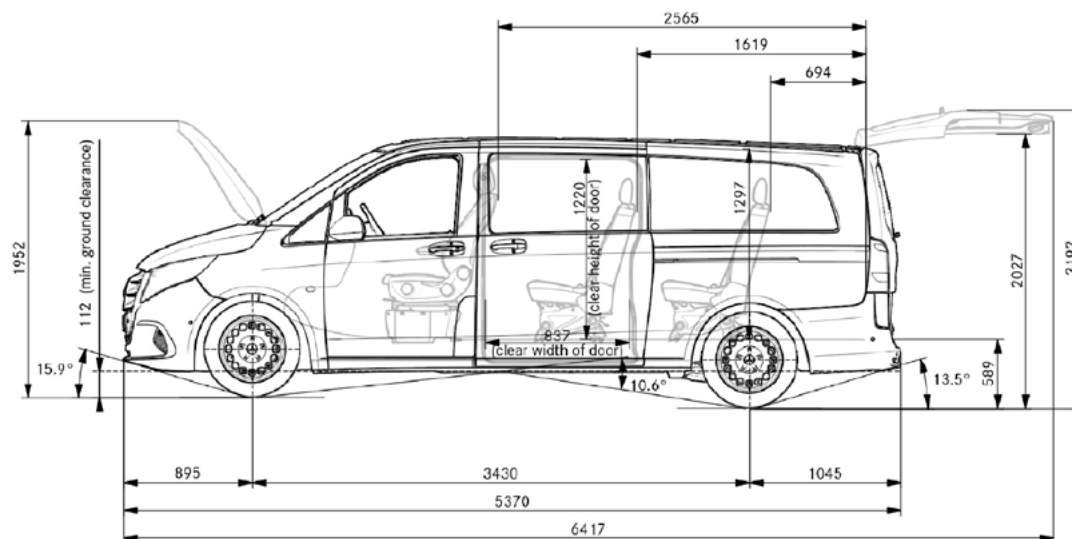
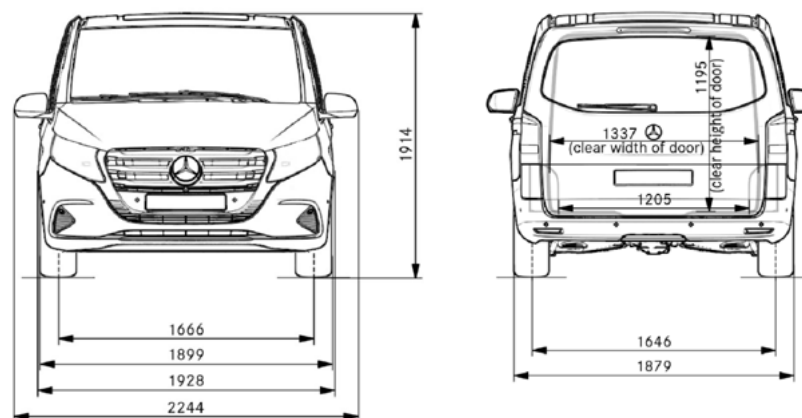

List prices.



RETURN TO START

Model	Transmission	Basic Recommended Retail Price (Ex. VAT)	Basic Recommended Retail Price (Inc. VAT)
Tourer – PRO			
114 Tourer L2 PRO	9G-TRONIC (auto)	£45,165	£54,198
114 Tourer L3 PRO	9G-TRONIC (auto)	£46,210	£55,452
116 Tourer L2 PRO	9G-TRONIC (auto)	£46,900	£56,280
116 Tourer L3 PRO	9G-TRONIC (auto)	£47,940	£57,528
Tourer – SELECT			
116 Tourer L2 SELECT	9G-TRONIC (auto)	£52,345	£62,814

This document is for guidance only and must be used in conjunction with a configuration tool prior to final specification decisions and vehicle quotations being prepared and accepted. List prices are quoted ex-factory unless otherwise stated. Delivery charges excluding VAT will be added to model prices quoted in this document. Prices based on standard finish paint choice. Mercedes-Benz Vans UK and authorised Dealers reserve the right to alter specification and vary prices without notice. The availability of options may depend on the chosen base vehicle and other optional equipment specified, and should be confirmed with your Mercedes-Benz Vans Dealer prior to order placement. VAT is calculated at the standard rate of 20%. Mercedes-Benz Vans UK Ltd, Tongwell, Milton Keynes MK15 8BA.



RETURN TO START

Mercedes-Benz Finance options.

Choose an agreement that suits you with Mercedes-Benz Finance.

At Mercedes-Benz Finance we understand what it takes to run a modern-day business. Because of this, we have a number of finance options ready to suit your business needs.

Agility (Personal Contract Plan)

Agility (Personal Contract Plan) is our most flexible method of financing. You drive the vehicle over a fixed term, with fixed monthly payments. And at the end of the agreement, you decide whether you want to:

- Buy another Mercedes-Benz.
- Purchase your van by paying the Optional Purchase payment (balloon) and Option to Purchase Fee.
- Return it to us.

As a business customer, your vehicle can also appear as an asset on your balance sheet.

[For more information about Agility.](#)

Hire Purchase

A straightforward route to ownership. This product allows you to spread the overall cost of your Mercedes-Benz over a fixed term.

As a business customer, your vehicle can also appear as an asset on your balance sheet.

[For more information on Hire Purchase.](#)

Operating Lease

A solution for those who want to drive one of our vehicles over a specific term, with fixed monthly rentals and without the commitment of ownership of the vehicle.

As a business customer, your vehicle can also appear as an asset on your balance sheet.

[For more information on Operating Lease.](#)

Contract Hire

A solution for those who want to drive one of our vans over a specific term, with fixed monthly rentals and without the need to commit to ownership of the vehicle. This includes the cost of your Vehicle Excise Duty (also known as Road Fund Licence) for the duration of your agreement.

As a business customer, your vehicle can also appear as an asset on your balance sheet.

[For more information on Contract Hire.](#)

Finance Lease

Finance Lease gives you the ability to enjoy driving a Mercedes-Benz Van for a fixed time without the option of ownership. With this option you lease your vehicle for a fixed period and for fixed monthly rentals.

As a limited company or PLC customer, your vehicle can also appear as an asset on your balance sheet.

[For more information on Finance Lease.](#)

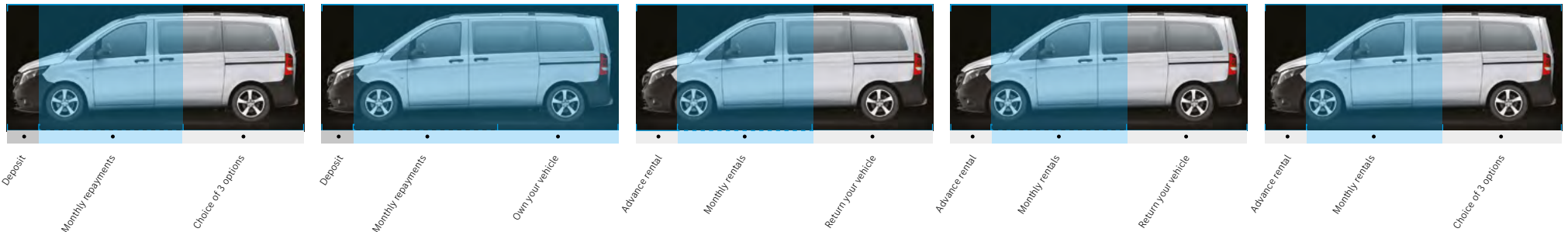

[For more information about our finance options](#)

Mercedes me connectivity.



RETURN TO START

Monitor your van's status, location and security via your smartphone.



ASSISTANCE & AFTERCARE		FREE
Telediagnosics & Maintenance Management	Receive a notification when wear is detected on diagnostic-capable parts such as brake pads and get advance notice of when a service is due allowing you to plan your workshop visit well in advance to minimise any impact on your business.	
Remote Vehicle Diagnostics	Your Dealer can assess your van's condition remotely allowing them to check if any other repairs are required ahead of a service.	
Accident Recovery & Breakdown Management	Once an emergency call has been resolved or if you request breakdown assistance, further support is offered to help recover your van or to tow it to a Mercedes-Benz Service outlet.	
Software updates	Over-the-air software updates are sent directly to your van's head unit. This means you'll always know your software is up to date and you'll save time by avoiding additional workshop visits.	
VEHICLE SUPERVISION		FREE FOR 3 YEARS
Vehicle Tracker	See your van's location on the map in your app, making it easy to call or message your driver and re-route them to fit in another delivery or pick-up if a quicker route is available. The tracker is factory fitted equipment so it can't be easily removed if stolen.	
Parked Vehicle Locator	If you're within 1 mile of your van's parked location, the app can generate the most convenient walking route – very handy if you're in unfamiliar surroundings and on a busy schedule.	
REMOTE ACCESS		FREE FOR 3 YEARS
Remote Retrieval of Vehicle Status	Use your app to check on fuel level, tyre pressure, mileage and trip information. Not only does this help you plan your day's journeys, it can save you admin time on tasks such as logging your mileage for expenses.	
Remote Door Locking & Unlocking	The app allows you to check if your van is locked. If you lock your keys in the van or need to give another driver access, you can do it via the app, from any distance away. For added peace of mind, you'll receive an email notification when your vehicle is unlocked.	

Mercedes-Benz Approved Used vans.

Get used to more...



More choice. More confidence. More quality – and more added extras.

As a Mercedes-Benz Approved Used customer, you'll have complete peace of mind as every van offers the same commitment to quality and workmanship as new and comes with:



Minimum 12-month warranty*
PLUS the option of monthly top-ups, up to 24 months*



Free MOT test failure cover**
covering you for £1,500

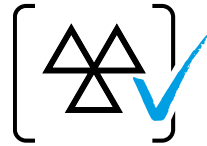

Minimum 3 months MOT



Free 24/7 breakdown cover
and roadside assistance^



Free 7-day driveaway
van insurance^^



Comprehensive
multi-point vehicle check

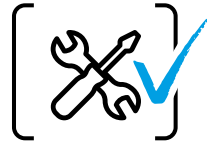

Discounted
service plans

▶ [View our Dealer Networks Approved Used van stock](#)

* Warranty eligible up to 200,000 miles on approved used Mercedes-Benz Vans with less than 150,000 miles at point of sale. Top ups are to a maximum of 24 months. For full T&Cs, please speak to your preferred sales representative. ** MOT cover redeemable per 12-months warranty. £1,500 claims limit. For more information, please speak to your preferred sales representative. ^ Free for 12 months initially and renewed at each service, if serviced by Mercedes-Benz according to service intervals for up to 30 years from when the vehicle was first registered. For a full list of exclusions and all product terms please visit mbvans.co.uk/mobilovan ^^ Available on single vehicle policies only and applicable on Vehicles up to 3.5t only. For full terms and conditions, please consult your local Dealer. Mercedes-Benz Van Insurance is a trading name of Mercedes-Benz Insurance Services UK Limited. Prices are correct at time of going to press 07/2023. All prices are subject to any fiscal or legislative changes.



Approved
Used



What is an Approved Used van?

- Is no older than 6 years old
- Has less than 150,000 miles on the clock
- Is eligible for one of our flexible finance plans

▶ [Find more information and our latest Approved Used offers](#)

Ready to go electric?

▶ [Find our latest Approved Used Electric offers](#)

The Mercedes-Benz Vito Tourer

22

Service24: Demand more

The most comprehensive Aftercare package – for businesses that demand more.

Our 120-strong Dealer network works around the clock to service and maintain your vans and keep your business moving. It all adds up to more value, more flexibility and more confidence that you'll only find at an authorised Mercedes-Benz Dealer.



› Flexible servicing and maintenance

Book your service online or by telephone, and as well as a standard 'drop and go' service with a courtesy van, you'll also get:

- Early bird, late night and weekend slots
- Mobile service
- Overnight service
- Collect & deliver service
- Express 1hr service
- Electric van service.

[Find out more about service and repairs](#)



› Flexible ways to pay and save

With fixed, transparent national pricing there are no surprises with our services and repairs – plus you can fix, spread and reduce your service and maintenance costs, and ease your cashflow at the same time, with a payment plan.

- Pay as You Go
- ServiceCare Maintenance
- ServiceCare Flex (specifically for fleets)
- ServiceCare Complete.

[Find out more about service options](#)

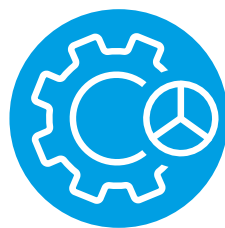

› 3-year unlimited mileage warranty

Available on every new van, all service and maintenance – and any work required – is covered by your 3-year unlimited mileage warranty, and is only undertaken by Mercedes-Benz trained technicians using Mercedes-Benz GenuineParts.

[Find out more about warranties](#)



› Free breakdown cover & roadside assistance*

Every van comes with free Europe-wide breakdown cover – MobiloVan. And with 3 years' cover on new vehicles for driver mishaps, no one goes further to keep your business moving.

- Trained technicians using only Mercedes-Benz GenuineParts
- Forward travel of load and crew is covered
- Driver mishap cover for the first 3 years, including out of charge cover or empty fuel tanks.

[Find out more about MobiloVan](#)

*For a full list of exclusions and all product terms please visit www.mercedes-benz.co.uk/vans/en/Owners/MobiloVan

