



# The GLE SUV

Effective from September 2022 Production.

Mercedes-Benz







Book a test drive



Buy your GLE SUV



Find a Retailer



Some of the model features, optional extras and colours shown may not be available, or may only be available in a different specification, or at a different price.

Design	Technology	Plug-In Hybrid	Model lines	Upholstery	Model prices	Mercedes-AMG	Mercedes-AMG prices	Mercedes-AMG upholstery	Personalisation	Standard equipment	Genuine accessories	Technical data	Additional information
--------	------------	----------------	-------------	------------	--------------	--------------	---------------------	-------------------------	-----------------	--------------------	---------------------	----------------	------------------------



[Book a test drive](#)[Buy your GLE SUV](#)[Find a Retailer](#)

Some of the model features, optional extras and colours shown may not be available, or may only be available in a different specification, or at a different price.

<a href="#">Design</a>	<a href="#">Technology</a>	<a href="#">Plug-In Hybrid</a>	<a href="#">Model lines</a>	<a href="#">Upholstery</a>	<a href="#">Model prices</a>	<a href="#">Mercedes-AMG</a>	<a href="#">Mercedes-AMG prices</a>	<a href="#">Mercedes-AMG upholstery</a>	<a href="#">Personalisation</a>	<a href="#">Standard equipment</a>	<a href="#">Genuine accessories</a>	<a href="#">Technical data</a>	<a href="#">Additional information</a>
------------------------	----------------------------	--------------------------------	-----------------------------	----------------------------	------------------------------	------------------------------	-------------------------------------	---	---------------------------------	------------------------------------	-------------------------------------	--------------------------------	--





Book a test drive



Buy your GLE SUV



Find a Retailer



Some of the model features, optional extras and colours shown may not be available, or may only be available in a different specification, or at a different price.

Design	Technology	Plug-In Hybrid	Model lines	Upholstery	Model prices	Mercedes-AMG	Mercedes-AMG prices	Mercedes-AMG upholstery	Personalisation	Standard equipment	Genuine accessories	Technical data	Additional information
--------	------------	----------------	-------------	------------	--------------	--------------	---------------------	-------------------------	-----------------	--------------------	---------------------	----------------	------------------------



[Book a test drive](#)[Buy your GLE SUV](#)[Find a Retailer](#)

Some of the model features, optional extras and colours shown may not be available, or may only be available in a different specification, or at a different price.

<a href="#">Design</a>	<a href="#">Technology</a>	<a href="#">Plug-In Hybrid</a>	<a href="#">Model lines</a>	<a href="#">Upholstery</a>	<a href="#">Model prices</a>	<a href="#">Mercedes-AMG</a>	<a href="#">Mercedes-AMG prices</a>	<a href="#">Mercedes-AMG upholstery</a>	<a href="#">Personalisation</a>	<a href="#">Standard equipment</a>	<a href="#">Genuine accessories</a>	<a href="#">Technical data</a>	<a href="#">Additional information</a>
------------------------	----------------------------	--------------------------------	-----------------------------	----------------------------	------------------------------	------------------------------	-------------------------------------	---	---------------------------------	------------------------------------	-------------------------------------	--------------------------------	--





Book a test drive



Buy your GLE SUV



Find a Retailer



Some of the model features, optional extras and colours shown may not be available, or may only be available in a different specification, or at a different price.

Design	Technology	Plug-In Hybrid	Model lines	Upholstery	Model prices	Mercedes-AMG	Mercedes-AMG prices	Mercedes-AMG upholstery	Personalisation	Standard equipment	Genuine accessories	Technical data	Additional information
--------	------------	----------------	-------------	------------	--------------	--------------	---------------------	-------------------------	-----------------	--------------------	---------------------	----------------	------------------------





Book a test drive



Buy your GLE SUV



Find a Retailer



GLE



# Technology

Some of the model features, optional extras and colours shown may not be available, or may only be available in a different specification, or at a different price.

Design	Technology	Plug-In Hybrid	Model lines	Upholstery	Model prices	Mercedes-AMG	Mercedes-AMG prices	Mercedes-AMG upholstery	Personalisation	Standard equipment	Genuine accessories	Technical data	Additional information
--------	------------	----------------	-------------	------------	--------------	--------------	---------------------	-------------------------	-----------------	--------------------	---------------------	----------------	------------------------





Book a test drive



Buy your GLE SUV



Find a Retailer

# Mercedes-Benz User Experience (MBUX)

Transforming the in-car user experience, thanks to MBUX: Controlled via voice or touch input, the innovative infotainment system can over time even predict personal habits thanks to artificial intelligence.



Using the touchpad you can control the display of the multimedia system



Multi-gesture touchpad control

## Voice control

- Activated by the keywords “Hey Mercedes”, the new intelligent voice control LINGUATRONIC<sup>1</sup> lets you control many of the infotainment functions, including destination input, phone calls or music selection
- MBUX is able to understand different accents and will adjust to you over time
- MBUX even understands indirect commands. Feeling chilly? Just say “I feel cold” and MBUX will adjust the temperature for you

## Personalisation

- Turn the new GLE into your very own Mercedes-Benz by personalising driving modes, radio stations and much more
- Your personal settings can be saved in up to seven different profiles, making your driving experience the best one possible
- Thanks to artificial intelligence, MBUX is able to learn and adapt over time. It will be able to predict your personal habits, such as navigation for frequently-driven routes, or the radio station you like to listen to on your way home from work

## Touch inputs

- Beside voice control you can operate MBUX via touchscreen, the touchpad on the centre console, as well as touch control buttons on the steering wheel
- The touchpad recognises your handwriting should you wish to enter addresses or phone numbers silently

## Maintenance and service

- Wondering when the next service is due? Or how much further you can drive until you need to stop at a petrol station? Just ask your MBUX – it will tell you the answer

<sup>1</sup>LINGUATRONIC off-board functions are currently only available for three years

Design	Technology	Plug-In Hybrid	Model lines	Upholstery	Model prices	Mercedes-AMG	Mercedes-AMG prices	Mercedes-AMG upholstery	Personalisation	Standard equipment	Genuine accessories	Technical data	Additional information
--------	------------	----------------	-------------	------------	--------------	--------------	---------------------	-------------------------	-----------------	--------------------	---------------------	----------------	------------------------



# Mercedes me connect

Stay connected any time, anywhere.

# Mercedes me

Mercedes me is a range of innovative online services designed to enhance your Mercedes-Benz experience. Accessible via mobile, tablet or PC, Mercedes me lets you enjoy the highest standards of care and support, in a way that integrates seamlessly with your busy lifestyle.

### Safety and Service – Mercedes me connect helps to keep you and your car safe

Check your car's oil level, tyre pressure and fuel from your phone so you'll be ready for every journey.

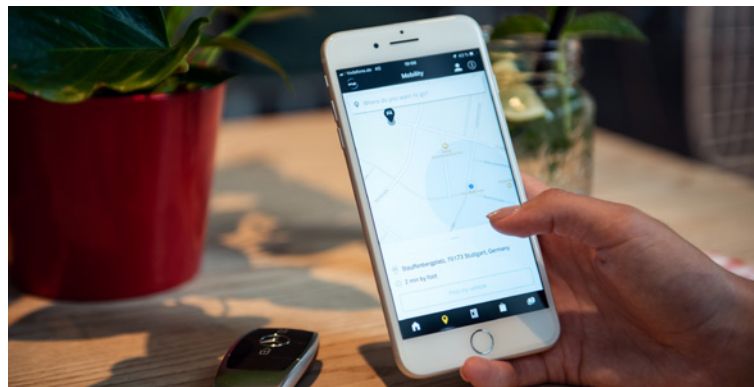

### Infotainment – Online and Entertainment services from Mercedes me connect

Love music? Get a 3-month free subscription to Tidal when you connect your car.

### Live Traffic Information, Parked Vehicle Locator and much more with Mercedes me connect

Forgot where you've parked? Parked Vehicle Locator<sup>1</sup> will show you exactly where your car is as long as you're in a 1-mile radius of where you parked. Real-time traffic data and dynamic route with shorter journey times.

For more information speak to your local Retailer or visit the Mercedes me connect store at [shop.mercedes-benz.com/en-gb/connect](http://shop.mercedes-benz.com/en-gb/connect)

### Comfort – connect to your car anytime, anywhere

Forgot to lock your car? With Remote Car Lock<sup>2</sup> you will receive a notification on your smartphone to let you know. With one tap, you can lock and unlock your vehicle so you never have to worry.

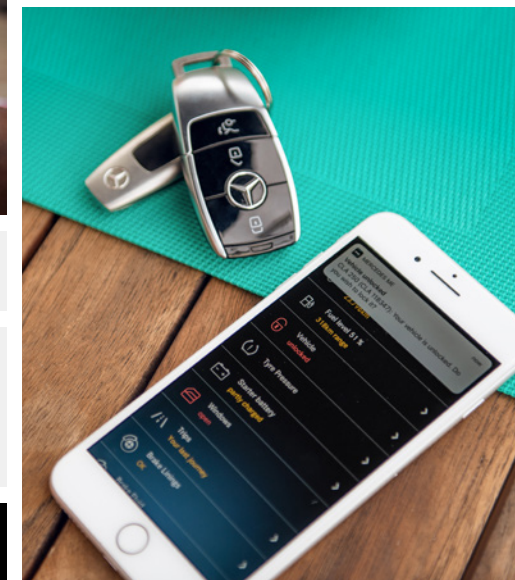

<sup>1</sup>Available on all models with the Vehicle Monitoring package. This option may vary between standard and additional cost dependent on the model

<sup>2</sup>Part of the Vehicle Status package. This option may vary between standard and additional cost dependent on the model

Images shown are for illustration purposes only



# Driving Assistance package

The Driving Assistance package<sup>1</sup> contains a range of highly intelligent features to help you stay safe on the road.

**Driving Assistance package<sup>1</sup>** (code 23P) – designed as a package, including items as listed.

**Standard on AMG Line Premium Plus and Mercedes-AMG GLE 53 4MATIC+ Premium Plus and Mercedes-AMG GLE 63 S 4MATIC+**

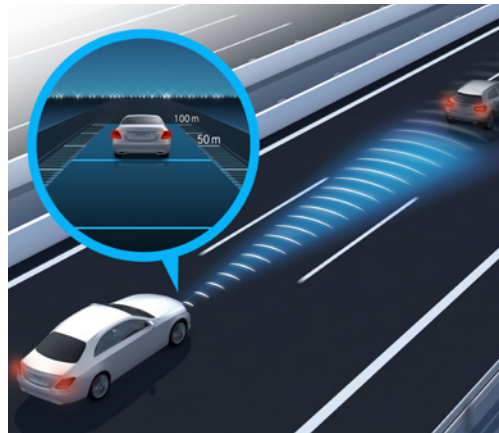
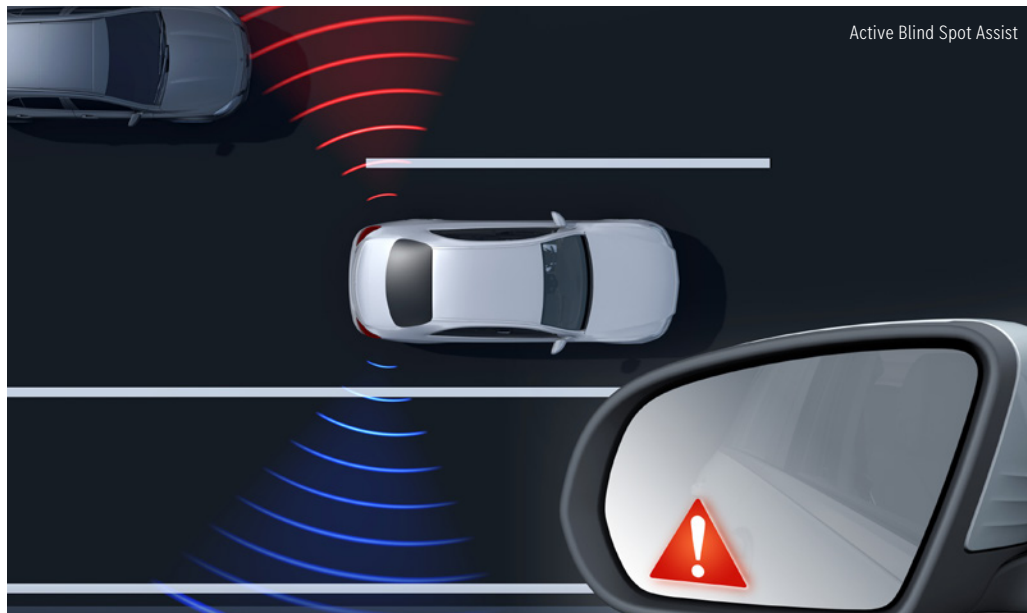

**Active Blind Spot Assist** can warn the driver of vehicles in the blind spot during a lane change and can help to avoid a collision by means of one-sided braking intervention

**Active Braking Assist with cross-traffic function** can help to avoid accidents with vehicles ahead, crossing traffic and also pedestrians, and/or mitigate their consequences

**Active Distance Assist DISTRONIC** helps maintain the desired distance from the vehicle in front

**Active Emergency Stop Assist:** immediate emergency braking if evasion is impossible

**Active Lane Keeping Assist**

**Active Speed Limit Assist** ensures detected speed limits are automatically adopted as the set speed for Active Distance Assist DISTRONIC

**Active Steering Assist:** targeted steering intervention to prevent unintentional drifting out of lane

**Active Stop-and-Go Assist<sup>4</sup>**

**Evasive Steering Assist** can support the driver in making evasive manoeuvres if, in a dangerous situation, he/she moves to avoid any pedestrian detected by the system

**Pedestrian warning function near pedestrian crossings**

**PRE-SAFE® PLUS:** when a rear-end collision threatens, it can initiate preventive measures, including warning following traffic and locking the brakes on standstill

**Route-based speed adjustment:** adaption of speed before curves, roundabouts and junctions

**Traffic Sign Assist**

<sup>1</sup>Our driver assistance and safety systems are aids and do not relieve you of your responsibility as the driver. Please take note of the information in the Owner's Manual and the system limits which are described therein

Design	Technology	Plug-In Hybrid	Model lines	Upholstery	Model prices	Mercedes-AMG	Mercedes-AMG prices	Mercedes-AMG upholstery	Personalisation	Standard equipment	Genuine accessories	Technical data	Additional information
--------	------------	----------------	-------------	------------	--------------	--------------	---------------------	-------------------------	-----------------	--------------------	---------------------	----------------	------------------------





Book a test drive



Buy your GLE SUV



Find a Retailer

GLE

# Plug-In Hybrid



Design	Technology	Plug-In Hybrid	Model lines	Upholstery	Model prices	Mercedes-AMG	Mercedes-AMG prices	Mercedes-AMG upholstery	Personalisation	Standard equipment	Genuine accessories	Technical data	Additional information
--------	------------	----------------	-------------	------------	--------------	--------------	---------------------	-------------------------	-----------------	--------------------	---------------------	----------------	------------------------



# Plug-in Hybrid Electric Vehicle (PHEV) Benefits of driving a plug-in hybrid.

Our plug-in hybrids feature either a petrol or diesel powertrain, combined with a High Voltage battery and electric motor. Enjoy hybrid mode for maximum efficiency, or all-electric mode for local emission-free driving.

## Lower running costs

Did you know that electric cars could cost up to a third less than a diesel or petrol car to run, as well as being cheaper to maintain? We've partnered with Go Ultra Low, a joint Government and car industry campaign, to give you unbiased advice on making the switch to an electric car. Use Go Ultra Low's cost saving calculator to see how much you can save.<sup>1</sup>

[> Discover more](#)

## Lower road fund license

Plug-in hybrid vehicles have lower emissions – this means you pay less for road tax.

## Cleaner vehicle discount

Plug-in hybrid models qualify for the 100% cleaner vehicle discount within the London Congestion Charge zone.

## Business benefits

With 100% first-year capital allowances<sup>2</sup> and lower Company Car tax, electric cars offer significant benefits to businesses and employees.

[> Click here for more information](#)

<sup>1</sup>Please note that by clicking below you will be directed to the Go Ultra website <sup>2</sup>100% first-year capital allowances only apply to vehicles less than 50 g CO<sub>2</sub>/km



[Book a test drive](#)[Buy your GLE SUV](#)[Find a Retailer](#)

# Plug-in Hybrid Electric Vehicle (PHEV) The GLE 350 de.

Plug-in hybrid vehicles enjoy the same functionality of full Hybrid technology, with the added benefit that they can be charged from an external electricity source.

## GLE 350 de 4MATIC

Diesel – 1,950 cc, 4-cylinder, 194 hp/143 kW

Electric motor – 136 hp/100kW

### Available as:

AMG Line, AMG Line Premium, AMG Line Premium Plus

OTR from **£70,220<sup>1</sup>**



### Standard equipment

Charging cable – Mode 3 cable (8 metres, straight), for wallbox and public charging stations

Charging socket

Charging system – AC charging system rated at 7.4 kW (Three Phase)

Pre-entry climate control

Radar-based recuperation

Remote and Charging Services Plus

### Technical details

Equivalent All-Electric Range (EAER) <sup>2</sup>	55–58 miles
AC charging time, 10–100% <sup>3</sup>	
At a wallbox (3.7 kW AC Single Phase)	6 hrs 45 mins
At a charging station (7.4 kW AC Three Phase)	3 hr 30 mins
DC charging time, 10–80% (60 kW)	20 mins
Range power consumption, combined <sup>24</sup>	29.3–27.7 kWh/100 km
Battery type (usable)	lithium-ion (31.0 kWh)
Capacity on-board charger	3.7 kW (AC Single Phase)/7.4 kW (AC Three Phase)/60 kW (DC)

<sup>1</sup>The recommended on-the-road price includes the Road Fund Licence applicable to the standard model plus delivery charge (£730.00 incl. VAT), new vehicle registration fee (£55.00), fuel (£50.00 incl. VAT), and number plates (£25.00 incl. VAT). VAT is calculated at the standard rate of 20%. Some of the model features, optional extras and colours shown may not be available, or may only be available in a different specification, or at a different price. <sup>2</sup>The indicated values were determined according to the prescribed measurement method - Worldwide Harmonised Light Vehicle Test Procedure (WLTP). Figures shown may include options which are not available in the UK. For Plug-in Hybrid Electric Vehicle (PHEV) figures determined with the battery fully charged, using a combination of both battery power and fuel. These models require mains electricity for charging. <sup>3</sup>Specified voltage and current values refer to network infrastructure and can be limited by the vehicle. Times are from 10-100% charge using a wallbox (single phase or three-phase) or standard socket (single-phase). <sup>4</sup>The certified electrical consumption is generally determined at maximum AC charging capacity using a Mode 3 cable. It is therefore recommended that vehicles with a HV battery preferably be charged at a wallbox or an AC charging station with a Mode 3 cable in order to achieve shorter charging times and improved charging efficiency.

Design	Technology	Plug-In Hybrid	Model lines	Upholstery	Model prices	Mercedes-AMG	Mercedes-AMG prices	Mercedes-AMG upholstery	Personalisation	Standard equipment	Genuine accessories	Technical data	Additional information
--------	------------	----------------	-------------	------------	--------------	--------------	---------------------	-------------------------	-----------------	--------------------	---------------------	----------------	------------------------

# Mercedes me Charge One registration, one contract, one billing.

Mercedes *me*

Mercedes me Charge provides access to a multitude of public charging stations located in shopping centers, hotels or at motorway services. A smartphone app as well as the vehicle's navigation system show the precise location, current availability and price at the selected charging station.

### Tens of thousands charging stations in the UK

Growing network of charging providers includes bp pulse the largest charging network in the UK. Customers also get six months free bp pulse+ membership which reduces the electricity price when charging.



### Access to fast-charging stations

Enables customers to get access to charging stations of different providers with:

- Mercedes me app
- RFID card
- Mercedes-EQ Vehicle Head unit

### Green charging

All charging using Mercedes me Charge, will be retrospectively 'greened' by Mercedes-Benz. Please click [here](#) for more info.

### Transparent and easy billing

One invoice charging processes for payment.

### Easy access

Charging stations are displayed in Mercedes me app and in MBUX multimedia system.

### No fees

Mercedes me Charge is standard for one year with discounted IONITY rapid-charging for one year.







# Mercedes me Charge Tariffs



For more transparency and predictability, enjoy numerous features tailored to your charging habits with the new Mercedes me Charge fixed-priced tariffs S, M and L. Owners of a new Plug-in Hybrid model will be entitled to the Mercedes me Charge tariff M free of charge for the duration of 12 months.

## Tariff L

Recommended for 'frequent drivers'

Choose our tariff L to benefit from the best fixed prices for public charging, including discounted rapid-charging at IONITY charging stations as well as all Mercedes me Charge features. This tariff is recommended for frequent and long-distance drivers.

Consisting of:

- All Mercedes me Charge features
- Fixed prices per kWh (AC: £0.30/kWh; DC: £0.39/kWh)<sup>1</sup>
- IONITY rapid-charging stations discounted (£0.26/kWh)

**£16.20/month**

## Tariff M

Recommended for 'regular drivers'

Should you wish to downgrade your tariff package after 12 months but still want to benefit from fixed prices, discounted rapid-charging at IONITY charging stations and complete transparency, choose tariff M. This tariff is recommended for regular drivers.

Consisting of:

- All Mercedes me Charge features
- Fixed prices per kWh (AC: £0.35/kWh; DC: £0.45/kWh)<sup>1</sup>
- IONITY rapid-charging stations discounted (£0.45/kWh)

**Free of charge for the duration of 12 months.**

**Thereafter:**

**£4.90/month**

## Tariff S

Recommended for 'casual drivers'

Should you wish to downgrade your tariff package after 12 months, there is the option to go for tariff S, which still offers you all the Mercedes me Charge features based on flexible prices per kWh. This tariff is recommended for casual drivers.

Consisting of:

- All Mercedes me Charge features
- Flexible prices per kWh

**£0/month**



<sup>1</sup>Tariff rate excludes the BP Pulse charging network

Design	Technology	Plug-In Hybrid	Model lines	Upholstery	Model prices	Mercedes-AMG	Mercedes-AMG prices	Mercedes-AMG upholstery	Personalisation	Standard equipment	Genuine accessories	Technical data	Additional information
--------	------------	----------------	-------------	------------	--------------	--------------	---------------------	-------------------------	-----------------	--------------------	---------------------	----------------	------------------------

# Home charging with bp pulse Simple, convenient, fast charging.



Mercedes-Benz plug-in vehicle customers with off-street parking can benefit from the convenience and speed of charging at home by installing a home charger. Charge your vehicle with the home charger up to 3x faster than using a standard domestic socket.

## Home charging with bp pulse: £999\* incl. VAT and standard installation

### Key benefits of bp pulse:

bp pulse is one of the only full-service charging solution providers in the UK – producing and installing tens of thousands of their own smart-enabled and reliable Homecharge units across the country.

A comprehensive 3 year warranty.

The standard installation package includes up to 15m of external cabling.

It comes with a bundled offer of 3 month free subscription to the public network and 250 free miles of charge.

The bp pulse home unit is designed from the ground up to be user friendly, future proofed and feature packed with an exciting roadmap of over the air updates ahead.

The bp pulse public network consists of over 9,000 charging bays across the UK. Average costs are between £0.30–£0.55 per kW across fast, rapid and ultra-rapid charge points with the best rates on a subscription basis.

Choice of tethered or un-tethered units

### OZEV Grant:

You may be entitled to claim for an OZEV grant towards the cost of your home charger.<sup>1</sup> To find out whether you are entitled please contact your local Retailer.

### Questions?

Please contact your local Retailer to submit an enquiry to your chosen charging partner on your behalf. To find your local Retailer, please click the button at the top right hand corner.

### Warning!

If you are planning to charge your Mercedes-Benz plug-in electric vehicle using a 3-pin domestic plug socket you must get a qualified electrician to inspect and sign off the socket to confirm it is safe and suitable to charge your vehicle. Do not use an electric vehicle 3-pin charge cable with an extension cord.



\*Price excludes £350 OZEV EVHS Grant. Price correct at time of publication, subject to change  
<sup>1</sup>The home charger £350 Grant (including VAT) is only available to customers who meet the criteria of the Office for Zero Emission Vehicles (OZEV). For full details and eligibility criteria for the OZEV EVHS Grant, see <https://www.gov.uk/government/publications/electric-vehicle-homecharge-scheme-guidance-for-customers-version-21>.

Design	Technology	Plug-In Hybrid	Model lines	Upholstery	Model prices	Mercedes-AMG	Mercedes-AMG prices	Mercedes-AMG upholstery	Personalisation	Standard equipment	Genuine accessories	Technical data	Additional information
--------	------------	----------------	-------------	------------	--------------	--------------	---------------------	-------------------------	-----------------	--------------------	---------------------	----------------	------------------------



# Home charging with Pod Point Simple, convenient, fast charging.



Mercedes-Benz plug-in vehicle customers with off-street parking can benefit from the convenience and speed of charging at home by installing a home charger. Charge your vehicle with the home charger up to 3x faster than using a standard domestic socket.

## Home charging with Pod Point: £875\* incl. VAT and standard installation

### Key benefits of Pod Point:

Pod Point is one of the leading provider of EV charging in the UK with over 120,000 home chargepoints installed.

A comprehensive 3 year 'swap out' warranty is included.

Auto Power Balancing lets you adjust your charge so that your electrical supply doesn't get overloaded when your home is using a lot of energy.

Built-in earthing protection removes the needs for expensive earth rods.

The Pod Point public network consists of over 6,200 charging bays across the UK with over 80% of the charge points free to use.

The standard installation package includes up to 15m of external cabling.

Choice of tethered or un-tethered units.

### OZEV Grant:

You may be entitled to claim for an OZEV grant towards the cost of your home charger.<sup>1</sup> To find out whether you are entitled please contact your local Retailer.

### Questions?

Please contact your local Retailer to submit an enquiry to your chosen charging partner on your behalf. To find your local Retailer, please click the button at the top right hand corner.

### Warning!

If you are planning to charge your Mercedes-Benz plug-in electric vehicle using a 3-pin domestic plug socket you must get a qualified electrician to inspect and sign off the socket to confirm it is safe and suitable to charge your vehicle. Do not use an electric vehicle 3-pin charge cable with an extension cord.



\*Price excludes £350 OZEV EVHS Grant. Price correct at time of publication, subject to change

<sup>1</sup>The home charger £350 Grant (including VAT) is only available to customers who meet the criteria of the Office for Zero Emission Vehicles (OZEV). For full details and eligibility criteria for the OZEV EVHS Grant, see <https://www.gov.uk/government/publications/electric-vehicle-homecharge-scheme-guidance-for-customers-version-21>.



Book a test drive



Buy your GLE SUV



Find a Retailer

# GLE Model lines overview



**AMG Line »**



**AMG Line Premium »**



**AMG Line Premium Plus »**

Design	Technology	Plug-In Hybrid	Model lines	Upholstery	Model prices	Mercedes-AMG	Mercedes-AMG prices	Mercedes-AMG upholstery	Personalisation	Standard equipment	Genuine accessories	Technical data	Additional information
--------	------------	----------------	-------------	------------	--------------	--------------	---------------------	-------------------------	-----------------	--------------------	---------------------	----------------	------------------------



# AMG Line Standard equipment highlights



Option shown: MANUFAKTUR hyacinth red metallic (code 996)



Option shown: MANUFAKTUR hyacinth red metallic (code 996)

### Engine, Transmission and Suspension

DYNAMIC SELECT with choice of driving modes: 'Eco', 'Comfort', 'Sport' and 'Individual'

### Exterior

20" AMG alloy wheels – 5-twin-spoke design, painted tremolite grey with high-sheen finish (code RZV)

Adaptive Highbeam Assist

Aluminium-look illuminated running boards with rubber studs

AMG bodystyling – front apron, rear apron and side skirts

Heat-insulating dark-tinted glass

LED High Performance headlamps

Mild hybrid with 48-volt on-board electrical system (300 d and 450 4MATIC only)

Summer tyres



OTR from **£67,410<sup>1</sup>**

<sup>1</sup>The recommended on-the-road price includes the Road Fund Licence applicable to the standard model plus delivery charge (£730.00 incl. VAT), new vehicle registration fee (£55.00), fuel (£50.00 incl. VAT), and number plates (£25.00 incl. VAT). VAT is calculated at the standard rate of 20%. Some of the model features, optional extras and colours shown may not be available, or may only be available in a different specification, or at a different price

Design	Technology	Plug-In Hybrid	Model lines	Upholstery	Model prices	Mercedes-AMG	Mercedes-AMG prices	Mercedes-AMG upholstery	Personalisation	Standard equipment	Genuine accessories	Technical data	Additional information
--------	------------	----------------	-------------	------------	--------------	--------------	---------------------	-------------------------	-----------------	--------------------	---------------------	----------------	------------------------



### Interior

Ambient lighting, staged – 64 colours

AMG Line floor mats

DAB digital radio tuner

Dashboard lining in ARTICO man-made leather

Four-way lumbar support

Mirror package – electrically folding mirrors and automatically-dimming driver's exterior mirror and rear-view mirror with image projection logo

Multifunction sports steering wheel in nappa leather

Seats – heated front seats

### Communications, Safety and Assistance Systems

Active Brake Assist<sup>1</sup>

Blind Spot Assist

MBUX multimedia system with DAB digital radio tuner

Parking package – incl. Active Parking Assist and reversing camera

Smartphone integration<sup>2</sup>

Touchpad

Traffic Sign Assist

Widescreen (12.3-inch) cockpit display

### Trim and Upholstery

Anthracite open-pore oak wood trim

Nappa leather – black

<sup>1</sup>Our driver assistance and safety systems are aids and do not relieve you of your responsibility as the driver. Please take note of the information in the Owner's Manual and the system limits which are described therein <sup>2</sup>Compatible mobile phone required



# AMG Line Premium Standard equipment highlights



In addition to/replacement of AMG Line:

**Exterior**

21" AMG alloy wheels – multi-spoke design, painted black with a high-shine finish (code RWB)

Summer tyres



OTR from **£70,910<sup>1</sup>**  
Upgrade price from AMG Line **£3,500**

<sup>1</sup>The recommended on-the-road price includes the Road Fund Licence applicable to the standard model plus delivery charge (£730.00 incl. VAT), new vehicle registration fee (£55.00), fuel (£50.00 incl. VAT), and number plates (£25.00 incl. VAT). VAT is calculated at the standard rate of 20%. Some of the model features, optional extras and colours shown may not be available, or may only be available in a different specification, or at a different price

Design	Technology	Plug-In Hybrid	Model lines	Upholstery	Model prices	Mercedes-AMG	Mercedes-AMG prices	Mercedes-AMG upholstery	Personalisation	Standard equipment	Genuine accessories	Technical data	Additional information
--------	------------	----------------	-------------	------------	--------------	--------------	---------------------	-------------------------	-----------------	--------------------	---------------------	----------------	------------------------



Parking package with 360° camera



THERMOTRONIC four zone climate control

**Interior**

Parking package with 360° camera

THERMOTRONIC four zone climate control

**Trim and Upholstery**

Anthracite open-pore oak wood trim

Nappa leather – black

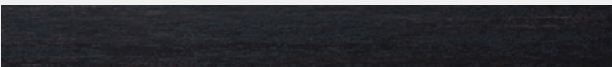



# AMG Line Premium Plus Standard equipment highlights



In addition to/replacement of AMG Line Premium:

### Engine, Transmission and Suspension

AIRMATIC air suspension

### Exterior

22" AMG alloy wheels – 5-twin-spoke design, painted black with a high-sheen finish (code RXT)

KEYLESS-GO Comfort package

Mirror package including projection of Mercedes-Benz logo

Panoramic glass sunroof

Summer tyres



OTR from **£75,210<sup>1</sup>**  
Upgrade price from AMG Line Premium **£4,300**

<sup>1</sup>The recommended on-the-road price includes the Road Fund Licence applicable to the standard model plus delivery charge (£730.00 incl. VAT), new vehicle registration fee (£55.00), fuel (£50.00 incl. VAT), and number plates (£25.00 incl. VAT). VAT is calculated at the standard rate of 20%. Some of the model features, optional extras and colours shown may not be available, or may only be available in a different specification, or at a different price

Design	Technology	Plug-In Hybrid	Model lines	Upholstery	Model prices	Mercedes-AMG	Mercedes-AMG prices	Mercedes-AMG upholstery	Personalisation	Standard equipment	Genuine accessories	Technical data	Additional information
--------	------------	----------------	-------------	------------	--------------	--------------	---------------------	-------------------------	-----------------	--------------------	---------------------	----------------	------------------------

**Interior**

Multifunction sports steering wheel in nappa leather

**Communications, Safety and Assistance Systems**

Driving Assistance package<sup>1</sup>

**Trim and Upholstery**

Anthracite open-pore oak wood trim

Nappa leather - black

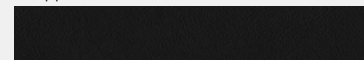
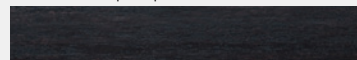

<sup>1</sup>Our driver assistance and safety systems are aids and do not relieve you of your responsibility as the driver. Please take note of the information in the Owner's Manual and the system limits which are described therein



[Book a test drive](#)[Buy your GLE SUV](#)[Find a Retailer](#)

# Upholstery

- Standard
- No-cost option



**801A nappa leather<sup>1</sup> - black**



**885A nappa leather<sup>1</sup> - two-tone white/black**



<sup>1</sup>100% of seat upholstery is pure leather

<a href="#">Design</a>	<a href="#">Technology</a>	<a href="#">Plug-In Hybrid</a>	<a href="#">Model lines</a>	<a href="#">Upholstery</a>	<a href="#">Model prices</a>	<a href="#">Mercedes-AMG</a>	<a href="#">Mercedes-AMG prices</a>	<a href="#">Mercedes-AMG upholstery</a>	<a href="#">Personalisation</a>	<a href="#">Standard equipment</a>	<a href="#">Genuine accessories</a>	<a href="#">Technical data</a>	<a href="#">Additional information</a>
------------------------	----------------------------	--------------------------------	-----------------------------	----------------------------	------------------------------	------------------------------	-------------------------------------	---	---------------------------------	------------------------------------	-------------------------------------	--------------------------------	--

[Book a test drive](#)[Buy your GLE SUV](#)[Find a Retailer](#)

# Model prices

Model line	Engine	Transmission	Seats	CO <sub>2</sub> WLTP <sup>1,*</sup>	Basic RRP excl. VAT (£)	Total RRP incl. VAT (£)	Road Fund Licence (£) <sup>2</sup> WLTP	Rec. OTR price (£) <sup>3</sup> WLTP	P11D value (£)	BiK tax rate 2022/23 (%) <sup>2</sup>
<b>AMG Line</b>										
GLE 300 d 4MATIC	Diesel – 1,993 cc, 4-cylinder, 272 hp/200 kW Mild hybrid drive – 22 hp/15 kW	9G-TRONIC 9-speed automatic	5	179	54,679.17	65,615.00	935.00	<b>67,410.00</b>	66,420.00	37
GLE 350 de 4MATIC	Diesel – 1,950 cc, 4-cylinder, 194 hp/143 kW Electric motor – 136 hp/100 kW	9G-TRONIC 9-speed automatic	5	20	57,800.00	69,360.00	0.00	<b>70,220.00</b>	70,165.00	8
GLE 400 d 4MATIC	Diesel – 2,925 cc, 6-cylinder, 330 hp/243 kW	9G-TRONIC 9-speed automatic	7	206	57,141.67	68,570.00	1,420.00	<b>70,850.00</b>	69,375.00	37
GLE 450 4MATIC	Petrol – 2,999 cc, 6-cylinder, 367 hp/270 kW Mild hybrid drive – 22 hp/16 kW	9G-TRONIC 9-speed automatic	7	223	57,320.83	68,785.00	1,410.00	<b>71,055.00</b>	69,590.00	37
<b>AMG Line Premium</b>										
GLE 300 d 4MATIC	Diesel – 1,993 cc, 4-cylinder, 272 hp/200 kW Mild hybrid drive – 22 hp/15 kW	9G-TRONIC 9-speed automatic	5	185	57,595.83	69,115.00	935.00	<b>70,910.00</b>	69,920.00	37
GLE 350 de 4MATIC	Diesel – 1,950 cc, 4-cylinder, 194 hp/143 kW Electric motor – 136 hp/100 kW	9G-TRONIC 9-speed automatic	5	23	60,716.67	72,860.00	0.00	<b>73,720.00</b>	73,665.00	8
GLE 400 d 4MATIC	Diesel – 2,925 cc, 6-cylinder, 330 hp/243 kW	9G-TRONIC 9-speed automatic	7	219	60,058.33	72,070.00	1,420.00	<b>74,350.00</b>	72,875.00	37
GLE 450 4MATIC	Petrol – 2,999 cc, 6-cylinder, 367 hp/270 kW Mild hybrid drive – 22 hp/16 kW	9G-TRONIC 9-speed automatic	7	230	60,237.50	72,285.00	2,005.00	<b>75,150.00</b>	73,090.00	37

<sup>1</sup>The indicated values were determined according to the prescribed measurement method - Worldwide Harmonised Light Vehicle Test Procedure (WLTP). Figures shown may include options which are not available in the UK. <sup>2</sup>Figures shown are for comparability purposes; only compare with other cars tested to the same technical procedures. Figures may not reflect real life driving results, which will depend upon a number of factors including factory-fitted options, accessories fitted (post registration), variations in weather, driving styles and vehicle load. Further information about the test used to establish fuel consumption and CO<sub>2</sub> figures can be found at <http://www.mercedes-benz.co.uk/WLTP> <sup>3</sup>GLE 400 d engines are RDE (Real Driving Emissions) Step 2 Certified (Euro 6d). This results in a lower VED and BiK rate as these engines will not be subject to the diesel surcharge. A different first year rate of Vehicle Excise Duty (Road Fund Licence) applies for new cars. Please refer to page 54 for the relevant rate for the second and subsequent years <sup>4</sup>The recommended on-the-road price includes the Road Fund Licence applicable to the standard model plus delivery charge (£730.00 incl. VAT), new vehicle registration fee (£55.00), fuel (£50.00 incl. VAT), and number plates (£25.00 incl. VAT). VAT is calculated at the standard rate of 20%. Some of the model features, optional extras and colours shown may not be available, or may only be available in a different specification, or at a different price

Design	Technology	Plug-In Hybrid	Model lines	Upholstery	Model prices	Mercedes-AMG	Mercedes-AMG prices	Mercedes-AMG upholstery	Personalisation	Standard equipment	Genuine accessories	Technical data	Additional information
--------	------------	----------------	-------------	------------	--------------	--------------	---------------------	-------------------------	-----------------	--------------------	---------------------	----------------	------------------------



[Book a test drive](#)[Buy your GLE SUV](#)[Find a Retailer](#)

# Model prices

Model line	Engine	Transmission	Seats	CO <sub>2</sub> WLTP <sup>1,*</sup>	Basic RRP excl. VAT (£)	Total RRP incl. VAT (£)	Road Fund Licence (£) <sup>2</sup> WLTP	Rec. OTR price (£) <sup>3</sup> WLTP	P11D value (£)	BiK tax rate 2022/23 (%) <sup>2</sup>
<b>AMG Line Premium Plus</b>										
GLE 300 d 4MATIC	Diesel – 1,993 cc, 4-cylinder, 272 hp/200 kW Mild hybrid drive – 22 hp/15 kW	9G-TRONIC 9-speed automatic	5	186	61,179.17	73,415.00	935.00	<b>75,210.00</b>	74,220.00	37
GLE 350 de 4MATIC	Diesel – 1,950 cc, 4-cylinder, 194 hp/143 kW Electric motor – 136 hp/100 kW	9G-TRONIC 9-speed automatic	5	23	64,300.00	77,160.00	0.00	<b>78,020.00</b>	77,965.00	8
GLE 400 d 4MATIC	Diesel – 2,925 cc, 6-cylinder, 330 hp/243 kW	9G-TRONIC 9-speed automatic	7	220	63,641.67	76,370.00	1,420.00	<b>78,650.00</b>	77,175.00	37
GLE 450 4MATIC	Petrol – 2,999 cc, 6-cylinder, 367 hp/270 kW Mild hybrid drive – 22 hp/16 kW	9G-TRONIC 9-speed automatic	7	231	63,820.83	76,585.00	2,005.00	<b>79,450.00</b>	77,390.00	37

<sup>1</sup>The indicated values were determined according to the prescribed measurement method - Worldwide Harmonised Light Vehicle Test Procedure (WLTP). Figures shown may include options which are not available in the UK. <sup>2</sup>Figures shown are for comparability purposes; only compare with other cars tested to the same technical procedures. Figures may not reflect real life driving results, which will depend upon a number of factors including factory-fitted options, accessories fitted (post registration), variations in weather, driving styles and vehicle load. Further information about the test used to establish fuel consumption and CO<sub>2</sub> figures can be found at <http://www.mercedes-benz.co.uk/WLTP> <sup>3</sup>GLE 400 d engines are RDE (Real Driving Emissions) Step 2 Certified (Euro 6d). This results in a lower VED and BiK rate as these engines will not be subject to the diesel surcharge. A different first year rate of Vehicle Excise Duty (Road Fund Licence) applies for new cars. Please refer to page 54 for the relevant rate for the second and subsequent years <sup>4</sup>The recommended on-the-road price includes the Road Fund Licence applicable to the standard model plus delivery charge (£730.00 incl. VAT), new vehicle registration fee (£55.00), fuel (£50.00 incl. VAT), and number plates (£25.00 incl. VAT). VAT is calculated at the standard rate of 20%. Some of the model features, optional extras and colours shown may not be available, or may only be available in a different specification, or at a different price



Book a test drive



Buy your GLE SUV



Find a Retailer



AMG



GLE

# Mercedes-AMG

Design	Technology	Plug-In Hybrid	Model lines	Upholstery	Model prices	Mercedes-AMG	Mercedes-AMG prices	Mercedes-AMG upholstery	Personalisation	Standard equipment	Genuine accessories	Technical data	Additional information
--------	------------	----------------	-------------	------------	--------------	--------------	---------------------	-------------------------	-----------------	--------------------	---------------------	----------------	------------------------





Book a test drive



Buy your GLE SUV



Find a Retailer

# Mercedes-AMG GLE Model lines overview



Mercedes-AMG GLE 53 4MATIC+ Premium »



Mercedes-AMG GLE 63 S 4MATIC+ »



Mercedes-AMG GLE 53 4MATIC+ Premium Plus »



Design	Technology	Plug-In Hybrid	Model lines	Upholstery	Model prices	Mercedes-AMG	Mercedes-AMG prices	Mercedes-AMG upholstery	Personalisation	Standard equipment	Genuine accessories	Technical data	Additional information
--------	------------	----------------	-------------	------------	--------------	--------------	---------------------	-------------------------	-----------------	--------------------	---------------------	----------------	------------------------

# Mercedes-AMG GLE 53 4MATIC+ Premium Standard equipment highlights



OTR from **£81,135<sup>1</sup>**

<sup>1</sup>The recommended on-the-road price includes the Road Fund Licence applicable to the standard model plus delivery charge (£730.00 incl. VAT), new vehicle registration fee (£55.00), fuel (£50.00 incl. VAT), and number plates (£25.00 incl. VAT). VAT is calculated at the standard rate of 20%. Some of the model features, optional extras and colours shown may not be available, or may only be available in a different specification, or at a different price



### Engine, Transmission and Suspension

- AMG DYNAMIC SELECT with a choice of driving modes
- AMG RIDE CONTROL sports suspension based on AIR BODY CONTROL air suspension

### Exterior

- 21" AMG alloy wheels – 5-twin-spoke design, painted titanium grey with a high-sheen finish (code RWD)
- Adaptive Highbeam Assist
- Aluminium-look illuminated running boards with rubber studs
- AMG bodystyling – front apron with distinctive air intakes, AMG side sill panels and AMG rear apron with diffuser look
- 'AMG' lettering on front brake callipers
- AMG Performance exhaust
- AMG-specific radiator grille
- 'BITURBO 4MATIC+' lettering on front wings
- Heat-insulating dark-tinted glass
- Lights – LED High Performance headlamps
- Mild hybrid with 48-volt on-board electrical system
- Mirror package
- Summer tyres



Design	Technology	Plug-In Hybrid	Model lines	Upholstery	Model prices	Mercedes-AMG	Mercedes-AMG prices	Mercedes-AMG upholstery	Personalisation	Standard equipment	Genuine accessories	Technical data	Additional information
--------	------------	----------------	-------------	------------	--------------	--------------	---------------------	-------------------------	-----------------	--------------------	---------------------	----------------	------------------------





**Interior**

- Dashboard and door beltlines in ARTICO man-made leather
- Front door sill panels with 'AMG' lettering
- Floor mats – with black leather edging and AMG logo
- Memory package
- Multifunction sports steering wheel in nappa leather
- Third row of seats with four-zone THERMOTRONIC automatic climate control

**Communications, Safety and Assistance Systems**

- 12.3-inch touchscreen media display
- 12.3-inch digital instrument cluster
- MBUX multimedia system
- Parking package with 360° camera
- Red seat belts
- Smartphone integration<sup>1</sup> including Apple® CarPlay® and Android Auto™
- URBAN GUARD vehicle protection

<sup>1</sup>Compatible mobile phone required



Front door sill panels with 'AMG' lettering



THERMOTRONIC automatic climate control

**Trim and Upholstery**

Anthracite open-pore oak wood trim

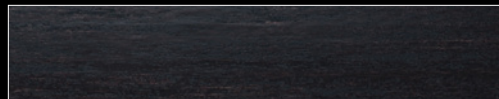

AMG nappa leather – black

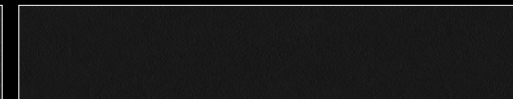

Design	Technology	Plug-In Hybrid	Model lines	Upholstery	Model prices	Mercedes-AMG	Mercedes-AMG prices	Mercedes-AMG upholstery	Personalisation	Standard equipment	Genuine accessories	Technical data	Additional information
--------	------------	----------------	-------------	------------	--------------	--------------	---------------------	-------------------------	-----------------	--------------------	---------------------	----------------	------------------------

# Mercedes-AMG GLE 53 4MATIC+ Premium Plus Standard equipment highlights



OTR from **£87,130<sup>1</sup>**  
 Upgrade price from Mercedes-AMG GLE 53 4MATIC+ Premium £5,995

In addition to/replacement of Mercedes-AMG GLE53 4MATIC+ Premium:

**Exterior**

22" AMG alloy wheels – cross-spoke design, painted matt black with a high-sheen rim flange (code RXV)

AMG Night package – exterior elements in high-gloss black: front splitter and trim strip in the AMG front apron, exterior mirror housing, window weatherstrips, trim strip in AMG rear apron, two black chrome-plated twin tailpipe trim elements

AMG switchable performance exhaust

KEYLESS-GO Comfort package

Panoramic glass sunroof

Summer tyres



<sup>1</sup>The recommended on-the-road price includes the Road Fund Licence applicable to the standard model plus delivery charge (£730.00 incl. VAT), new vehicle registration fee (£55.00), fuel (£50.00 incl. VAT), and number plates (£25.00 incl. VAT). VAT is calculated at the standard rate of 20%. Some of the model features, optional extras and colours shown may not be available, or may only be available in a different specification, or at a different price

Design	Technology	Plug-In Hybrid	Model lines	Upholstery	Model prices	Mercedes-AMG	Mercedes-AMG prices	Mercedes-AMG upholstery	Personalisation	Standard equipment	Genuine accessories	Technical data	Additional information
--------	------------	----------------	-------------	------------	--------------	--------------	---------------------	-------------------------	-----------------	--------------------	---------------------	----------------	------------------------





Blind Spot Assist

### Interior

AMG DRIVE UNIT

### Communications, Safety and Assistance Systems

Blind Spot Assist

Burmester® surround sound system

DISTRONIC

Driving Assistance package<sup>1</sup>

### Trim and Upholstery

Anthracite open-pore oak wood trim

AMG nappa leather – black

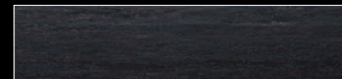

<sup>1</sup>Our driver assistance and safety systems are aids and do not relieve you of your responsibility as the driver. Please take note of the information in the Owner's Manual and the system limits which are described therein

Design	Technology	Plug-In Hybrid	Model lines	Upholstery	Model prices	Mercedes-AMG	Mercedes-AMG prices	Mercedes-AMG upholstery	Personalisation	Standard equipment	Genuine accessories	Technical data	Additional information
--------	------------	----------------	-------------	------------	--------------	--------------	---------------------	-------------------------	-----------------	--------------------	---------------------	----------------	------------------------

# Mercedes-AMG GLE 63 S 4MATIC+ Standard equipment highlights



In addition to/replacement of Mercedes-AMG GLE 53 4MATIC+ Premium Plus:

### Engine, Transmission and Suspension

DYNAMIC SELECT with a choice of driving modes: 'Slippery', 'Comfort', 'Sport', 'Sport+' and 'Individual'

Suspension with adaptive damping system

### Exterior

22" AMG alloy wheels – cross-spoke design, painted matt black with a high-sheen rim flange (code RXV)

Adaptive Highbeam Assist Plus

Exterior mirrors – high-gloss black

Lights – MULTIBEAM LED headlamps

Red brake callipers with 'AMG' lettering

Summer tyres



OTR from **£120,725<sup>1</sup>**

<sup>1</sup>The recommended on-the-road price includes the Road Fund Licence applicable to the standard model plus delivery charge (£730.00 incl. VAT), new vehicle registration fee (£55.00), fuel (£50.00 incl. VAT), and number plates (£25.00 incl. VAT). VAT is calculated at the standard rate of 20%. Some of the model features, optional extras and colours shown may not be available, or may only be available in a different specification, or at a different price

Design	Technology	Plug-In Hybrid	Model lines	Upholstery	Model prices	Mercedes-AMG	Mercedes-AMG prices	Mercedes-AMG upholstery	Personalisation	Standard equipment	Genuine accessories	Technical data	Additional information
--------	------------	----------------	-------------	------------	--------------	--------------	---------------------	-------------------------	-----------------	--------------------	---------------------	----------------	------------------------





### Interior

Ambient lighting - 64 colours - all colours can be selected individually

Dashboard and door beltlines in nappa leather

DINAMICA microfibre roof liner in black

Interior Chrome package

Multifunction sports steering wheel in nappa leather/ DINAMICA microfibre

Seats - climatized and multi-contour front seats with comfort head restraints

THERMOTRONIC four-zone climate control

### Communications, Safety and Assistance Systems

Additional USB ports

DAB digital radio tuner

Head-up display

### Trim and Upholstery

AMG carbon-fibre trim



AMG Exclusive nappa leather - magma grey/black



Design	Technology	Plug-In Hybrid	Model lines	Upholstery	Model prices	Mercedes-AMG	Mercedes-AMG prices	Mercedes-AMG upholstery	Personalisation	Standard equipment	Genuine accessories	Technical data	Additional information
--------	------------	----------------	-------------	------------	--------------	--------------	---------------------	-------------------------	-----------------	--------------------	---------------------	----------------	------------------------



Book a test drive



Buy your GLE SUV



Find a Retailer

# Become the AMG expert

Unleash a new level of performance.



Step into the world of performance and experience the AMG brand at Mercedes-Benz World – from the powerful sound of the engines to the smell of the leather to the unmistakable design of our vehicles.

Mercedes-Benz World invites all Mercedes-AMG customers to a complimentary adrenaline-packed driving experience. Feel the sensational AMG driving performance, develop your driving skills and even try your hand at power-sliding on the Wet Skid Circle. With expert one-to-one guidance from a Driving Specialist in the passenger seat, experience every inch of our Handling Circuits, Dynamic Straight and low friction surfaces.

[Click here for more information](#)



#### TERMS AND CONDITIONS

The following customers only are eligible: The first purchaser/ registered keeper of a newly registered Mercedes-AMG. The complimentary Training must be booked and taken within 12 months of delivery of your Mercedes-AMG, the Training is offered on specific days only and subject to availability. Upgrades are available for an additional cost, details upon request. Transferable to individuals who reside at the same postal address only. Mercedes-Benz Cars UK Limited reserves the right to amend or withdraw this Training experience. Attendees must hold a full UK driving licence. Attendees will be required to sign the Mercedes-Benz World Driving Risk Acknowledgement prior to undertaking the Training experience. The Training experience is also subject to the Mercedes-Benz World Terms and Conditions, as applicable. Invitation is emailed to the customer post-delivery, permission via the customer contact preferences must be given to enable Mercedes-Benz World to contact. Retailer demonstrator vehicles are not eligible.

Design	Technology	Plug-In Hybrid	Model lines	Upholstery	Model prices	Mercedes-AMG	Mercedes-AMG prices	Mercedes-AMG upholstery	Personalisation	Standard equipment	Genuine accessories	Technical data	Additional information
--------	------------	----------------	-------------	------------	--------------	--------------	---------------------	-------------------------	-----------------	--------------------	---------------------	----------------	------------------------



[Book a test drive](#)[Buy your GLE SUV](#)[Find a Retailer](#)

# Mercedes-AMG prices

Model line	Engine	Transmission	Seats	CO <sub>2</sub> WLTP <sup>1</sup> *	Basic RRP excl. VAT (£)	Total RRP incl. VAT (£)	Road Fund Licence (£) <sup>2</sup> WLTP	Rec. OTR price (£) <sup>3</sup> WLTP	P11D value (£)	BiK tax rate 2022/23 (%) <sup>2</sup>
Mercedes-AMG GLE53 4MATIC+ Premium	Petrol – 2,999 cc, 6-cylinder, 435 hp/320 kW Mild hybrid drive – 22 hp/16 kW	9G-TRONIC 9-speed automatic	7	246	65,225.00	78,270.00	2,005.00	<b>81,135.00</b>	79,075.00	37
Mercedes-AMG GLE53 4MATIC+ Premium Plus	Petrol – 2,999 cc, 6-cylinder, 435 hp/320 kW Mild hybrid drive – 22 hp/16 kW	9G-TRONIC 9-speed automatic	7	247	70,220.83	84,265.00	2,005.00	<b>87,130.00</b>	85,070.00	37
Mercedes-AMG GLE 63 S 4MATIC+	Petrol – 3,982 cc, 8-cylinder, 612 hp/450 kW Mild hybrid drive – 22 hp/16 kW	9G-TRONIC 9-speed automatic	5	281	97,925.00	117,510.00	2,355.00	<b>120,725.00</b>	118,315.00	37

<sup>1</sup>The indicated values were determined according to the prescribed measurement method - Worldwide Harmonised Light Vehicle Test Procedure (WLTP). Figures shown may include options which are not available in the UK. <sup>2</sup>Figures shown are for comparability purposes; only compare with other cars tested to the same technical procedures. Figures may not reflect real life driving results, which will depend upon a number of factors including factory-fitted options, accessories fitted (post registration), variations in weather, driving styles and vehicle load. Further information about the test used to establish fuel consumption and CO<sub>2</sub> figures can be found at <http://www.mercedes-benz.co.uk/WLTP> <sup>3</sup>A different first year rate of Vehicle Excise Duty (Road Fund Licence) applies for new cars. Please refer to page 54 for the relevant rate for the second and subsequent years <sup>4</sup>The recommended on-the-road price includes the Road Fund Licence applicable to the standard model plus delivery charge (£730.00 incl. VAT), new vehicle registration fee (£55.00), fuel (£50.00 incl. VAT), and number plates (£25.00 incl. VAT). VAT is calculated at the standard rate of 20%. Some of the model features, optional extras and colours shown may not be available, or may only be available in a different specification, or at a different price

Design	Technology	Plug-In Hybrid	Model lines	Upholstery	Model prices	Mercedes-AMG	Mercedes-AMG prices	Mercedes-AMG upholstery	Personalisation	Standard equipment	Genuine accessories	Technical data	Additional information
--------	------------	----------------	-------------	------------	--------------	--------------	---------------------	-------------------------	-----------------	--------------------	---------------------	----------------	------------------------

[Book a test drive](#)[Buy your GLE SUV](#)[Find a Retailer](#)

# Mercedes-AMG upholstery



Standard
  No-cost option
  Not available



**851A AMG nappa leather<sup>1</sup> - black**

Mercedes-AMG GLE53 4MATIC+ Premium	<input checked="" type="radio"/>
Mercedes-AMG GLE53 4MATIC+ Premium Plus	<input checked="" type="radio"/>
Mercedes-AMG GLE63 S 4MATIC+	<input type="checkbox"/>



**571A AMG Exclusive nappa leather<sup>1</sup> - magma grey/black**

Mercedes-AMG GLE53 4MATIC+ Premium	<input type="checkbox"/>
Mercedes-AMG GLE53 4MATIC+ Premium Plus	<input type="checkbox"/>
Mercedes-AMG GLE63 S 4MATIC+	<input checked="" type="radio"/>



**551A AMG Exclusive nappa leather<sup>1</sup> - black**

Mercedes-AMG GLE53 4MATIC+ Premium	<input type="checkbox"/>
Mercedes-AMG GLE53 4MATIC+ Premium Plus	<input type="checkbox"/>
Mercedes-AMG GLE63 S 4MATIC+	<input type="checkbox"/>

<sup>1</sup>100% of seat upholstery is pure leather

Design	Technology	Plug-In Hybrid	Model lines	Upholstery	Model prices	Mercedes-AMG	Mercedes-AMG prices	Mercedes-AMG upholstery	Personalisation	Standard equipment	Genuine accessories	Technical data	Additional information
--------	------------	----------------	-------------	------------	--------------	--------------	---------------------	-------------------------	-----------------	--------------------	---------------------	----------------	------------------------



# Colour options

Standard  No-cost option

Total prices incl. VAT



197 obsidian black metallic



859 mojave silver metallic



989 emerald green metallic



799 MANUFAKTUR diamond white metallic

£695.00



149 polar white non-metallic



922 high-tech silver metallic



992 selenite grey metallic



996 MANUFAKTUR hyacinth red metallic

£695.00

Please note that, owing to limitations of on-screen representation, paint colours may differ from those shown

Design	Technology	Plug-In Hybrid	Model lines	Upholstery	Model prices	Mercedes-AMG	Mercedes-AMG prices	Mercedes-AMG upholstery	Personalisation	Standard equipment	Genuine accessories	Technical data	Additional information
--------	------------	----------------	-------------	------------	--------------	--------------	---------------------	-------------------------	-----------------	--------------------	---------------------	----------------	------------------------



# Towing package

The Towing package offers an electronically folding tow bar which increases the towing capacity up to 3,500 kg.

**Towing package** (code DP8) – designed as a package, including items as listed.

**Available on AMG Line Premium Plus 300 d, 350 de and 400 d**

**Total incl. VAT £1,500**

## Towing package comprises:

Electronically folding tow bar (includes 13-pin socket; ESC: Electronic Stability Control)

Increased towing capacity – max. 3,500 kg



<a href="#">Design</a>	<a href="#">Technology</a>	<a href="#">Plug-In Hybrid</a>	<a href="#">Model lines</a>	<a href="#">Upholstery</a>	<a href="#">Model prices</a>	<a href="#">Mercedes-AMG</a>	<a href="#">Mercedes-AMG prices</a>	<a href="#">Mercedes-AMG upholstery</a>	<a href="#">Personalisation</a>	<a href="#">Standard equipment</a>	<a href="#">Genuine accessories</a>	<a href="#">Technical data</a>	<a href="#">Additional information</a>
------------------------	----------------------------	--------------------------------	-----------------------------	----------------------------	------------------------------	------------------------------	-------------------------------------	---	---------------------------------	------------------------------------	-------------------------------------	--------------------------------	--



[Book a test drive](#)[Buy your GLE SUV](#)[Find a Retailer](#)

# Standard equipment

● Standard    – Not available

## Engine, Transmission and Suspension

	AMG Line Premium Plus	AMG Line Premium	AMG Line
9G-TRONIC 9-speed automatic transmission	●	●	●
AGILITY CONTROL suspension with selective damping system and lowering by 15 mm	●	●	●
AIRMATIC package – the vehicle's rear can be lowered by around 40 mm using a switch, for easier loading and unloading	–	–	●
DYNAMIC SELECT with a choice of driving modes: 'Eco', 'Comfort', 'Sport' and 'Individual'	●	●	●
ECO start/stop function	●	●	●
Mild hybrid with 48-volt on-board electrical system (300 d and 450 4MATIC only)	●	●	●

## Steering

Direct-Steer speed-sensitive steering	●	●	●
Steering column – manually adjustable for height and reach	●	●	●
Steering wheel – AMG 3-spoke multifunction steering wheel with touch control buttons, trimmed in black nappa leather with flattened bottom section	●	●	●
Steering wheel – multifunction, with gearshift paddles	●	●	●
Steering wheel – touch-control buttons for audio and onboard settings	●	●	●

## Exterior

65-litre fuel tank (Hybrid only)	●	●	●
85-litre fuel tank (excluding Hybrid)	●	●	●
Adaptive Highbeam Assist	●	●	●
Aluminium-look illuminated running boards with rubber studs	●	●	●
AMG bodystyling – front and rear aprons, side skirts in polished aluminium	●	●	●
EASY PACK tailgate: open/close the boot lid from the driver's seat when the vehicle is stationary and unlocked	●	●	●

	AMG Line Premium Plus	AMG Line Premium	AMG Line
Exhaust system – visible twin-pipe exhaust trims integrated into rear bumper	●	●	●
Exterior mirrors – body colour	●	●	●
Exterior mirrors – heated and electronically adjustable	●	●	●
KEYLESS-GO Comfort package	–	–	●
Lights – LED High Performance headlamps	●	●	●
Lights – LED rear lights	●	●	●
Mirror package – electrically folding mirrors, automatically-dimming driver's exterior mirror and rear view mirror, and image projection logo	●	●	●
Panoramic glass sunroof	–	–	●
Parking – Parking package including 360° camera	–	●	●
Parking – Parking package including Active Parking Assist, with front and rear parking sensors. The system automatically steers the vehicle into parking spaces. Bay parking capable	●	●	●
Perforated front brake discs and brake callipers with 'Mercedes-Benz' lettering	●	●	●
Privacy glass – heat-insulating dark-tinted glass	●	●	●
Radiator grille with integrated star – single louvre in matt iridium silver with chrome trim	●	●	●
Rain-sensing windscreen wipers	●	●	●
Reversing camera	●	–	–
Roof rail systems	●	●	●
Tinted glass, green – front	●	●	●
TIREFIT with tyre inflation compressor	●	●	●
Top surround of side windows in polished aluminium	●	●	●
Waistline in polished aluminium	●	●	●

[Book a test drive](#)[Buy your GLE SUV](#)[Find a Retailer](#)

# Standard equipment

● Standard    – Not available

## Wheels

20" AMG alloy wheels – 5-twin-spoke design, painted tremolite grey with high-sheen finish, 275/50 tyres (code RZV)

21" AMG alloy wheels – multi-spoke design, painted black with a high-sheen finish, 275/45 (front) and 315/40 (rear) tyres (code RWB)

22" AMG alloy wheels – 5-twin-spoke design, painted black with a high-sheen finish, 285/40 (front) and 325/35 (rear) tyres (350 de/400 d/450, code RXT)

Summer tyres with noise-reducing foam absorber

	AMG Line Premium Plus	AMG Line Premium	AMG Line
20" AMG alloy wheels – 5-twin-spoke design, painted tremolite grey with high-sheen finish, 275/50 tyres (code RZV)	●	–	–
21" AMG alloy wheels – multi-spoke design, painted black with a high-sheen finish, 275/45 (front) and 315/40 (rear) tyres (code RWB)	–	●	–
22" AMG alloy wheels – 5-twin-spoke design, painted black with a high-sheen finish, 285/40 (front) and 325/35 (rear) tyres (350 de/400 d/450, code RXT)	–	–	●
Summer tyres with noise-reducing foam absorber	●	●	●

## Interior

Ambient lighting – 64 colours

Automatic climate control – four-zone

Automatic climate control – two-zone

Central stowage compartment with 12V socket in centre console. Replaced with USB socket in conjunction with optional wireless charging

Charging cable for wallbox and public charging stations (mode 3) – 8 metres, 16 A (350 de only)

Courtesy lights in rear grab handles with reading light functionality

Door pins in chrome

Electric windows (4) – with one-touch opening and closing, including obstruction sensors

Electronic key – chrome surround

Floor mats with 'AMG' lettering

Front centre armrest with stowage compartment and illuminated grab handles

Ambient lighting – 64 colours	●	●	●
Automatic climate control – four-zone	–	●	●
Automatic climate control – two-zone	●	–	–
Central stowage compartment with 12V socket in centre console. Replaced with USB socket in conjunction with optional wireless charging	●	●	●
Charging cable for wallbox and public charging stations (mode 3) – 8 metres, 16 A (350 de only)	●	●	●
Courtesy lights in rear grab handles with reading light functionality	●	●	●
Door pins in chrome	●	●	●
Electric windows (4) – with one-touch opening and closing, including obstruction sensors	●	●	●
Electronic key – chrome surround	●	●	●
Floor mats with 'AMG' lettering	●	●	●
Front centre armrest with stowage compartment and illuminated grab handles	●	●	●

Front door sill panels with 'AMG' lettering – illuminated

Glasses compartment in overhead control panel

Glove compartment – lockable, air conditioned and illuminated

Head restraints for driver and front passenger (four-way adjustability) and in rear (two-way)

Illuminated stainless steel door sill panels with 'Mercedes-Benz' lettering

Instrument cluster – widescreen (12.3-inch) cockpit display – high resolution screen with choice of three display styles and unique ambient lighting settings based on display styles 'Classic', 'Progressive' or 'Sport'

Head restraints for driver and front passenger (four-way adjustability) and in rear (two-way)

KEYLESS-GO starting function

Outside temperature display

Seats – front, four-way fully-electric seat adjustment

Seats – front, heated

Seats – second row, three seats (5 seats)

Seats – second row, three seats, electronically adjustable (7 seats)

Seats – second row, split folding 40:20:40

Seats – third row of seats for two people (7 seats) (400 d only)

Service indicator ASSYST

Sports pedals in brushed stainless steel with rubber studs

Sun visors with illuminated vanity mirrors

Trip computer in multifunction display showing current fuel consumption

	AMG Line Premium Plus	AMG Line Premium	AMG Line
Front door sill panels with 'AMG' lettering – illuminated	●	●	●
Glasses compartment in overhead control panel	●	●	●
Glove compartment – lockable, air conditioned and illuminated	●	●	●
Head restraints for driver and front passenger (four-way adjustability) and in rear (two-way)	●	●	●
Illuminated stainless steel door sill panels with 'Mercedes-Benz' lettering	●	●	●
Instrument cluster – widescreen (12.3-inch) cockpit display – high resolution screen with choice of three display styles and unique ambient lighting settings based on display styles 'Classic', 'Progressive' or 'Sport'	●	●	●
Head restraints for driver and front passenger (four-way adjustability) and in rear (two-way)	●	●	●
KEYLESS-GO starting function	●	●	●
Outside temperature display	●	●	●
Seats – front, four-way fully-electric seat adjustment	●	●	●
Seats – front, heated	●	●	●
Seats – second row, three seats (5 seats)	●	●	●
Seats – second row, three seats, electronically adjustable (7 seats)	●	●	●
Seats – second row, split folding 40:20:40	●	●	●
Seats – third row of seats for two people (7 seats) (400 d only)	●	●	●
Service indicator ASSYST	●	●	●
Sports pedals in brushed stainless steel with rubber studs	●	●	●
Sun visors with illuminated vanity mirrors	●	●	●
Trip computer in multifunction display showing current fuel consumption	●	●	●

\*If you are planning to charge your Mercedes-Benz plug-in electric vehicle using a 3-pin domestic plug socket you must get a qualified electrician to inspect and sign off the socket to confirm it is safe and suitable to charge your vehicle. Do not use an electric vehicle 3-pin charge cable with an extension cord

Design	Technology	Plug-In Hybrid	Model lines	Upholstery	Model prices	Mercedes-AMG	Mercedes-AMG prices	Mercedes-AMG upholstery	Personalisation	Standard equipment	Genuine accessories	Technical data	Additional information
--------	------------	----------------	-------------	------------	--------------	--------------	---------------------	-------------------------	-----------------	--------------------	---------------------	----------------	------------------------



[Book a test drive](#)[Buy your GLE SUV](#)[Find a Retailer](#)

# Standard equipment

● Standard    – Not available

## Paint, Trim and Upholstery

	AMG Line Premium Plus	AMG Line Premium	AMG Line
Paint – metallic	●	●	●
Roof liner – black fabric	●	●	●
Trim – centre console, anthracite open-pore oak wood trim	●	●	●
Trim – dashboard and door, anthracite open-pore oak wood trim	●	●	●
Trim – upper dashboard, ARTICO man-made leather with contrast topstitching	●	●	●
Upholstery – nappa leather	●	●	●

## Safety and Assistance Systems

Active bonnet – pedestrian safety measure which detects an impact and raises bonnet	●	●	●
Active Braking Assist <sup>1</sup>	●	●	●
Adaptive brake lights	●	●	●
Adaptive Brake System with HOLD function and brake drying in the wet	●	●	●
Airbags – driver and front passenger, with extended adaptivity for front passenger airbag	●	●	●
Airbag – kneebag for driver	●	●	●
Airbags – sidebag for driver and front passenger (combined thorax/pelvis bag)	●	●	●
Airbags – windowbags	●	●	●
Alarm system with immobiliser and interior protection	●	●	●
Anti-lock braking system (ABS)	●	●	●
Attention Assist – can help alert to long journey fatigue	●	●	●
Automatic child seat recognition sensor	●	●	●
Blind Spot Assist	●	●	●

	AMG Line Premium Plus	AMG Line Premium	AMG Line
Brake wear warning display	●	●	●
Central locking with interior switch, automatic locking and crash sensor with emergency opening function	●	●	●
Childproof locks – manually operated for rear doors and electrically operated for rear power windows	●	●	●
Cruise control with variable speed limiter	●	●	●
Diesel Particulate Filter (DPF) – diesel models only	●	●	●
DISTRONIC	–	–	●
Driving Assistance package <sup>1</sup>	–	–	●
Electronic parking brake	●	●	●
Electronic Stability Programme (ESP®) with Acceleration Skid Control (ASR)	●	●	●
First-aid kit, warning triangle and high visibility jacket	●	●	●
Incorrect fuelling protection – diesel models only	●	●	●
ISOFIX second row child seat attachment points – two outer rear seats	●	●	●
Lane-Keeping Assist	●	●	●
Mercedes-Benz emergency call system	●	●	●
Petrol Particulate Filter (PPF) – petrol models only	–	●	●
PRE-SAFE® anticipatory safety system	●	●	●
Remote boot release	●	●	●
Seat belts – three-point	●	●	●
Seat occupancy sensor for front passenger seat	●	●	●
Speed Limit Assist	●	●	●
Status display for rear seat belts in instrument cluster	●	●	●

<sup>1</sup>Our driver assistance and safety systems are aids and do not relieve you of your responsibility as the driver. Please take note of the information in the Owner's Manual and the system limits which are described therein

[Book a test drive](#)[Buy your GLE SUV](#)[Find a Retailer](#)

# Standard equipment

● Standard    – Not available

## Safety and Assistance Systems (continues)

	AMG Line Premium Plus	AMG Line Premium	AMG Line
Traffic Sign Assist – traffic sign recognition including wrong-way warning function and display of posted speed limits in the instrument cluster	●	●	●
Tyre pressure monitoring and loss warning system	●	●	●
URBAN GUARD vehicle protection	●	●	●

## Communications and In-Car Entertainment

	AMG Line Premium Plus	AMG Line Premium	AMG Line
Aerial for GPS	●	●	●
DAB digital radio tuner	●	●	●
Dual Bluetooth® interface, 2 USB ports (type C)	●	●	●
Hard-disk navigation	●	●	●
“Hey Mercedes” voice activation	●	●	●
Live Traffic Information (free for first three years)	●	●	●
MBUX multimedia system	●	●	●
Media display – high-resolution 12.3-inch touchscreen display	●	●	●
Mercedes me connect (standard services) including emergency call system (eCall), accident recovery, breakdown and maintenance management	●	●	●
Mercedes me connect (vehicle monitoring) with free of charge for first three years - extension possible and pricing information available via Mercedes me store. Geofencing, parked vehicle locator, vehicle monitoring, vehicle tracker	●	●	●
Radio aerial integrated into rear window	●	●	●
Smartphone integration <sup>1</sup> including Apple® CarPlay® and Android Auto™	●	●	●

<sup>1</sup>Compatible mobile phone required. Please check [www.mercedes-benz-mobile.com](http://www.mercedes-benz-mobile.com) for details or contact your local Mercedes-Benz Retailer for further information



[Book a test drive](#)[Buy your GLE SUV](#)[Find a Retailer](#)

# Standard equipment Mercedes-AMG

● Standard    – Not available

## Engine, Transmission and Suspension

	GLE53 4MATIC+ Premium Plus	GLE53 4MATIC+ Premium	GLE63 S 4MATIC+
AGILITY CONTROL suspension with selective damping system and lowering by 15 mm	●	●	–
AMG ACTIVE RIDE CONTROL sports suspension based on AIR BODY CONTROL air suspension	●	●	–
AMG RIDE CONTROL+ sports suspension	–	–	●
AMG SPEEDSHIFT TCT 9-speed automatic transmission	●	●	●
DYNAMIC SELECT with a choice of driving modes: 'Eco', 'Comfort', 'Sport' and 'Individual'	●	●	–
DYNAMIC SELECT with a choice of driving modes: 'Slippery', 'Comfort', 'Sport', 'Sport+' and 'Individual'	–	–	●
ECO start/stop function	●	●	●
Mild hybrid with 48-volt on-board electrical system	●	●	●
Permanent four-wheel drive	●	●	●
Suspension - AGILITY CONTROL suspension with selective damping system and lowering by 15 mm	●	●	–
Suspension - with adaptive damping system	–	–	●

## Steering

Sports Direct-Steer system with speed-sensitive power assistance	●	●	●
Steering column - electrically adjustable for height and rear	●	●	●
Steering wheel - 3-spoke design with flattened bottom section	●	●	●
Steering wheel - multifunction sports steering wheel in nappa leather	●	●	–
Steering wheel - multifunction sports steering wheel in nappa leather/DINAMICA microfibre	–	–	●
Steering wheel - multifunction, with gearshift paddles	●	●	●
Steering wheel - touch-control buttons for audio and onboard settings	●	●	●

## Exterior

	GLE53 4MATIC+ Premium Plus	GLE53 4MATIC+ Premium	GLE63 S 4MATIC+
85-litre fuel tank	●	●	●
Adaptive Highbeam Assist	●	●	–
Adaptive Highbeam Assist Plus	–	–	●
Aluminium-look illuminated running boards with rubber studs	●	●	●
AMG bodystyling - front and rear aprons, side skirts in polished aluminium	●	●	●
AMG Night package	–	●	●
AMG Performance exhaust	●	●	●
AMG specific radiator grille with vertical bars in high-gloss chrome and AMG logo	●	●	●
'BITURBO 4MATIC+' lettering on front wings	●	●	●
EASYPACK tailgate - open/close the boot lid from the driver's seat when the vehicle is stationary and unlocked	●	●	●
Exhaust system - AMG Performance exhaust	●	●	●
Exhaust system - visible twin-pipe exhaust trims integrated into rear bumper	●	●	●
Exterior mirrors - body colour	●	●	–
Exterior mirrors - heated and electronically adjustable	●	●	●
Exterior mirrors - high-gloss black	–	–	●
KEYLESS-GO Comfort package	–	●	●
Lights - LED rear lights	●	●	●
Lights - LED High Performance headlamps	●	●	–
Lights - MULTIBEAM LED headlamps	–	–	●
Mirror package - electrically folding mirrors, automatically-dimming driver's exterior mirror and rear view mirror, and image projection logo	●	●	●
Parking - Parking package including Active Parking Assist, with 360° camera. The system automatically steers the vehicle into parking spaces. Bay parking capable	●	●	●

[Book a test drive](#)[Buy your GLE SUV](#)[Find a Retailer](#)

# Standard equipment Mercedes-AMG

● Standard    – Not available

## Exterior (continued)

	GLE53 4MATIC+ Premium Plus	GLE53 4MATIC+ Premium	GLE63 S 4MATIC+
Panoramic glass sunroof	–	●	●
Perforated front brake discs and anodised silver brake callipers with 'AMG' lettering	●	●	–
Privacy glass – heat-insulating dark-tinted glass	●	●	●
Rain-sensing windscreen wipers	●	●	●
Red brake callipers with 'AMG' lettering	–	–	●
Roof rail systems	●	●	●
Tinted glass, green – front	●	●	●
TIREFIT with tyre inflation compressor	●	●	●
Top surround of side windows in polished aluminium	●	●	●
URBAN GUARD vehicle protection	●	●	●
Waistline in polished aluminium	●	●	●

## Wheels

21" AMG alloy wheels – 5-twin-spoke design, painted titanium grey with a high-sheen finish (code RWD)	●	–	–
22" AMG alloy wheels – cross-spoke design, painted matt black with a high-sheen rim flange (code RXV)	–	●	●
Summer tyres with noise-reducing foam absorber	●	●	●

## Interior

Ambient lighting – 64 colours	●	●	●
Central stowage compartment with 12V socket in centre console. Replaced with USB socket in conjunction with optional wireless charging	●	●	●
Courtesy lights in rear grab handles with reading light functionality	●	●	●
Door pins in chrome	●	●	●

	GLE53 4MATIC+ Premium Plus	GLE53 4MATIC+ Premium	GLE63 S 4MATIC+
Electric windows (4) – with one-touch opening and closing, including obstruction sensors	●	●	●
Electronic key – chrome surround	●	●	●
Floor mats with 'AMG' lettering	●	●	●
Front centre armrest with stowage compartment and illuminated grab handles	●	●	●
Front door sill panels with 'AMG' lettering – illuminated	●	●	●
Glasses compartment in overhead control panel	●	●	●
Glove compartment – lockable, air conditioned and illuminated	●	●	●
Head restraints for driver and front passenger (four-way adjustability) and in rear (two-way)	●	●	●
Instrument cluster – widescreen (12.3-inch) cockpit display. High resolution screen with choice of three display styles and unique ambient lighting settings based on display styles 'Classic', 'Progressive' or 'Sport'	●	●	●
Instrument cluster – AMG main menu, including RACETIMER and AMG start-up display. Displays valuable information for sporty drivers presented in an inspiring AMG design. With RACETIMER it is possible to measure lap times	●	●	●
Interior Chrome package	–	–	●
KEYLESS-GO Comfort package – vehicle can be conveniently unlocked, started and locked with this system – simply by carrying the electronic key	–	●	●
Outside temperature display	●	●	●
Seats – climatised and multi-contour front seats with comfort head restraints	–	–	●
Seats – front, AMG sports seats	●	●	●
Seats – front, four-way fully-electric seat adjustment	●	●	●
Seats – front, heated	●	●	–
Seats – Memory package – driver's seat, front passenger seat, steering column and exterior mirrors – electrically adjustable with memory	●	●	●

[Book a test drive](#)[Buy your GLE SUV](#)[Find a Retailer](#)

# Standard equipment Mercedes-AMG

● Standard    – Not available

## Interior (continued)

	GLE53 4MATIC+ Premium Plus	GLE53 4MATIC+ Premium	GLE63 S 4MATIC+
Seats – second row, split folding 40:20:40	●	●	●
Seats – second row, three seats, electronically adjustable	●	●	●
Seats – third row of seats for two people	●	●	–
Service indicator ASSYST	●	●	●
Sports pedals in brushed stainless steel with rubber studs	●	●	●
Sun visors with illuminated vanity mirrors	●	●	●
THERMOTRONIC 4-zone climate control	●	●	●
Trip computer in multifunction display showing current fuel consumption	●	●	●

## Paint, Trim and Upholstery

Paint – metallic	●	●	●
Roof liner – black fabric	●	●	–
Roof liner – DINAMICA black	–	–	●
Trim – centre console, AMG carbon fibre trim	–	–	●
Trim – centre console, anthracite open-pore oak wood trim	●	●	–
Trim – dashboard and door, anthracite open-pore oak wood trim	●	●	–
Trim – dashboard and door, AMG carbon fibre trim	–	–	●
Trim – upper dashboard, ARTICO man-made leather with contrast topstitching	●	●	●
Trim – upper dashboard, nappa leather	–	–	●
Upholstery – AMG Exclusive nappa leather	–	–	●
Upholstery – AMG nappa leather	●	●	–
Upholstery – third row, ARTICO man-made leather	●	●	●

## Safety and Assistance Systems

	GLE53 4MATIC+ Premium Plus	GLE53 4MATIC+ Premium	GLE63 S 4MATIC+
Anti-Theft Protection package	●	●	●
Active bonnet – pedestrian safety measure which detects an impact and raises bonnet	●	●	●
Active Braking Assist <sup>1</sup>	●	●	●
Adaptive brake lights	●	●	●
Adaptive Brake System with HOLD function and brake drying in the wet	●	●	●
Airbags – driver and front passenger, with extended adaptivity for front passenger airbag	●	●	●
Airbag – kneebag for driver	●	●	●
Airbags – sidebag for driver and front passenger (combined thorax/pelvis bag)	●	●	●
Airbags – windowbags	●	●	●
Alarm system with immobiliser and interior protection	●	●	●
AMG high-performance composite braking system	–	–	●
Anti-lock braking system (ABS)	●	●	●
Attention Assist – can help alert to long journey fatigue	●	●	●
Automatic child seat recognition sensor	●	●	●
Blind Spot Assist	–	●	●
Brake wear warning display	●	●	●
Central locking with interior switch, automatic locking and crash sensor with emergency opening function	●	●	●
Childproof locks – manually operated for rear doors and electrically operated for rear power windows	●	●	●
Cruise control with variable speed limiter	●	●	●
DISTRONIC	–	●	●
Driving Assistance package <sup>1</sup>	–	●	●
Electronic parking brake	●	●	●

<sup>1</sup>Our driver assistance and safety systems are aids and do not relieve you of your responsibility as the driver. Please take note of the information in the Owner's Manual and the system limits which are described therein



[Book a test drive](#)[Buy your GLE SUV](#)[Find a Retailer](#)

# Standard equipment Mercedes-AMG

● Standard    – Not available

## Safety and Assistance Systems (continued)

	GLE53 4MATIC+ Premium Plus	GLE53 4MATIC+ Premium	GLE63 S 4MATIC+
Electronic Stability Programme (ESP®) with Acceleration Skid Control (ASR)	●	●	●
First-aid kit and warning triangle	●	●	●
ISOFIX second row child seat attachment points – two outer rear seats	●	●	●
Lane-Keeping Assist	●	●	●
Mercedes-Benz emergency call system	●	●	●
Petrol Particulate Filter (PPF)	●	●	●
PRE-SAFE® anticipatory safety system	●	●	●
Remote boot release	●	●	●
Remote central locking	–	●	●
Seat belts – three-point	●	●	●
Seat occupancy sensor for front passenger seat	●	●	●
Service indicator ASSYST	–	●	●
Speed Limit Assist	●	●	●
Status display for rear seat belts in instrument cluster	●	●	●
Traffic Sign Assist – traffic sign recognition including wrong-way warning function and display of posted speed limits in the instrument cluster	●	●	●
Tyre pressure monitoring and loss warning system	●	●	●

## Communications and In-Car Entertainment

	GLE53 4MATIC+ Premium Plus	GLE53 4MATIC+ Premium	GLE63 S 4MATIC+
Additional USB ports	–	–	●
Aerial for GPS	●	●	●
Burmester® surround sound system	–	●	●
DAB digital radio tuner	●	●	●
Dual Bluetooth® interface, 2 USB ports (type C)	●	●	●
Hard-disk navigation	●	●	●
Head-up display	–	–	●
“Hey Mercedes” voice activation	●	●	●
Live Traffic Information (free for first three years)	●	●	●
MBUX multimedia system	●	●	●
Media display – high-resolution 12.3-inch touchscreen display	●	●	●
Mercedes me connect (standard services) including emergency call system (eCall), accident recovery, breakdown and maintenance management	●	●	●
Mercedes me connect (vehicle monitoring) with free of charge for first three years - extension possible and pricing information available via Mercedes me store. Geofencing, parked vehicle locator, vehicle monitoring, vehicle tracker	●	●	●
Radio aerial integrated into rear window	●	●	●
Smartphone integration <sup>1</sup> including Apple® CarPlay® and Android Auto™	●	●	●

<sup>1</sup>Compatible mobile phone required. Please check [www.mercedes-benz-mobile.com](http://www.mercedes-benz-mobile.com) for details or contact your local Mercedes-Benz Retailer for further information

# Genuine accessories

We've developed a range of accessories you can add to help personalise and enhance your GLE.



### Alustyle bicycle rack

Extremely lightweight bicycle rack, designed to allow you to attach a bicycle to the basic carrier bars for roof rails. Bicycles can either be attached to the rack once it has been fitted to the roof or, conveniently, before it is fitted. The support frame can also be folded down when not in use to reduce drag when travelling without cycles. (A00890029364)



### Concertina load sill protector

Designed to prevent the bumper from being scratched. Can be secured to boot tub or reversible mat. Helps prevent scratches when loading the load compartment or when loading the Mercedes-Benz roof box. (A2536932000)



### Deep boot tub

The deep, fitted boot tub (approx. 25 cm at the sides, 8 cm at the load edge) is also suitable for transporting shopping. The HD-PE material is particularly tough yet flexible, as well as odourless, acid-resistant and easy-clean. Ribbed structure for added strength. Lightweight and easy to insert and remove. Cannot be used in conjunction with third row of seats or with hybrid vehicles. (A1678140200)



### Alustyle Easy-Fix II basic carrier bars for roof rails

Aluminium carrier bars, precision-tailored to the body of your Mercedes-Benz – the perfect basis for a range of Mercedes-Benz transport solutions: ski and snowboard rack, bicycle rack or roof boxes. (A1678903000)

### Mercedes-Benz roof box 450

An aerodynamic design, tailored to your Mercedes-Benz. In extremely durable material. Designed for quick, optimised attachment to the basic carrier bars. Particularly convenient loading and unloading thanks to the option of double-sided opening. Lockable from both sides. Available in various sizes. (A0008400200)



### Shallow boot tub

Suitable for transporting shopping. The tub shape with its slightly raised edge is precision-tailored to the load area. Made from impact-resistant, non-slip polypropylene. Cannot be used in conjunction with third row of seats or with hybrid vehicles. (A1678140100)

### Stowage crate

The robust plastic stowage box creates order in the boot. The box can be divided into two sections using the enclosed rigid dividing element and be combined with the Mercedes-Benz boot tub thanks to the ribbed structure at the bottom. Capacity: 51 litres. (A0008140400)

All the above accessories are subject to availability and compatibility. Please ask your Mercedes-Benz Retailer for more information

Design	Technology	Plug-In Hybrid	Model lines	Upholstery	Model prices	Mercedes-AMG	Mercedes-AMG prices	Mercedes-AMG upholstery	Personalisation	Standard equipment	Genuine accessories	Technical data	Additional information
--------	------------	----------------	-------------	------------	--------------	--------------	---------------------	-------------------------	-----------------	--------------------	---------------------	----------------	------------------------

[Book a test drive](#)[Buy your GLE SUV](#)[Find a Retailer](#)

# Technical data

● Standard    – Not available

Model	GLE 300 d 4MATIC	GLE 350 de 4MATIC	GLE 400 d 4MATIC	GLE 450 4MATIC	Mercedes-AMG GLE 53 4MATIC+	Mercedes-AMG GLE 63 S 4MATIC+
<b>Engine</b>						
Fuel delivery	Diesel	Diesel	Diesel	Petrol	Petrol	Petrol
Total displacement cc	1,993	1,950	2,925	2,999	2,999	3,982
Arrangement/cylinders/valves	in-line/4/16	in-line/4/16	in-line/6/24	in-line/6/24	in-line/6/24	V/8/32
Power <sup>1</sup> hp (kW) at rpm						
Combustion engine	272 (200)/4,200	194 (143)/3,800	330 (243)/3,600–4,200	367 (270)/5,500–6,100	435 (320)/5,500–6,100	612 (450)/5,750–6,500
Electric motor [Mild hybrid drive]	[20 (15)]	136 (100)	–	[22 (16)]	[22 (16)]	[22 (16)]
System output	–	320 (235)	–	–	–	–
Torque <sup>1</sup> Nm at rpm						
Combustion engine	550/1,800–2200	400/1,600–2,800	700/1,200–3,200	500/1,600–4,500	520/1,800–5,800	850/2,500–5,000
Electric motor [Mild hybrid drive]	–	440/0–2,000	–	–	–	–
System output	–	700/3,500–4,000	–	–	–	–
Compression ratio	15.5:1	15.5:1	15.5:1	10.5:1	10.5:1	8.6:1
Equivalent All-Electric Range (EAER) <sup>2</sup> mi	–	55–58	–	–	–	–
Battery type (usable) kWh	–	Lithium-ion/31.0	–	–	–	–
Power consumption, combined <sup>2</sup> kWh/100 km	–	29.3–27.7	–	–	–	–
AC charging time, 10–100% <sup>3</sup>						
At a wallbox (3.7 kW AC Single Phase)	–	6 hrs 45 mins	–	–	–	–
At a charging station (7.4 kW AC Three Phase)	–	3 hrs 30 mins	–	–	–	–
DC charging time, 10–80% (60 kW)	–	20 mins	–	–	–	–
Capacity on-board charger	–	3.7 kW (AC Single Phase)/ 7.4 kW (AC Three Phase)/ 60 kW (DC)	–	–	–	–
Emissions standard	EURO 6D-ISC-FCM	EURO 6D-ISC-FCM	EURO 6D-ISC-FCM	EURO 6D-ISC-FCM	EURO 6D-ISC-FCM	EURO 6D-ISC-FCM

<sup>1</sup>Figures according to Directive 80/1269/EEC in the currently applicable version    <sup>2</sup>The indicated values were determined according to the prescribed measurement method - Worldwide Harmonised Light Vehicle Test Procedure (WLTP). Figures shown may include options which are not available in the UK. For Plug-in Hybrid Electric Vehicle (PHEV) figures determined with the battery fully charged, using a combination of both battery power and fuel. These models require mains electricity for charging    <sup>3</sup>Specified voltage and current values refer to network infrastructure and can be limited by the vehicle



[Book a test drive](#)[Buy your GLE SUV](#)[Find a Retailer](#)

# Technical data

Model		GLE 300 d 4MATIC	GLE 350 de 4MATIC	GLE 400 d 4MATIC	GLE 450 4MATIC	Mercedes-AMG GLE 53 4MATIC+	Mercedes-AMG GLE 63 S 4MATIC+
<b>Transmission</b>							
9G-TRONIC PLUS 9-speed automatic		●	●	●	●	–	–
AMG SPEEDSHIFT TCT 9G automatic		–	–	–	–	●	●
<b>Performance</b>							
Acceleration 0–62 mph	sec	6.8	6.9	5.7	5.7	5.3	3.8
Top speed (electric mode)	mph	143	140 (87)	152	155	155 <sup>4</sup>	174 <sup>5</sup>
<b>Weights and capacities</b>							
Kerb weight <sup>6</sup>	kg	2,280	2,655	2,280	2,230	2,305	2,420
Perm. Gross Vehicle Weight	kg	3,000	3,260	3,070	3,000	3,050	3,120
Boot capacity – seats up/seats down	l	630/2,055	490/1,915	630/2,055	630/2,055	630/2,055	630/2,055
Towing capacity – unbraked/braked with Towing package	kg	750/2,700 3,500	750/2,700 3,500	750/2,700 3,500	750/2,700 3,500	750/3,500 –	750/3,500 –
Fuel tank capacity/of which reserve	l	85/9	65/9	85/9	85/9	85/9	85/12.0
Turning circle	m	12.02	12.02	12.02	12.02	12.40	12.40
<b>Fuel consumption<sup>6,7,8</sup></b>							
Combined (consumption dependent on chosen optional equipment)	l/100 km mpg	7.2–6.3 39.2–44.8	0.9–0.8 313.9–353.1	8.4–7.9 33.6–35.8	10.1–9.8 28.0–28.8	10.9–10.8 25.9–26.2	12.4 22.8
<b>Insurance</b>							
Group rating		tba	tba	tba	tba	tba	tba

Insurance ratings may vary depending on model line and specification. Please refer to <http://www.thatcham.org/abigrouprating/> for further details

<sup>4</sup>Electronically limited <sup>5</sup>Figures according to Directive 92/21/EC (kerb weight with fuel tank 90% full, driver, 68 kg, and luggage, 7 kg) for standard-specification vehicles. Optional extras and accessories will generally increase this figure and reduce the payload capacity accordingly <sup>6</sup>All figures are based on a standard specification with the smallest tyre size <sup>7</sup>The choice of wheels and transmission may affect CO<sub>2</sub> emissions and corresponding Road Fund Licence <sup>8</sup>The indicated values were determined according to the prescribed measurement method – Worldwide Harmonised Light Vehicle Test Procedure (WLTP). Figures shown may include options which are not available in the UK. Figures shown are for comparability purposes; only compare with other cars tested to the same technical procedures. Figures may not reflect real life driving results, which will depend upon a number of factors including factory-fitted options, accessories fitted (post registration), variations in weather, driving styles and vehicle load. Further information about the test used to establish fuel consumption and CO<sub>2</sub> figures can be found at <http://www.mercedes-benz.co.uk/WLTP>



Book a test drive



Buy your GLE SUV



Find a Retailer

## AMG Line

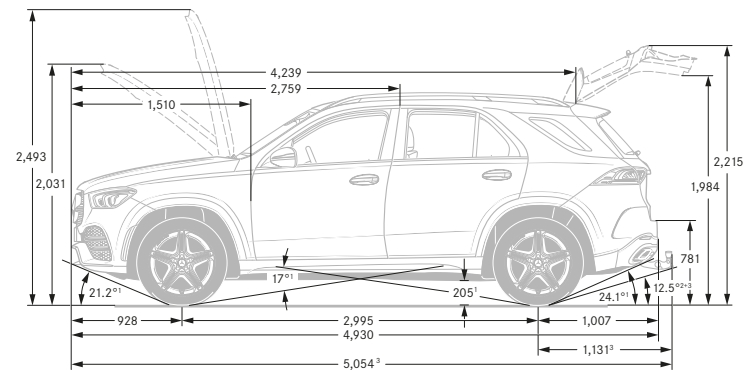
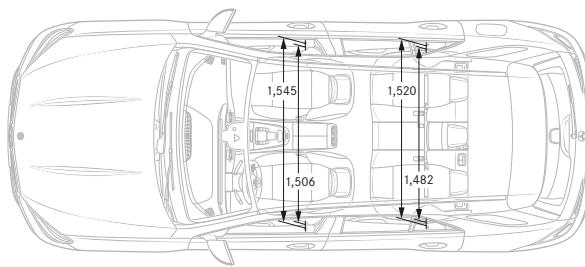
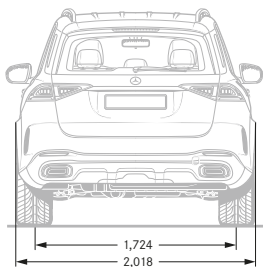
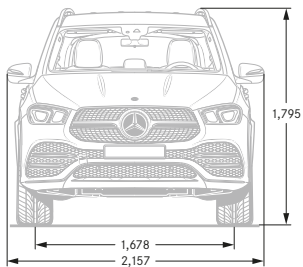

## Mercedes-AMG GLE 53 4MATIC+

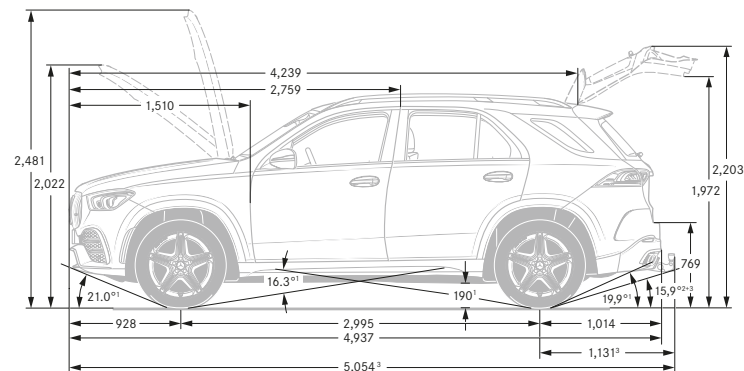
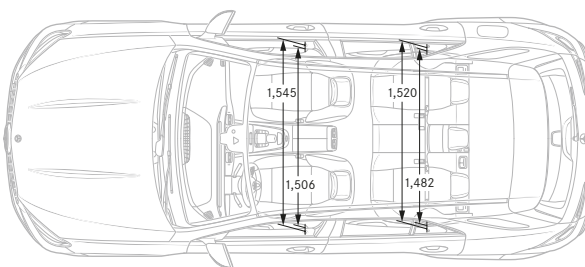
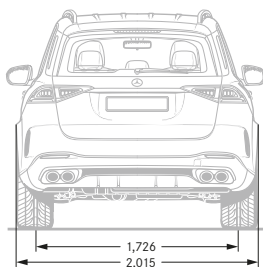
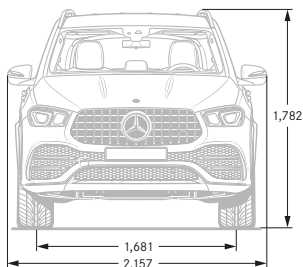

All measurements in millimetres. The dimensions shown are mean values and apply to standard-specification, unladen vehicles

Design	Technology	Plug-In Hybrid	Model lines	Upholstery	Model prices	Mercedes-AMG	Mercedes-AMG prices	Mercedes-AMG upholstery	Personalisation	Standard equipment	Genuine accessories	Technical data	Additional information
--------	------------	----------------	-------------	------------	--------------	--------------	---------------------	-------------------------	-----------------	--------------------	---------------------	----------------	------------------------



Book a test drive



Buy your GLE SUV



Find a Retailer

# Mercedes-AMG GLE 63 4MATIC+

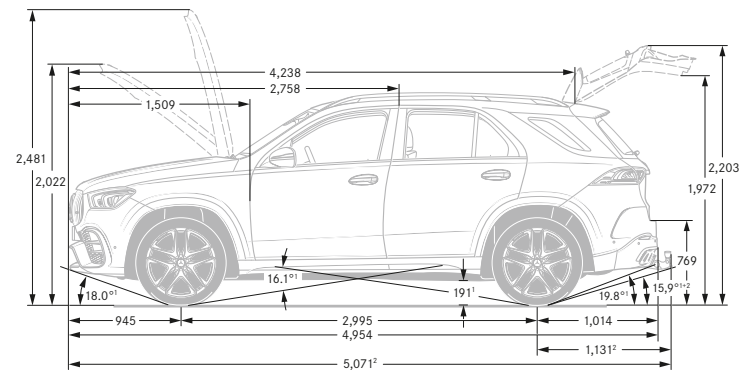
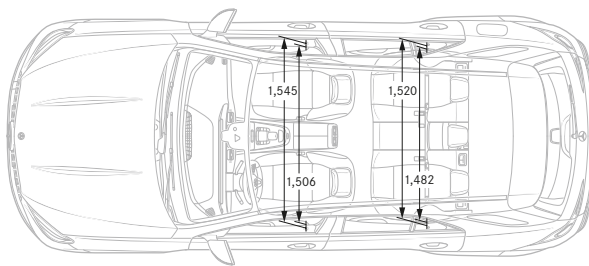
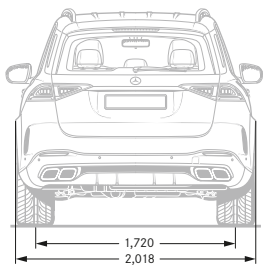
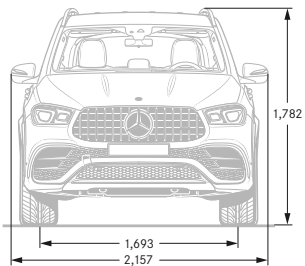

All measurements in millimetres. The dimensions shown are mean values and apply to standard-specification, unladen vehicles

Design	Technology	Plug-In Hybrid	Model lines	Upholstery	Model prices	Mercedes-AMG	Mercedes-AMG prices	Mercedes-AMG upholstery	Personalisation	Standard equipment	Genuine accessories	Technical data	Additional information
--------	------------	----------------	-------------	------------	--------------	--------------	---------------------	-------------------------	-----------------	--------------------	---------------------	----------------	------------------------



# Road Fund Licence

All road vehicle registrations are subject to Vehicle Excise Duty (Road Fund Licence), which varies in accordance with the vehicle's CO<sub>2</sub> emissions. A first year rate for each taxation band will apply. The table below shows the bands (A-M) created by the DVLA and the corresponding Road Fund Licence. CO<sub>2</sub> emissions and the relevant Excise Duty are shown on the model pricing pages.

Band	CO <sub>2</sub> emissions (g/km)	First year rate petrol and RDE2 diesel (£)	First year rate all other diesel (£) <sup>1</sup>	First year rate alternative fuel (£)	Electric vehicles		Alternative fuel vehicles		Petrol/diesel vehicles	
					Standard rate (£)	Premium rate (£) <sup>2</sup>	Standard rate (£)	Premium rate (£) <sup>2</sup>	Standard rate (£)	Premium rate (£) <sup>2</sup>
A	0	0.00	0.00	0.00	0.00	0.00	0.00	0.00	0.00	0.00
B	1 to 50	10.00	25.00	0.00	0.00	0.00	155.00	510.00	165.00	520.00
C	51 to 75	25.00	120.00	15.00	0.00	0.00	155.00	510.00	165.00	520.00
D	76 to 90	120.00	150.00	110.00	0.00	0.00	155.00	510.00	165.00	520.00
E	91 to 100	150.00	170.00	140.00	0.00	0.00	155.00	510.00	165.00	520.00
F	101 to 110	170.00	190.00	160.00	0.00	0.00	155.00	510.00	165.00	520.00
G	111 to 130	190.00	230.00	180.00	0.00	0.00	155.00	510.00	165.00	520.00
H	131 to 150	230.00	585.00	220.00	0.00	0.00	155.00	510.00	165.00	520.00
I	151 to 170	585.00	945.00	575.00	0.00	0.00	155.00	510.00	165.00	520.00
J	171 to 190	945.00	1,420.00	935.00	0.00	0.00	155.00	510.00	165.00	520.00
K	191 to 225	1,420.00	2,015.00	1,410.00	0.00	0.00	155.00	510.00	165.00	520.00
L	226 to 255	2,015.00	2,365.00	2,005.00	0.00	0.00	155.00	510.00	165.00	520.00
M	over 255	2,365.00	2,365.00	2,355.00	0.00	0.00	155.00	510.00	165.00	520.00



Some of the model features, optional extras and colours shown may not be available, or may only be available in a different specification, or at a different price.  
<sup>1</sup>Applies to all Mercedes-Benz diesel models which do not comply with RDE (Real Driving Emissions) Step 2 Certified (Euro 6d)  
<sup>2</sup>Premium rate only applicable to vehicles where the list price is over £40,000 including any factory-fitted options, standard UK delivery charge and VAT



# Services and insurance

## Mercedes-Benz ServiceCare

We believe that servicing costs should be as flexible and affordable as possible for your GLE, which is why we offer ServiceCare, an easy way to budget for all your servicing costs. It spreads your bills into manageable payments based on whether you have a new or used Mercedes-Benz.

With ServiceCare we guarantee the price of parts and labour for up to four services and safeguard against any further inflation. It also covers the cost of all recommended service items including brake fluid, spark plugs, air filters, fuel filters and screen wash.

You can choose either to add your servicing costs into your monthly spend or pay the full amount in a one-off payment, giving you peace of mind that they are taken care of for the period of the plan.

[Click here for more information](#)

## Warranty and breakdown cover

Every Mercedes-Benz comes with a three-year unlimited mileage warranty against manufacturing or material defects<sup>1</sup> and up to 30 years warranty against perforation due to corrosion from the inside out.<sup>2</sup> What's more, it's also covered by Mercedes-Benz Roadside Assistance – a unique package comprising up to 30 years pan-European breakdown assistance.<sup>2</sup>

## Motor Insurance

We know that once you have chosen your Mercedes-Benz you can't wait to drive it – that's why we created First Cover<sup>3</sup>. It gives you 7 days' free comprehensive Motor Insurance when you buy a new or used vehicle from a Mercedes-Benz Retailer. We will also send you a quote for annual cover, so you can enjoy the same peace of mind all year round.

[Apply for First Cover](#)



<sup>1</sup>Applies to vehicles sold by Mercedes-Benz in the UK to its franchised Retailers    <sup>2</sup>Subject to full Terms and Conditions, dependent on date of registration, available upon request  
<sup>3</sup>Terms and Conditions apply. We are an independent intermediary dealing with selected insurers in respect of annual insurance





Effective from September 2022 Production. Information correct at time of publication 05.07.2022  
Prices and specifications are subject to change without prior notice.  
MBV167PL/0722 MY803

