



The G-Class

Effective from May 2022 Production.

Mercedes-Benz





Book a test drive



Buy your G-Class



Find a Retailer



Some of the model features, optional extras and colours shown may not be available, or may only be available in a different specification.



Design	Technology	Model line	Model prices	Model line wheels, trims & uph.	Mercedes-AMG	Mercedes-AMG prices	Mercedes-AMG wheels, trims & uph.	Personalisation	Standard equipment	Genuine accessories	Technical data	Additional information
--------	------------	------------	--------------	---------------------------------	--------------	---------------------	-----------------------------------	-----------------	--------------------	---------------------	----------------	------------------------



Book a test drive



Buy your G-Class



Find a Retailer



Some of the model features, optional extras and colours shown may not be available, or may only be available in a different specification.

Design	Technology	Model line	Model prices	Model line wheels, trims & uph.	Mercedes-AMG	Mercedes-AMG prices	Mercedes-AMG wheels, trims & uph.	Personalisation	Standard equipment	Genuine accessories	Technical data	Additional information
--------	------------	------------	--------------	---------------------------------	--------------	---------------------	-----------------------------------	-----------------	--------------------	---------------------	----------------	------------------------



Book a test drive



Buy your G-Class



Find a Retailer



G-Class

Technology

Design	Technology	Model line	Model prices	Model line wheels, trims & uph.	Mercedes-AMG	Mercedes-AMG prices	Mercedes-AMG wheels, trims & uph.	Personalisation	Standard equipment	Genuine accessories	Technical data	Additional information
------------------------	----------------------------	----------------------------	------------------------------	---	------------------------------	-------------------------------------	---	---------------------------------	------------------------------------	-------------------------------------	--------------------------------	--



Book a test drive



Buy your G-Class



Find a Retailer

More is impossible

In off-road terrain the G-Class remains an unrivalled legend. It masters the key off-road disciplines effortlessly and with impressive results, e.g. gradeability, ground clearance, wading depth, angle of approach/departure and lateral slopes.



Front axle

It is executed as a double-wishbone axle with independent suspension and spring strut and ensures the necessary traction in even the most difficult off-road terrain. The new independent suspension enables more precise wheel location, thus in turn enabling better control of the G-Class.



Rear axle

Extremely robust rigid axle with high degree of axial twist supports the chassis and the body. The rigid axle is connected to the ladder frame by means of two lower and two upper trailing arms as well as a panhard rod, which prevents sideways movements in the suspension in terms of between the vehicle body and rigid rear axle, and ensures the necessary traction even in the most difficult terrain and based on the road surface.



Body

The ladder frame has formed the basis for the G-Class since the very beginning. The ladder frame consists of sheet steel of up to 3.4 mm in thickness with closed side members and cross members. This design is considerably more robust and better suited to off-road use than a self-supporting body.

Off-road performance

- Angle of approach/departure: 30.9°/29.9°
- Breakover angle: 25.7°
- Climbing ability: up to 100%
- Ground clearance: 24.1cm
- Maximum fording depth: 70 cm
- Side slope angle: up to 70%

Design	Technology	Model line	Model prices	Model line wheels, trims & uph.	Mercedes-AMG	Mercedes-AMG prices	Mercedes-AMG wheels, trims & uph.	Personalisation	Standard equipment	Genuine accessories	Technical data	Additional information
--------	------------	------------	--------------	---------------------------------	--------------	---------------------	-----------------------------------	-----------------	--------------------	---------------------	----------------	------------------------

Inside, luxury meets adventure

The G-Class combines timeless design with cutting-edge technology to create an atmosphere that is as relaxing as it is revolutionary.



Smartphone integration¹

Smartphone integration¹ merges the mobile phone with the infotainment system via Apple CarPlay® and Android Auto™. This gives you convenient access to the most important applications on your smartphone. You can also use apps from third-party service providers such as Spotify quickly and easily.

¹Compatible mobile phone required.



THERMOTRONIC automatic climate control

The THERMOTRONIC automatic climate control system with three climate zones and three climate styles provide an individual feel-good atmosphere on board. The driver and front passenger are able to set the temperature, air distribution and climate style to suit their personal needs. The third climate zone is in the rear - with separately adjustable temperature and airflow.



COMAND Online

Get to your destination faster and in more relaxed style with COMAND Online, the navigation system which is perfectly integrated into the cockpit. Thanks to Live Traffic Information and Car-to-X Communication, you can avoid traffic jams and be made aware of possible sources of danger even earlier, for example.

Design	Technology	Model line	Model prices	Model line wheels, trims & uph.	Mercedes-AMG	Mercedes-AMG prices	Mercedes-AMG wheels, trims & uph.	Personalisation	Standard equipment	Genuine accessories	Technical data	Additional information
--------	------------	------------	--------------	---------------------------------	--------------	---------------------	-----------------------------------	-----------------	--------------------	---------------------	----------------	------------------------



Book a test drive



Buy your G-Class



Find a Retailer

AMG Line Premium Plus



Expressive and strong.

The AMG Line Premium Plus convinces with its expressive styling inside and out, thanks to the 20" AMG alloy wheels, MULTIBEAM LED headlamps and the radiator grille with chrome trim elements. Inside you're greeted by EXCLUSIVE Line interior with seats upholstered in AMG Line Nappa leather.

AMG Line Premium Plus

OTR from £123,500¹

¹The recommended on-the-road price includes the Road Fund Licence applicable to the standard model plus delivery charge (£730.00 incl. VAT), new vehicle registration fee (£55.00), fuel (£50.00 incl. VAT), and number plates (£25.00 incl. VAT). VAT is calculated at the standard rate of 20%. Some of the model features, optional extras and colours shown may not be available, or may only be available in a different specification, or at a different price

Design	Technology	Model line	Model prices	Model line wheels, trims & uph.	Mercedes-AMG	Mercedes-AMG prices	Mercedes-AMG wheels, trims & uph.	Personalisation	Standard equipment	Genuine accessories	Technical data	Additional information
--------	------------	------------	--------------	---------------------------------	--------------	---------------------	-----------------------------------	-----------------	--------------------	---------------------	----------------	------------------------

G-Class AMG Line Premium Plus Standard equipment highlights



Option shown: G MANUFAKTUR paint



Option shown: G MANUFAKTUR paint

Exterior

20" AMG alloy wheels - 5-twin-spoke design, painted high-gloss black with a high-shine finish (code R16)

Brake calipers with 'Mercedes-Benz' lettering

Exterior protective strips in brushed aluminium look

Heat insulating dark tinted glass

Heated windscreen

MULTIBEAM LED

Parking package with 360° camera

Radiator grille with chrome trim elements

Side running boards

Sliding sunroof

Stainless-steel spare wheel cover

Summer tyres

Suspension with adaptive damping adjustment

Trailer coupling with ESP* trailer stabilisation



Design	Technology	Model line	Model prices	Model line wheels, trims & uph.	Mercedes-AMG	Mercedes-AMG prices	Mercedes-AMG wheels, trims & uph.	Personalisation	Standard equipment	Genuine accessories	Technical data	Additional information
--------	------------	------------	--------------	---------------------------------	--------------	---------------------	-----------------------------------	-----------------	--------------------	---------------------	----------------	------------------------



Communications, Safety and Assistance Systems

Burmester® surround sound system

COMAND Online system with 12.3-inch media display

DAB digital radio tuner

Driving Assistance package¹ consisting of Blind Spot Assist and Distance Assist DISTRONIC

Pre-installation for Rear Seat Entertainment System



Burmester® surround sound system

Interior

Ambient lighting – 64 colours

EXCLUSIVE Line interior

Multifunction sport-steering wheel in nappa leather

Roof lining – MANUFAKTUR black DINAMICA microfibre

Rubber mat for load compartment

Side airbags in the rear

Upper part of dashboard in Nappa leather

Widescreen cockpit

Trim and Upholstery

Trim – G MANUFAKTUR black flamed open-pore ash wood

Upholstery – AMG Line Nappa leather, black

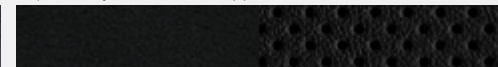
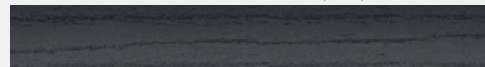

¹Our driver assistance and safety systems are aids and do not relieve you of your responsibility as the driver. Please take note of the information in the Owner's Manual and the system limits which are described therein

Design	Technology	Model line	Model prices	Model line wheels, trims & uph.	Mercedes-AMG	Mercedes-AMG prices	Mercedes-AMG wheels, trims & uph.	Personalisation	Standard equipment	Genuine accessories	Technical data	Additional information
--------	------------	------------	--------------	---------------------------------	--------------	---------------------	-----------------------------------	-----------------	--------------------	---------------------	----------------	------------------------

[Book a test drive](#)[Buy your G-Class](#)[Find a Retailer](#)

Model prices

Model line	Engine	Transmission	CO ₂ WLTP ^{1,*}	Basic RRP excl. VAT (£)	Total RRP incl. VAT (£)	Road Fund Licence (£) ² WLTP	Rec. OTR price (£) ³ WLTP	P11D value (£)	BiK tax rate 2022/23 (%) ²
AMG Line Premium Plus									
G400 d	Diesel – 2,925 cc, 6-cylinder, 330 hp/243 kW	9G-TRONIC automatic	289	100,229.17	120,275.00	2,365.00	123,500.00	121,080.00	37

¹The indicated values were determined according to the prescribed measurement method - Worldwide Harmonised Light Vehicle Test Procedure (WLTP). Figures shown may include options which are not available in the UK. ²Figures shown are for comparability purposes; only compare with other cars tested to the same technical procedures. Figures may not reflect real life driving results, which will depend upon a number of factors including factory-fitted options, accessories fitted (post registration), variations in weather, driving styles and vehicle load. Further information about the test used to establish fuel consumption and CO₂ figures can be found at <http://www.mercedes-benz.co.uk/WLTP> ³A different first year rate of Vehicle Excise Duty (Road Fund Licence) applies for new cars. Please refer to page 55 for the relevant rate for the second and subsequent years ³The recommended on-the-road price includes the Road Fund Licence applicable to the standard model plus delivery charge (£730.00 incl. VAT), new vehicle registration fee (£55.00), fuel (£50.00 incl. VAT), and number plates (£25.00 incl. VAT). VAT is calculated at the standard rate of 20%. Some of the model features, optional extras and colours shown may not be available, or may only be available in a different specification, or at a different price

Design	Technology	Model line	Model prices	Model line wheels, trims & uph.	Mercedes-AMG	Mercedes-AMG prices	Mercedes-AMG wheels, trims & uph.	Personalisation	Standard equipment	Genuine accessories	Technical data	Additional information
--------	------------	------------	--------------	---------------------------------	--------------	---------------------	-----------------------------------	-----------------	--------------------	---------------------	----------------	------------------------



Book a test drive



Buy your G-Class



Find a Retailer

Wheels

- Standard
- No-cost option



R16 20" AMG alloy wheels - 5-twin-spoke design, painted high-gloss black with a high-shine finish, 275/50 R20 tyres

AMG Line Premium Plus



R17 20" AMG alloy wheels - 5-twin-spoke design, painted himalayas grey with a high-shine finish, 275/50 R20 tyres

AMG Line Premium Plus



Design	Technology	Model line	Model prices	Model line wheels, trims & uph.	Mercedes-AMG	Mercedes-AMG prices	Mercedes-AMG wheels, trims & uph.	Personalisation	Standard equipment	Genuine accessories	Technical data	Additional information
--------	------------	------------	--------------	---------------------------------	--------------	---------------------	-----------------------------------	-----------------	--------------------	---------------------	----------------	------------------------



Book a test drive



Buy your G-Class



Find a Retailer

Trims

- Standard
- No-cost option



VA1 G MANUFAKTUR black flamed open-pore ash wood

AMG Line Premium Plus



VA2 Open-pore natural walnut wood

AMG Line Premium Plus



ZG2 MANUFAKTUR black piano lacquer

AMG Line Premium Plus



Design	Technology	Model line	Model prices	Model line wheels, trims & uph.	Mercedes-AMG	Mercedes-AMG prices	Mercedes-AMG wheels, trims & uph.	Personalisation	Standard equipment	Genuine accessories	Technical data	Additional information
--------	------------	------------	--------------	---------------------------------	--------------	---------------------	-----------------------------------	-----------------	--------------------	---------------------	----------------	------------------------

Upholstery

● Standard □ No-cost option - Not available



501A* nappa leather¹ - black²

AMG Line Premium Plus	●
Total RRP incl. VAT	-



545A nappa leather¹ - nut brown/black²

AMG Line Premium Plus	□
Total RRP incl. VAT	-



575A nappa leather¹ - macchiato beige/black

AMG Line Premium Plus	□
Total RRP incl. VAT	-



537A nappa leather¹ - classic red/black

AMG Line Premium Plus	□
Total RRP incl. VAT	-

*Available with MANUFATUR seat belts in red

¹At least 80% of the seat upholstery is pure leather, while up to 20% may consist of man-made leather

²Not available with rubellite red paint (code 660)

Please refer to page 32 for G MANUFATUR upholstery series (code P76)

Design	Technology	Model line	Model prices	Model line wheels, trims & uph.	Mercedes-AMG	Mercedes-AMG prices	Mercedes-AMG wheels, trims & uph.	Personalisation	Standard equipment	Genuine accessories	Technical data	Additional information
--------	------------	------------	--------------	---------------------------------	--------------	---------------------	-----------------------------------	-----------------	--------------------	---------------------	----------------	------------------------



Book a test drive



Buy your G-Class



Find a Retailer



AMG



G-Class

Mercedes-AMG

Design	Technology	Model line	Model prices	Model line wheels, trims & uph.	Mercedes-AMG	Mercedes-AMG prices	Mercedes-AMG wheels, trims & uph.	Personalisation	Standard equipment	Genuine accessories	Technical data	Additional information
--------	------------	------------	--------------	---------------------------------	--------------	---------------------	-----------------------------------	-----------------	--------------------	---------------------	----------------	------------------------



Book a test drive



Buy your G-Class



Find a Retailer

Mercedes-AMG G-Class Model lines overview



Mercedes-AMG G 63 »



Mercedes-AMG G 63 Magno Edition »



Mercedes-AMG G 63 Carbon Edition »

Design	Technology	Model line	Model prices	Model line wheels, trims & uph.	Mercedes-AMG	Mercedes-AMG prices	Mercedes-AMG wheels, trims & uph.	Personalisation	Standard equipment	Genuine accessories	Technical data	Additional information
--------	------------	------------	--------------	---------------------------------	--------------	---------------------	-----------------------------------	-----------------	--------------------	---------------------	----------------	------------------------

Mercedes-AMG G 63 Standard equipment highlights



Option shown: periclae green metallic (code 300)



Option shown: periclae green metallic (code 300)

Engine, Transmission and Suspension

AMG RIDE CONTROL suspension with DYNAMIC SELECT

AMG SPEEDSHIFT TCT 9G

Exterior

22" AMG forged wheels – cross-spoke design, painted matt black with a high-sheen rim flange (code RG4)

AMG red brake callipers

AMG-specific radiator grille

AMG performance sports exhaust system with chrome-trimmed twin tailpipes

Exterior protective strip with trim insert in black with AMG logo, silver-coloured

Electric sunroof – sliding, with one-touch opening

Heated windscreen

Metallic paint

MULTIBEAM LED headlamps with Adaptive Highbeam Assist Plus

Privacy glass

Parking package with 360° camera

Side running boards

Stainless steel package

Stainless steel spare wheel cover

Summer tyres

Trailer coupling with ball-type head

Underguard



OTR from **£164,550¹**

¹The recommended on-the-road price includes the Road Fund Licence applicable to the standard model plus delivery charge (£730.00 incl. VAT), new vehicle registration fee (£55.00), fuel (£50.00 incl. VAT), and number plates (£25.00 incl. VAT). VAT is calculated at the standard rate of 20%. Some of the model features, optional extras and colours shown may not be available, or may only be available in a different specification, or at a different price

Design	Technology	Model line	Model prices	Model line wheels, trims & uph.	Mercedes-AMG	Mercedes-AMG prices	Mercedes-AMG wheels, trims & uph.	Personalisation	Standard equipment	Genuine accessories	Technical data	Additional information
--------	------------	------------	--------------	---------------------------------	--------------	---------------------	-----------------------------------	-----------------	--------------------	---------------------	----------------	------------------------



No-cost option shown: Exclusive Nappa leather platinum white/black (code 953A + P76)

Interior

Active Multicontour Seat package	DINAMICA roof liner
Ambient lighting - choice of 64 colour settings	ENERGIZING comfort control
AMG floor mats with 'AMG' lettering	Illuminated AMG door sill panels with 'AMG' lettering at front and rear
AMG Performance steering wheel in Nappa leather	Ionisation of interior air
AMG-specific IWC-design analogue clock	Multifunction steering wheel - heated
AMG sports seats in AMG Nappa leather	
Dashboard - leather trimmed	

Communications, Safety and Assistance Systems

AMG dual bonded widescreen cockpit displays (12.3-inch)	Driving Assistance package ¹
Burmester® surround sound system	Smartphone integration ² including Apple CarPlay® and Android Auto™
COMAND Online system with 12.3-inch media display	
DAB digital radio tuner	



No-cost option shown: Exclusive Nappa leather platinum white/black (code 953A + P76)

Trim and Upholstery

Trim - G MANUFAKTUR black piano lacquer	Upholstery - AMG Nappa leather, black
---	---------------------------------------

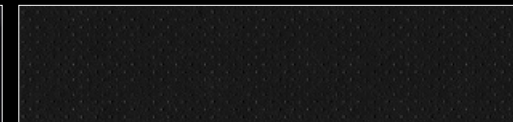
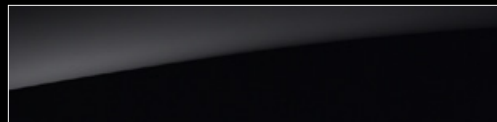

¹Our driver assistance and safety systems are aids and do not relieve you of your responsibility as the driver. Please take note of the information in the Owner's Manual and the system limits which are described therein ²Compatible mobile phone required

Design	Technology	Model line	Model prices	Model line wheels, trims & uph.	Mercedes-AMG	Mercedes-AMG prices	Mercedes-AMG wheels, trims & uph.	Personalisation	Standard equipment	Genuine accessories	Technical data	Additional information
--------	------------	------------	--------------	---------------------------------	--------------	---------------------	-----------------------------------	-----------------	--------------------	---------------------	----------------	------------------------

Mercedes-AMG G 63 Carbon Edition Standard equipment highlights



Option shown: opalite white bright (code 885)



Option shown: opalite white bright (code 885)

OTR from **£171,050¹**

In addition to/replacement of Mercedes-AMG G 63:

Exterior

22" AMG forged wheels – cross-spoke design, painted matt black with a high-sheen rim flange (code RG4)

AMG Night package

Summer tyres



¹The recommended on-the-road price includes the Road Fund Licence applicable to the standard model plus delivery charge (£730.00 incl. VAT), new vehicle registration fee (£55.00), fuel (£50.00 incl. VAT), and number plates (£25.00 incl. VAT). VAT is calculated at the standard rate of 20%. Some of the model features, optional extras and colours shown may not be available, or may only be available in a different specification, or at a different price

Design	Technology	Model line	Model prices	Model line wheels, trims & uph.	Mercedes-AMG	Mercedes-AMG prices	Mercedes-AMG wheels, trims & uph.	Personalisation	Standard equipment	Genuine accessories	Technical data	Additional information
--------	------------	------------	--------------	---------------------------------	--------------	---------------------	-----------------------------------	-----------------	--------------------	---------------------	----------------	------------------------

AMG Performance steering wheel in carbon-fibre design/DINAMICA microfibre



Interior

AMG carbon-fibre trim elements

AMG Performance steering wheel in carbon-fibre design/
DINAMICA microfibre

Trim and Upholstery

Trim - AMG carbon fibre

Upholstery - AMG Nappa leather, black

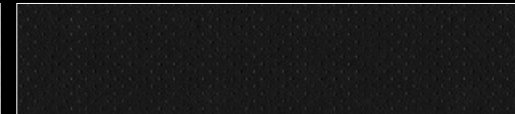

Design	Technology	Model line	Model prices	Model line wheels, trims & uph.	Mercedes-AMG	Mercedes-AMG prices	Mercedes-AMG wheels, trims & uph.	Personalisation	Standard equipment	Genuine accessories	Technical data	Additional information
--------	------------	------------	--------------	---------------------------------	--------------	---------------------	-----------------------------------	-----------------	--------------------	---------------------	----------------	------------------------

Mercedes-AMG G 63 Magno Edition Standard equipment highlights



In addition to/replacement of Mercedes-AMG G 63 Carbon Edition:

Exterior

22" AMG forged wheels – cross-spoke design, painted matt black with a high-sheen rim flange (code RG4)

AMG Night package II, including typography & Mercedes star at front and rear, in high-gloss black

AMG Night package magno

Brush guard in night black magno

G MANUFAKTUR bumpers and wheel arch flaring in night black magno

G MANUFAKTUR spare wheel ring painted in night black magno

Summer tyres



OTR from **£182,200¹**

¹The recommended on-the-road price includes the Road Fund Licence applicable to the standard model plus delivery charge (£730.00 incl. VAT), new vehicle registration fee (£55.00), fuel (£50.00 incl. VAT), and number plates (£25.00 incl. VAT). VAT is calculated at the standard rate of 20%. Some of the model features, optional extras and colours shown may not be available, or may only be available in a different specification, or at a different price

Design	Technology	Model line	Model prices	Model line wheels, trims & uph.	Mercedes-AMG	Mercedes-AMG prices	Mercedes-AMG wheels, trims & uph.	Personalisation	Standard equipment	Genuine accessories	Technical data	Additional information
--------	------------	------------	--------------	---------------------------------	--------------	---------------------	-----------------------------------	-----------------	--------------------	---------------------	----------------	------------------------



No-cost option shown: G MANUFAKTUR titanium grey pearl/black (code 958A + P77)



Trim and Upholstery

Trim – AMG carbon fibre

Upholstery – AMG Exclusive Nappa leather, black

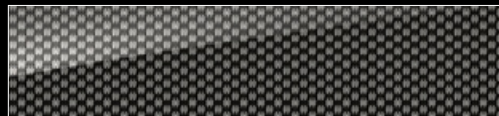

Interior

Active Multicontour Seat package Plus

SUPERIOR Line interior

Dashboard in nappa leather

Design	Technology	Model line	Model prices	Model line wheels, trims & uph.	Mercedes-AMG	Mercedes-AMG prices	Mercedes-AMG wheels, trims & uph.	Personalisation	Standard equipment	Genuine accessories	Technical data	Additional information
--------	------------	------------	--------------	---------------------------------	--------------	---------------------	-----------------------------------	-----------------	--------------------	---------------------	----------------	------------------------

[Book a test drive](#)[Buy your G-Class](#)[Find a Retailer](#)

Become the AMG expert

Unleash a new level of performance.



Step into the world of performance and experience the AMG brand at Mercedes-Benz World – from the powerful sound of the engines to the smell of the leather to the unmistakable design of our vehicles.

Mercedes-Benz World invites all Mercedes-AMG customers to a complimentary adrenaline-packed driving experience. Feel the sensational AMG driving performance, develop your driving skills and even try your hand at power-sliding on the Wet Skid Circle. With expert one-to-one guidance from a Driving Specialist in the passenger seat, experience every inch of our Handling Circuits, Dynamic Straight and low friction surfaces.

[Click here for more information](#)



TERMS AND CONDITIONS

The following customers only are eligible: The first purchaser/registered keeper of a newly registered Mercedes-AMG. The complimentary Training must be booked and taken within 12 months of delivery of your Mercedes-AMG, the Training is offered on specific days only and subject to availability. Upgrades are available for an additional cost, details upon request. Transferable to individuals who reside at the same postal address only. Mercedes-Benz Cars UK Limited reserves the right to amend or withdraw this Training experience. Attendees must hold a full UK driving licence. Attendees will be required to sign the Mercedes-Benz World Driving Risk Acknowledgement prior to undertaking the Training experience. The Training experience is also subject to the Mercedes-Benz World Terms and Conditions, as applicable. Invitation is emailed to the customer post-delivery, permission via the customer contact preferences must be given to enable Mercedes-Benz World to contact. Retailer demonstrator vehicles are not eligible.

Design	Technology	Model line	Model prices	Model line wheels, trims & uph.	Mercedes-AMG	Mercedes-AMG prices	Mercedes-AMG wheels, trims & uph.	Personalisation	Standard equipment	Genuine accessories	Technical data	Additional information
--------	------------	------------	--------------	---------------------------------	--------------	---------------------	-----------------------------------	-----------------	--------------------	---------------------	----------------	------------------------

[Book a test drive](#)[Buy your G-Class](#)[Find a Retailer](#)

Mercedes-AMG prices



Model line	Engine	Transmission	CO ₂ WLTP ^{1,*}	Basic RRP excl. VAT (£)	Total RRP incl. VAT (£)	Road Fund Licence (£) ² WLTP	Rec. OTR price (£) ³ WLTP	P11D value (£)	BiK tax rate 2022/23 (%) ²
Mercedes-AMG									
Mercedes-AMG G 63 4MATIC	Petrol – 3,982cc, 8-cylinder, 585 hp/430 kW	AMG SPEEDSHIFT PLUS 9G-TRONIC	363	134,437.50	161,325.00	2,365.00	164,550.00	162,130.00	37
Mercedes-AMG Carbon Edition									
Mercedes-AMG G 63 4MATIC	Petrol – 3,982cc, 8-cylinder, 585 hp/430 kW	AMG SPEEDSHIFT PLUS 9G-TRONIC	363	139,854.17	167,825.00	2,365.00	171,050.00	168,630.00	37
Mercedes-AMG Magno Edition									
Mercedes-AMG G 63 4MATIC	Petrol – 3,982cc, 8-cylinder, 585 hp/430 kW	AMG SPEEDSHIFT PLUS 9G-TRONIC	363	149,145.83	178,975.00	2,365.00	182,200.00	179,780.00	37

¹The indicated values were determined according to the prescribed measurement method - Worldwide Harmonised Light Vehicle Test Procedure (WLTP). Figures shown may include options which are not available in the UK. ²Figures shown are for comparability purposes; only compare with other cars tested to the same technical procedures. Figures may not reflect real life driving results, which will depend upon a number of factors including factory-fitted options, accessories fitted (post registration), variations in weather, driving styles and vehicle load. Further information about the test used to establish fuel consumption and CO₂ figures can be found at <http://www.mercedes-benz.co.uk/WLTP> ³A different first year rate of Vehicle Excise Duty (Road Fund Licence) applies for new cars. Please refer to page 55 for the relevant rate for the second and subsequent years ⁴The recommended on-the-road price includes the Road Fund Licence applicable to the standard model plus delivery charge (£730.00 incl. VAT), new vehicle registration fee (£55.00), fuel (£50.00 incl. VAT), and number plates (£25.00 incl. VAT). VAT is calculated at the standard rate of 20%. Some of the model features, optional extras and colours shown may not be available, or may only be available in a different specification, or at a different price

Design	Technology	Model line	Model prices	Model line wheels, trims & uph.	Mercedes-AMG	Mercedes-AMG prices	Mercedes-AMG wheels, trims & uph.	Personalisation	Standard equipment	Genuine accessories	Technical data	Additional information
--------	------------	------------	--------------	---------------------------------	--------------	---------------------	-----------------------------------	-----------------	--------------------	---------------------	----------------	------------------------



Book a test drive



Buy your G-Class



Find a Retailer

Mercedes-AMG wheels



- Standard
- No-cost option



RG4 22" AMG forged wheels - cross-spoke design, painted matt black with a high-shine rim flange, 295/40 R22 tyres

- Mercedes-AMG G 63
- Mercedes-AMG G 63 Carbon Edition
- Mercedes-AMG G 63 Magno Edition



RG5 22" AMG forged wheels - cross-spoke design, painted titanium grey with a high-shine finish, 295/40 R22 tyres

- Mercedes-AMG G 63
- Mercedes-AMG G 63 Carbon Edition
- Mercedes-AMG G 63 Magno Edition

Design	Technology	Model line	Model prices	Model line wheels, trims & uph.	Mercedes-AMG	Mercedes-AMG prices	Mercedes-AMG wheels, trims & uph.	Personalisation	Standard equipment	Genuine accessories	Technical data	Additional information
--------	------------	------------	--------------	---------------------------------	--------------	---------------------	-----------------------------------	-----------------	--------------------	---------------------	----------------	------------------------

[Book a test drive](#)[Buy your G-Class](#)[Find a Retailer](#)

Mercedes-AMG trims

● Standard □ No-cost option — Not available



ZG2 G MANUFAKTUR black piano lacquer

Mercedes-AMG G 63	●
Mercedes-AMG G 63 Carbon Edition	—
Mercedes-AMG G 63 Magno Edition	—



ZG6 AMG carbon fibre

Mercedes-AMG G 63	—
Mercedes-AMG G 63 Carbon Edition	●
Mercedes-AMG G 63 Magno Edition	●



VA2 Open-pore natural walnut wood trim

Mercedes-AMG G 63	□
Mercedes-AMG G 63 Carbon Edition	—
Mercedes-AMG G 63 Magno Edition	—

Design	Technology	Model line	Model prices	Model line wheels, trims & uph.	Mercedes-AMG	Mercedes-AMG prices	Mercedes-AMG wheels, trims & uph.	Personalisation	Standard equipment	Genuine accessories	Technical data	Additional information
--------	------------	------------	--------------	---------------------------------	--------------	---------------------	-----------------------------------	-----------------	--------------------	---------------------	----------------	------------------------



Mercedes-AMG upholstery

● Standard □ No-cost option – Not available



501A* AMG nappa leather¹ - black

Mercedes-AMG G 63	●
Mercedes-AMG G 63 Carbon Edition	●
Mercedes-AMG G 63 Magno Edition	□



537A AMG nappa leather¹ - classic red/black

Mercedes-AMG G 63	●
Mercedes-AMG G 63 Carbon Edition	●
Mercedes-AMG G 63 Magno Edition	□



525A AMG nappa leather¹ - truffle brown/black

Mercedes-AMG G 63	●
Mercedes-AMG G 63 Carbon Edition	●
Mercedes-AMG G 63 Magno Edition	□



535A AMG nappa leather¹ - macchiato beige/black

Mercedes-AMG G 63	●
Mercedes-AMG G 63 Carbon Edition	●
Mercedes-AMG G 63 Magno Edition	□



801A AMG Exclusive Nappa leather¹ - black

Mercedes-AMG G 63	□
Mercedes-AMG G 63 Carbon Edition ²	□
Mercedes-AMG G 63 Magno Edition	●

*Available with MANUFATUR seat belts in red ¹100% of upholstery is pure leather ²Only in conjunction with G MANUFATUR package (code DPM)

Design	Technology	Model line	Model prices	Model line wheels, trims & uph.	Mercedes-AMG	Mercedes-AMG prices	Mercedes-AMG wheels, trims & uph.	Personalisation	Standard equipment	Genuine accessories	Technical data	Additional information
--------	------------	------------	--------------	---------------------------------	--------------	---------------------	-----------------------------------	-----------------	--------------------	---------------------	----------------	------------------------

[Book a test drive](#)[Buy your G-Class](#)[Find a Retailer](#)

Colour options Non-metallic and metallic paints

● Standard □ No-cost option – Not available



149 polar white non-metallic	
AMG Line Premium Plus	●
Mercedes-AMG G63	□
Mercedes-AMG G63 Carbon Edition	□
Mercedes-AMG G63 Magno Edition	–



660 rubellite red metallic ¹	
AMG Line Premium Plus	□
Mercedes-AMG G63	□
Mercedes-AMG G63 Carbon Edition	□
Mercedes-AMG G63 Magno Edition	–



890 cavansite blue metallic	
AMG Line Premium Plus	□
Mercedes-AMG G63	□
Mercedes-AMG G63 Carbon Edition	□
Mercedes-AMG G63 Magno Edition	–



989 emerald green metallic	
AMG Line Premium Plus	□
Mercedes-AMG G63	□
Mercedes-AMG G63 Carbon Edition	□
Mercedes-AMG G63 Magno Edition	–



197 obsidian black metallic	
AMG Line Premium Plus	□
Mercedes-AMG G63	□
Mercedes-AMG G63 Carbon Edition	□
Mercedes-AMG G63 Magno Edition	–



775 iridium silver metallic	
AMG Line Premium Plus	□
Mercedes-AMG G63	●
Mercedes-AMG G63 Carbon Edition	●
Mercedes-AMG G63 Magno Edition	–



896 brilliant blue metallic	
AMG Line Premium Plus	□
Mercedes-AMG G63	□
Mercedes-AMG G63 Carbon Edition	□
Mercedes-AMG G63 Magno Edition	–



992 selenite grey metallic	
AMG Line Premium Plus	□
Mercedes-AMG G63	□
Mercedes-AMG G63 Carbon Edition	□
Mercedes-AMG G63 Magno Edition	–

¹Not available with leather nut brown/black (code 214A) Please note that, owing to limitations of on-screen representation, paint colours may differ from those shown

[Book a test drive](#)[Buy your G-Class](#)[Find a Retailer](#)

Colour options G MANUFAKTUR paints

○ Optional – Not available



026 sea blue metallic

AMG Line Premium Plus	○
Mercedes-AMG G63	○
Mercedes-AMG G63 Carbon Edition	○
Mercedes-AMG G63 Magno Edition	–
Total RRP incl. VAT	£4,000



041 graphite metallic

AMG Line Premium Plus	○
Mercedes-AMG G63	○
Mercedes-AMG G63 Carbon Edition	○
Mercedes-AMG G63 Magno Edition	–
Total RRP incl. VAT	£4,000



124 classic grey solid

AMG Line Premium Plus	○
Mercedes-AMG G63	○
Mercedes-AMG G63 Carbon Edition	○
Mercedes-AMG G63 Magno Edition	–
Total RRP incl. VAT	£4,000



255 olive metallic

AMG Line Premium Plus	○
Mercedes-AMG G63	○
Mercedes-AMG G63 Carbon Edition	○
Mercedes-AMG G63 Magno Edition	–
Total RRP incl. VAT	£4,000



464 desert sand non-metallic

AMG Line Premium Plus	○
Mercedes-AMG G63	○
Mercedes-AMG G63 Carbon Edition	○
Mercedes-AMG G63 Magno Edition	–
Total RRP incl. VAT	£4,000



032 mystic blue bright

AMG Line Premium Plus	○
Mercedes-AMG G63	○
Mercedes-AMG G63 Carbon Edition	○
Mercedes-AMG G63 Magno Edition	–
Total RRP incl. VAT	£4,000



046 platinum black metallic¹

AMG Line Premium Plus	○
Mercedes-AMG G63	○
Mercedes-AMG G63 Carbon Edition	–
Mercedes-AMG G63 Magno Edition	–
Total RRP incl. VAT	£4,000



162 south seas blue metallic

AMG Line Premium Plus	○
Mercedes-AMG G63	○
Mercedes-AMG G63 Carbon Edition	○
Mercedes-AMG G63 Magno Edition	–
Total RRP incl. VAT	£4,000



300 periclae green metallic

AMG Line Premium Plus	○
Mercedes-AMG G63	○
Mercedes-AMG G63 Carbon Edition	○
Mercedes-AMG G63 Magno Edition	–
Total RRP incl. VAT	£4,000



693 travertine beige metallic

AMG Line Premium Plus	○
Mercedes-AMG G63	○
Mercedes-AMG G63 Carbon Edition	○
Mercedes-AMG G63 Magno Edition	–
Total RRP incl. VAT	£4,000

¹Not available with Night package Please note that, owing to limitations of on-screen representation, paint colours may differ from those shown

Design	Technology	Model line	Model prices	Model line wheels, trims & uph.	Mercedes-AMG	Mercedes-AMG prices	Mercedes-AMG wheels, trims & uph.	Personalisation	Standard equipment	Genuine accessories	Technical data	Additional information
--------	------------	------------	--------------	---------------------------------	--------------	---------------------	-----------------------------------	-----------------	--------------------	---------------------	----------------	------------------------

[Book a test drive](#)[Buy your G-Class](#)[Find a Retailer](#)

Colour options G MANUFAKTUR paints

○ Optional – Not available



825 deep green non-metallic

AMG Line Premium Plus	○
Mercedes-AMG G63	○
Mercedes-AMG G63 Carbon Edition	○
Mercedes-AMG G63 Magno Edition	–

Total RRP incl. VAT £4,000



934 vintage blue non-metallic

AMG Line Premium Plus	○
Mercedes-AMG G63	○
Mercedes-AMG G63 Carbon Edition	○
Mercedes-AMG G63 Magno Edition	–

Total RRP incl. VAT £4,000



996 hyacinth red metallic

AMG Line Premium Plus	○
Mercedes-AMG G63	○
Mercedes-AMG G63 Carbon Edition	○
Mercedes-AMG G63 Magno Edition	–

Total RRP incl. VAT £4,000



885 opalite white bright

AMG Line Premium Plus	○
Mercedes-AMG G63	○
Mercedes-AMG G63 Carbon Edition	○
Mercedes-AMG G63 Magno Edition	–

Total RRP incl. VAT £4,000



963 indium grey metallic

AMG Line Premium Plus	○
Mercedes-AMG G63	○
Mercedes-AMG G63 Carbon Edition	○
Mercedes-AMG G63 Magno Edition	–

Total RRP incl. VAT £4,000

Please note that, owing to limitations of on-screen representation, paint colours may differ from those shown

Design	Technology	Model line	Model prices	Model line wheels, trims & uph.	Mercedes-AMG	Mercedes-AMG prices	Mercedes-AMG wheels, trims & uph.	Personalisation	Standard equipment	Genuine accessories	Technical data	Additional information
--------	------------	------------	--------------	---------------------------------	--------------	---------------------	-----------------------------------	-----------------	--------------------	---------------------	----------------	------------------------

[Book a test drive](#)[Buy your G-Class](#)[Find a Retailer](#)

Colour options G MANUFAKTUR magno paints

● Standard □ No-cost option ○ Optional – Not available



051 platinum magno	
AMG Line Premium Plus	○
Mercedes-AMG G 63	○
Mercedes-AMG G 63 Carbon Edition	○
Mercedes-AMG G 63 Magno Edition	□
Total RRP incl. VAT	£4,750



056 night black magno	
AMG Line Premium Plus	○
Mercedes-AMG G 63	○
Mercedes-AMG G 63 Carbon Edition	○
Mercedes-AMG G 63 Magno Edition	□
Total RRP incl. VAT	£4,750



271 citrine brown magno	
AMG Line Premium Plus	○
Mercedes-AMG G 63	○
Mercedes-AMG G 63 Carbon Edition	○
Mercedes-AMG G 63 Magno Edition	□
Total RRP incl. VAT	£4,750



658 san josé orange magno	
AMG Line Premium Plus	–
Mercedes-AMG G 63	○
Mercedes-AMG G 63 Carbon Edition	○
Mercedes-AMG G 63 Magno Edition	□
Total RRP incl. VAT	£4,750



677 kalahari gold magno	
AMG Line Premium Plus	○
Mercedes-AMG G 63	○
Mercedes-AMG G 63 Carbon Edition	○
Mercedes-AMG G 63 Magno Edition	□
Total RRP incl. VAT	£4,750



054 monza grey magno	
AMG Line Premium Plus	○
Mercedes-AMG G 63	○
Mercedes-AMG G 63 Carbon Edition	○
Mercedes-AMG G 63 Magno Edition	●
Total RRP incl. VAT	£4,750



164 dark olive magno	
AMG Line Premium Plus	○
Mercedes-AMG G 63	○
Mercedes-AMG G 63 Carbon Edition	○
Mercedes-AMG G 63 Magno Edition	□
Total RRP incl. VAT	£4,750



376 green hell magno	
AMG Line Premium Plus	–
Mercedes-AMG G 63	○
Mercedes-AMG G 63 Carbon Edition	○
Mercedes-AMG G 63 Magno Edition	□
Total RRP incl. VAT	£4,750



659 opalite white magno exclusive	
AMG Line Premium Plus	–
Mercedes-AMG G 63	○
Mercedes-AMG G 63 Carbon Edition	○
Mercedes-AMG G 63 Magno Edition	□
Total RRP incl. VAT	£4,750



795 manganite grey magno	
AMG Line Premium Plus	○
Mercedes-AMG G 63	○
Mercedes-AMG G 63 Carbon Edition	○
Mercedes-AMG G 63 Magno Edition	□
Total RRP incl. VAT	£4,750

Please note that, owing to limitations of on-screen representation, paint colours may differ from those shown

Design	Technology	Model line	Model prices	Model line wheels, trims & uph.	Mercedes-AMG	Mercedes-AMG prices	Mercedes-AMG wheels, trims & uph.	Personalisation	Standard equipment	Genuine accessories	Technical data	Additional information
--------	------------	------------	--------------	---------------------------------	--------------	---------------------	-----------------------------------	-----------------	--------------------	---------------------	----------------	------------------------



G manufaktur

G-Class

G MANUFAKTUR upholstery and package



Book a test drive



Buy your G-Class



Find a Retailer

G MANUFAKTUR upholsteryes No-cost options (AMG Line Premium Plus)



907A+P76 Nappa leather black with red topstitching



902A+P76 Nappa leather black with yacht blue topstitching



903A+P76 Nappa leather black with white topstitching



953A+P76 Nappa leather platinum white/black



958A+P76 Nappa leather titanium grey/black



909A+P76 Nappa leather black with gold topstitching



957A+P76 Nappa leather bengal red/black



964A+P76 Nappa leather saddle brown/black

Design	Technology	Model line	Model prices	Model line wheels, trims & uph.	Mercedes-AMG	Mercedes-AMG prices	Mercedes-AMG wheels, trims & uph.	Personalisation	Standard equipment	Genuine accessories	Technical data	Additional information
--------	------------	------------	--------------	---------------------------------	--------------	---------------------	-----------------------------------	-----------------	--------------------	---------------------	----------------	------------------------



Book a test drive



Buy your G-Class



Find a Retailer

G MANUFAKTUR upholsteryes No-cost options (Mercedes-AMG G 63)



907A+P76 Nappa leather black with red topstitching



902A+P76 Nappa leather black with yacht blue topstitching



903A+P76 Nappa leather black with white topstitching



953A+P76 Nappa leather platinum white/black



924A+P76 Nappa leather espresso brown



909A+P76 Nappa leather black with gold topstitching



958A+P76 Nappa leather titanium grey/black



957A+P76 Nappa leather bengal red/black



922A+P76 Nappa leather yacht blue



964A+P76 Nappa leather saddle brown/black

Design	Technology	Model line	Model prices	Model line wheels, trims & uph.	Mercedes-AMG	Mercedes-AMG prices	Mercedes-AMG wheels, trims & uph.	Personalisation	Standard equipment	Genuine accessories	Technical data	Additional information
--------	------------	------------	--------------	---------------------------------	--------------	---------------------	-----------------------------------	-----------------	--------------------	---------------------	----------------	------------------------



Book a test drive



Buy your G-Class



Find a Retailer

G MANUFAKTUR upholsteryes No-cost options (Mercedes-AMG G 63)



928A+P76 Nappa leather titanium grey pearl



934A+P76 Nappa leather saddle brown



917A+P76 Nappa leather black with bengal red A-band



923A+P76 Nappa leather platinum white/black



927A+P76 Nappa leather bengal red



916A+P76 Nappa leather black with lime green A-band

Design	Technology	Model line	Model prices	Model line wheels, trims & uph.	Mercedes-AMG	Mercedes-AMG prices	Mercedes-AMG wheels, trims & uph.	Personalisation	Standard equipment	Genuine accessories	Technical data	Additional information
--------	------------	------------	--------------	---------------------------------	--------------	---------------------	-----------------------------------	-----------------	--------------------	---------------------	----------------	------------------------

[Book a test drive](#)[Buy your G-Class](#)[Find a Retailer](#)

G MANUFAKTUR package

The G MANUFAKTUR package offers a wealth of upholstery combinations, enhancing the individualisation of the iconic G-Class.

G MANUFAKTUR package (code DPM) – designed and priced as a package.

AMG Line Premium Plus and Mercedes-AMG G 63 only

Mercedes-AMG G 63 Magno Edition

**Total incl. VAT £7,995
Standard**

Consisting of:

Active Multicontour Seat package Plus

ENERGIZING comfort control

SUPERIOR Line Interior

Selecting Magno paint will replace AMG Night package with AMG Night package Magno.

All available upholstery:

902A Nappa leather black with contrasting topstitching in yacht blue

903A Nappa leather black with contrasting topstitching in white

907A Nappa leather black with contrasting topstitching in red

909A Nappa leather black with contrasting topstitching in gold

922A Nappa leather yacht blue/black

923A Nappa leather platinum white/black

927A Nappa leather bengal red/black

928A Nappa leather titanium grey pearl/black

934A Nappa leather saddle brown/black

916A Nappa leather black with accent band in lime green

917A Nappa leather black with accent band in bengal red

953A Nappa leather platinum white/black

957A Nappa leather bengal red/black

958A Nappa leather titanium grey pearl/black

964A Nappa leather saddle brown/black

801A Nappa leather black

805A Nappa leather macchiato beige/espresso brown*

827A Nappa leather classic red/black

825A Nappa leather truffle brown/black



923A+P77 Exclusive Nappa leather platinum white/black

*Available with G MANUFAKTUR seat belts in macchiato beige

Design	Technology	Model line	Model prices	Model line wheels, trims & uph.	Mercedes-AMG	Mercedes-AMG prices	Mercedes-AMG wheels, trims & uph.	Personalisation	Standard equipment	Genuine accessories	Technical data	Additional information
--------	------------	------------	--------------	---------------------------------	--------------	---------------------	-----------------------------------	-----------------	--------------------	---------------------	----------------	------------------------



Book a test drive



Buy your G-Class



Find a Retailer

G MANUFAKTUR package AMG Line Premium Plus



801A+P77 Exclusive Nappa leather black



907A+P77 Exclusive Nappa leather black with red topstitching



909A+P77 Exclusive Nappa leather black with gold topstitching



922A+P77 Exclusive Nappa leather yacht blue



964A+P77 Exclusive Nappa leather saddle brown/black



805A*+P77 Exclusive Nappa leather macchiato beige/espresso brown



902A+P77 Exclusive Nappa leather black with yacht blue topstitching



903A+P77 Exclusive Nappa leather black with white topstitching



923A+P77 Exclusive Nappa leather platinum white/black



927A+P77 Exclusive Nappa leather bengal red

*Available with G MANUFAKTUR seat belts in macchiato beige

Design	Technology	Model line	Model prices	Model line wheels, trims & uph.	Mercedes-AMG	Mercedes-AMG prices	Mercedes-AMG wheels, trims & uph.	Personalisation	Standard equipment	Genuine accessories	Technical data	Additional information
--------	------------	------------	--------------	---------------------------------	--------------	---------------------	-----------------------------------	-----------------	--------------------	---------------------	----------------	------------------------



Book a test drive



Buy your G-Class



Find a Retailer

G MANUFAKTUR package AMG Line Premium Plus



924A+P77 Exclusive Nappa leather espresso brown



934A+P77 Exclusive Nappa leather saddle brown



953A+P77 Exclusive Nappa leather platinum white/black



958A+P77 Exclusive Nappa leather titanium grey/black



928A+P77 Exclusive Nappa leather titanium grey pearl



916A+P77 Exclusive Nappa leather black with lime green A-band



917A+P77 Exclusive Nappa leather black with bengal red A-band



957A+P77 Exclusive Nappa leather bengal red/black

Design	Technology	Model line	Model prices	Model line wheels, trims & uph.	Mercedes-AMG	Mercedes-AMG prices	Mercedes-AMG wheels, trims & uph.	Personalisation	Standard equipment	Genuine accessories	Technical data	Additional information
--------	------------	------------	--------------	---------------------------------	--------------	---------------------	-----------------------------------	-----------------	--------------------	---------------------	----------------	------------------------



Book a test drive



Buy your G-Class



Find a Retailer

G MANUFAKTUR package Mercedes-AMG G 63



805A*+P77 Exclusive Nappa leather macchiato beige/espresso brown¹



909A+P77 Exclusive Nappa leather black with gold topstitching



922A+P77 Exclusive Nappa leather yacht blue



924A+P77 Exclusive Nappa leather espresso brown



934A+P77 Exclusive Nappa leather saddle brown



801A+P77 Exclusive Nappa leather black



902A+P77 Exclusive Nappa leather black with yacht blue topstitching



923A+P77 Exclusive Nappa leather platinum white/black



927A+P77 Exclusive Nappa leather bengal red



907A+P77 Exclusive Nappa leather black with red topstitching

*Available with G MANUFAKTUR seat belts in macchiato beige ¹805A/807A not available on Mercedes-AMG G 63 Magno Edition

Design	Technology	Model line	Model prices	Model line wheels, trims & uph.	Mercedes-AMG	Mercedes-AMG prices	Mercedes-AMG wheels, trims & uph.	Personalisation	Standard equipment	Genuine accessories	Technical data	Additional information
--------	------------	------------	--------------	---------------------------------	--------------	---------------------	-----------------------------------	-----------------	--------------------	---------------------	----------------	------------------------



Book a test drive



Buy your G-Class



Find a Retailer

G MANUFAKTUR package Mercedes-AMG G 63



916A+P77 Exclusive Nappa leather black with lime green A-band



953A+P77 Exclusive Nappa leather platinum white/black



958A+P77 Exclusive Nappa leather titanium grey/black



928A+P77 Exclusive Nappa leather titanium grey pearl



917A+P77 Exclusive Nappa leather black with bengal red A-band



957A+P77 Exclusive Nappa leather bengal red/black



964A+P77 Exclusive Nappa leather saddle brown/black

Design	Technology	Model line	Model prices	Model line wheels, trims & uph.	Mercedes-AMG	Mercedes-AMG prices	Mercedes-AMG wheels, trims & uph.	Personalisation	Standard equipment	Genuine accessories	Technical data	Additional information
--------	------------	------------	--------------	---------------------------------	--------------	---------------------	-----------------------------------	-----------------	--------------------	---------------------	----------------	------------------------



Rear Seat Entertainment package

Films, internet, video games or music: the Rear Seat Entertainment System, with a variety of interfaces for external media, ensures nobody gets bored. The two 10-inch touchscreens installed on the backrest boast brilliant picture quality. Pre-installation for the Rear Seat Entertainment system and well as a TV tuner form part of this package.

Rear Seat Entertainment package (code DRS) – designed and priced as a package.

All model lines

Total incl. VAT £3,495.00

Consisting of:

Digital TV tuner (front screen only – does not display in rear)

Internet access via browser and email client possible

Integral media player for playback of a variety of media

Two touchscreen displays with 10-inch screen diagonal for brilliant picture quality

USB 2.0, AUX and HDMI interfaces for the integration of smartphone content, laptop content or games consoles (SD memory cards via adapter)



Please note headphones are not included in this package. Any Bluetooth® headphone will, however, work with this system.

Design	Technology	Model line	Model prices	Model line wheels, trims & uph.	Mercedes-AMG	Mercedes-AMG prices	Mercedes-AMG wheels, trims & uph.	Personalisation	Standard equipment	Genuine accessories	Technical data	Additional information
--------	------------	------------	--------------	---------------------------------	--------------	---------------------	-----------------------------------	-----------------	--------------------	---------------------	----------------	------------------------

[Book a test drive](#)[Buy your G-Class](#)[Find a Retailer](#)

Night package

Add the Night package to your G 400 d to create an even bolder look. Heat-insulating dark-tinted glass in combination with the exterior mirrors and the spare wheel ring painted either obsidian black or Night black magno make for a striking appearance.

Night package (code P55) – designed and priced as a package, including items listed below.

AMG Line Premium Plus

Total incl. VAT £1,500.00

Selecting Magno paint will replace Night package with Night package Magno.

Consisting of:

Darkened indicators, tail lights and headlights

Spare wheel rim painted obsidian black

Exterior mirror housing painted obsidian black or night black magno (only in conjunction with magno paints)

Trim elements bumpers painted in obsidian black or night black magno (only in conjunction with magno paints)

Exterior protective strip with trim insert in black pinstripe or night black magno (only in conjunction with magno paints)



Magno paint shown



[Book a test drive](#)[Buy your G-Class](#)[Find a Retailer](#)

AMG Night package

Add the AMG Night package to your Mercedes-AMG G 63 to create an even bolder look. Heat-insulating dark-tinted glass in combination with the exterior mirrors and the spare wheel ring painted either obsidian black or Night black magno make for a striking appearance.

AMG Night package (code P56) – designed and priced as a package, including items listed below.

**Mercedes-AMG G 63 and
Mercedes-AMG G 63 Carbon Edition
Mercedes-AMG G 63 Magno Edition**

**Total incl. VAT £2,250.00
Standard**

Selecting Magno paint will replace AMG Night package with AMG Night package Magno.

Consisting of:

AMG-specific radiator grille, dark chrome-plated

Darkened indicators, tail lights as well as headlights

Exterior mirror housing painted obsidian black or night black magno (only in conjunction with magno paints)

Exterior protective strip with black trim insert in a pinstripe look

Simulated underguard in matt black

Spare wheel cover painted obsidian black or night black magno (only in conjunction with magno paints)

Trim elements in the bumper painted obsidian black or night black magno (only in conjunction with magno paints)



Magno paint shown



[Book a test drive](#)[Buy your G-Class](#)[Find a Retailer](#)

Optional equipment

○ Optional – Not available



CK4 G MANUFAKTUR bumpers and flared wheel arches in obsidian black

Mercedes-AMG G63	○
Mercedes-AMG G63 Carbon Edition	○
Mercedes-AMG G63 Magno Edition	–
Total RRP incl. VAT	£650.00



F85 [F86¹] G MANUFAKTUR roof painted in obsidian black [night black magno¹]

Mercedes-AMG G63	○	–
Mercedes-AMG G63 Carbon Edition	○	–
Mercedes-AMG G63 Magno Edition	–	○
Total RRP incl. VAT	£650.00	£900.00



ZI3 G MANUFAKTUR dashboard in two-tone nappa leather²

Mercedes-AMG G63	○
Mercedes-AMG G63 Carbon Edition	○
Mercedes-AMG G63 Magno Edition	○
Total RRP incl. VAT	£650.00

¹Available for Magno Edition only ²Only in conjunction with DPM

[Book a test drive](#)[Buy your G-Class](#)[Find a Retailer](#)

Standard equipment AMG Line Premium Plus

Transmission and Suspension

4MATIC Permanent four-wheel drive with three 100% differentials

9G-TRONIC transmission with cruise control and variable speed limiter

DYNAMIC SELECT with ECO start/stop function and four transmission modes: 'C' (Comfort), 'S' (Sport), 'I' (Individual) and 'M' (Manual)

Suspension with adaptive damping adjustment

Exterior

Adaptive Highbeam Assist Plus – the driver is free to concentrate on the traffic without constantly having to select between low and high beam

Ambient lighting with projection of brand logo

AMG bodystyling with flared wheel arches in vehicle colour

Brake calipers with 'Mercedes-Benz' lettering

Bumpers – painted in body colour, front and rear

Diesel particulate filter

Differential locks (transfer case, front and rear axle)

Door mirrors – electrically adjustable and heated Integrated indicators, front area lighting and automatically dimming driver's mirror

Electric sunroof – sliding, with one-touch opening

Exterior protective strip with trim insert in brushed aluminium

Heated windscreen

Low range gear reduction (electronically selectable while driving)

MULTIBEAM LED headlamps enable continuous main beam without dazzling other road users. Individually controlled LEDs precisely mask out other vehicles and at the same time illuminate the surroundings in light which is almost as bright as daylight.

Parking package with 360° camera

Privacy glass – dark grey-tinted glass for tailgate and rear side windows

Rain-sensing wipers

Running boards

Spare wheel ring painted in obsidian black

Stainless-steel spare wheel cover

Summer tyres

Tail lights featuring LED technology

Trailer coupling with ESP® trailer stabilisation

Underguard - reinforced underfloor panelling the full length of the vehicle

Interior

12V sockets in centre console, rear and load compartment

Ambient lighting – 64 colours

AMG floor mats with 'AMG' lettering

Automatically dimming rear-view mirror

Centre armrest between front seats with integrated stowage compartment

Design	Technology	Model line	Model prices	Model line wheels, trims & uph.	Mercedes-AMG	Mercedes-AMG prices	Mercedes-AMG wheels, trims & uph.	Personalisation	Standard equipment	Genuine accessories	Technical data	Additional information
--------	------------	------------	--------------	---------------------------------	--------------	---------------------	-----------------------------------	-----------------	--------------------	---------------------	----------------	------------------------

[Book a test drive](#)[Buy your G-Class](#)[Find a Retailer](#)

Standard equipment

AMG Line Premium Plus

Interior (continued)

Cup holders – front (2) and rear (2)

Dashboard – Nappa Leather

Electric windows (4)

Front seats – heated and electrically adjustable. Memory function for seats, head restraints, exterior mirrors and steering wheel

Ionisation of interior air including fine-particle activated charcoal filter system

KEYLESS-GO starting function

Luggage compartment cover

Luggage protection net

Rear bench seat – split folding 1/3:2/3

Rear seats – heated

Seat belts, 3-point design in black

Seat belt pre-tensioners (4)

Stainless steel door sill panels, set of four, illuminated, with 'Mercedes-Benz' lettering at the front

Stowage Space package – including removable double cup holder in centre console, bottle holders in door pockets, map pockets on back of front seats, and glasses compartment in overhead control panel

THERMOTRONIC automatic climate control with three climate zones and three climate styles:

Medium, Diffuse and Focused

Ventilated multicontour front seats

Widescreen cockpit with dual bonded 12.3" widescreen displays

Steering

Multifunction sports steering wheel in nappa leather 3-spoke design, with flattened bottom section, steering wheel trim and shift paddles in silver chrome and Touch Control buttons

Steering column – electrically adjustable, with automatic adjustment for entry/exit

Paint, Trim and Upholstery

Paint – metallic

Roof lining – MANUFAKTUR black DINAMICA microfibre

Trim – G MANUFAKTUR black flamed open-pore ash wood

Upholstery – AMG Line nappa leather, black

Communications and In-Car Entertainment

Bluetooth® interface for hands-free telephony

COMAND Online – online-capable multimedia system with display (12.3 inches), touchpad with controller, Touch Control buttons on the steering wheel and LINGUATRONIC voice control system, hard-disk navigation with satellite map display, smartphone integration, communications module for Mercedes me services, 3 years of free online map updates, Live Traffic Information, Mercedes me connect Standard Services, Mercedes-Benz apps, Mercedes-Benz emergency call system, Car-to-X-Communication

Communications module (LTE) for the use of Mercedes me connect services – preparation for use of Mercedes me connect services with particularly rapid and dependable data transfer

DAB digital radio tuner

Smartphone integration¹ comprising Apple CarPlay® and Android Auto™ – see www.apple.com/uk/ios/carplay/ or www.android.com/intl/en_uk/auto for compatibility and approved apps. Certain features and apps require a 3G/4G data connection. Control of features available through voice control and controller on centre console

¹Compatible mobile phone required

Design	Technology	Model line	Model prices	Model line wheels, trims & uph.	Mercedes-AMG	Mercedes-AMG prices	Mercedes-AMG wheels, trims & uph.	Personalisation	Standard equipment	Genuine accessories	Technical data	Additional information
--------	------------	------------	--------------	---------------------------------	--------------	---------------------	-----------------------------------	-----------------	--------------------	---------------------	----------------	------------------------



Book a test drive



Buy your G-Class



Find a Retailer

Standard equipment AMG Line Premium Plus

Communications and In-Car Entertainment (continued)

Surround sound system – Burmester® surround sound system
16 high-performance speakers as well as electronics and acoustic features tailored specifically to the interior make for the first-class Burmester sound

Touchpad with controller

Safety and Assistance Systems

Active Brake Assist¹ – consisting of proximity and collision warning, situation-dependent braking assistance and also autonomous braking function for vehicles in front, crossing pedestrians and cyclists

Active Blind Spot Assist¹

Active Lane Keeping Assist¹

ADAPTIVE BRAKE with HOLD function, Hill-Start Assist, priming and dry braking in the wet

Airbags – driver and front passenger

Airbags – front side

Airbags – sidebags in rear

Airbags – windowbags

Anti-lock braking system (ABS) with Brake Assist (BAS)

Anti-theft alarm system with tow-away protection and interior motion sensor (Thatcham Category 1 compliant)

ATTENTION ASSIST – can detect typical symptoms of drowsiness on the basis of driver behaviour and alert the driver to increasing fatigue and inattention

Driving Assistance package¹ consisting of Blind Spot Assist and Distance Assist DISTRONIC

Electronic Stability Programme (ESP®) with Acceleration Skid Control (ASR)

Four-wheel Electronic Traction System (4ETS)

Headlight Assist – automatic headlamp activation

i-Size child seat attachment system for outer rear seats

Parking Assist PARKTRONIC

PRE-SAFE® system – preventive occupant protection

Service indicator ASSYST

Traffic Sign Assist

Tyre pressure monitoring system

¹Our driver assistance and safety systems are aids and do not relieve you of your responsibility as the driver. Please take note of the information in the Owner's Manual and the system limits which are described therein

Design	Technology	Model line	Model prices	Model line wheels, trims & uph.	Mercedes-AMG	Mercedes-AMG prices	Mercedes-AMG wheels, trims & uph.	Personalisation	Standard equipment	Genuine accessories	Technical data	Additional information
--------	------------	------------	--------------	---------------------------------	--------------	---------------------	-----------------------------------	-----------------	--------------------	---------------------	----------------	------------------------

[Book a test drive](#)[Buy your G-Class](#)[Find a Retailer](#)

Standard equipment Mercedes-AMG

● Standard – Not available

Transmission and Suspension

	G 63	G 63 Carbon Edition	G 63 Magno Edition
4MATIC Permanent four-wheel drive with three 100% differentials	●	●	●
AMG DYNAMIC SELECT with ECO start/stop function and 5 transmission modes 'C' (Comfort), 'S' (Sport), S+ (Sport Plus) and 'M' (Manual)	●	●	●
AMG high-performance braking system with internally ventilated and perforated brake discs measuring 400 x 38 mm at the front, 370 x 22 mm at the rear	●	●	●
AMG RIDE CONTROL suspension with three settings 'C' (Comfort), 'S' (Sport), S+ (Sport Plus) accessible via DYNAMIC SELECT	●	●	●
AMG SPEEDSHIFT 9G-TRONIC sports transmission with cruise control and variable speed limiter	●	●	●

Exterior

Adaptive Highbeam Assist Plus – the driver is free to concentrate on the traffic without constantly having to select between low and high beam	●	●	●
Ambient lighting with projection of brand logo	●	●	●
AMG bodystyling with Mercedes-AMG G 63 front aprons with cooling air intakes and flared wheel arches in vehicle colour and bumpers painted in body colour, front and rear	●	●	–
AMG bodystyling with exclusive AMG flared wheel arches and bumpers in night black magno	–	–	●
AMG brake callipers, painted red	●	●	●
AMG Night package	–	●	–
AMG Night package Magno	–	–	●
AMG Night package II – typography in high-gloss black and Mercedes-Benz star in high-gloss black front and rear	–	–	●
AMG performance exhaust system, selectable and two chrome-trimmed twin tailpipes, left and right	●	●	●
AMG-specific radiator grille with AMG logo	●	●	●
Differential locks (transfer case, front and rear axle)	●	●	●

	G 63	G 63 Carbon Edition	G 63 Magno Edition
Door mirrors – electrically adjustable and heated Integrated indicators, front area lighting and automatically dimming driver's mirror	●	●	●
Electric sunroof – sliding, with one-touch opening	●	●	●
Exterior mirror housings in black	–	●	●
Exterior protective strip with trim insert in black	●	●	●
Heated windscreen	●	●	●
Low range gear reduction (electronically selectable while driving)	●	●	●
MULTIBEAM LED headlamps enable continuous main beam without dazzling other road users. Individually controlled LEDs precisely mask out other vehicles and at the same time illuminate the surroundings in light which is almost as bright as daylight	●	●	●
Parking-assistance PARKTRONIC	●	●	●
Parking package with 360° camera	●	●	●
Petrol particulate filter	●	●	●
Privacy glass – dark grey-tinted glass for tailgate and rear side windows	●	●	●
Rain-sensing wipers	●	●	●
Running boards	●	●	●
Spare wheel ring painted in black	–	●	–
Spare wheel ring painted in night black magno	–	–	●
Stainless-steel spare wheel cover	●	●	–
Summer tyres	●	●	●
Tail lights featuring LED technology	●	●	●
Trailer coupling with ESP® trailer stabilisation	●	●	●

[Book a test drive](#)[Buy your G-Class](#)[Find a Retailer](#)

Standard equipment Mercedes-AMG

● Standard – Not available

Interior

	G 63	G 63 Magno Edition	G 63 Carbon Edition
12V sockets in centre console, rear and load compartment	●	●	●
Active Multicontour Seat package Plus – SUPERIOR Line interior, dashboard in nappa leather	–	–	●
Ambient lighting – 64 colours	●	●	●
AMG door sill panels in brushed stainless steel, illuminated	●	●	●
AMG floor mats with 'AMG' lettering	●	●	●
AMG instrument cluster with dual bonded 12.3" widescreen displays	●	●	●
AMG-specific IWC-design analogue clock	●	●	●
AMG steering wheel buttons	●	●	●
Automatically dimming rear-view mirror	●	●	●
Centre armrest between front seats with integrated stowage compartment	●	●	●
Cup holders – front (2) and rear (2)	●	●	●
Dashboard – Nappa Leather	●	●	●
Electric windows (4)	●	●	●
ENERGIZING comfort control	–	–	●
Front seats – heated and electrically adjustable. Memory function for seats, head restraints, exterior mirrors and steering wheel	●	●	●
Ionisation of interior air including fine-particle activated charcoal filter system	●	●	●
KEYLESS-GO starting function	●	●	●
Luggage compartment cover	●	●	●
Luggage protection net	●	●	●
Rear bench seat – split folding 1/3:2/3	●	●	●
Rear seats – heated	●	●	●
Seat belts, 3-point design in black	●	●	●

	G 63	G 63 Magno Edition	G 63 Carbon Edition
Seat belt pre-tensioners (4)	●	●	●
Stowage Space package – including removable double cup holder in centre console, bottle holders in door pockets, map pockets on back of front seats, and glasses compartment in overhead control panel	●	●	●
THERMOTRONIC automatic climate control with three climate zones and three climate styles: Medium, Diffuse and Focused	●	●	●
Ventilated multicontour front seats	●	●	●

Steering

	G 63	G 63 Magno Edition	G 63 Carbon Edition
AMG performance steering wheel in carbon fibre/DINAMICA microfibre 3-spoke design, with flattened bottom section, steering wheel trim in silver chrome with 'AMG' lettering and silver-coloured aluminium shift paddles, 12 o'clock marking and Touch Control buttons	–	●	●
AMG performance steering wheel in nappa leather 3-spoke design, with flattened bottom section, steering wheel trim in silver chrome with 'AMG' lettering and silver-coloured aluminium shift paddles, 12 o'clock marking and touch control buttons	●	–	●
Steering column – electrically adjustable, with automatic adjustment for entry/exit	●	●	●

Paint, Trim and Upholstery

	G 63	G 63 Magno Edition	G 63 Carbon Edition
Paint – magno	–	–	●
Paint – metallic	●	●	–
Roof lining – MANUFAKTUR black DINAMICA microfibre	●	●	●
Trim – AMG carbon fibre	–	●	●
Trim – G MANUFAKTUR black piano lacquer	●	–	–
Upholstery – AMG G MANUFAKTUR superior interior with Nappa leather	–	–	●
Upholstery – AMG G MANUFAKTUR exclusive interior with Nappa leather	●	●	–

[Book a test drive](#)[Buy your G-Class](#)[Find a Retailer](#)

Standard equipment Mercedes-AMG

● Standard – Not available

Communications and In-Car Entertainment

	G 63	G 63 Carbon Edition	G 63 Magno Edition
Bluetooth® interface for hands-free telephony	●	●	●
COMAND Online – online-capable multimedia system with display (12.3 inches), touchpad with controller, Touch Control buttons on the steering wheel and LINGUATRONIC voice control system, hard-disk navigation with satellite map display, smartphone integration, communications module for Mercedes me services, 3 years of free online map updates, Live Traffic Information, Mercedes me connect Standard Services, Mercedes-Benz apps, Mercedes-Benz emergency call system, Car-to-X-Communication	●	●	●
Communications module (LTE) for the use of Mercedes me connect services – preparation for use of Mercedes me connect services with particularly rapid and dependable data transfer	●	●	●
DAB digital radio tuner	●	●	●
Smartphone integration ¹ comprising Apple CarPlay® and Android Auto™ – see www.apple.com/uk/ios/carplay/ or www.android.com/intl/en_uk/auto for compatibility and approved apps. Certain features and apps require a 3G/4G data connection. Control of features available through voice control and controller on centre console	●	●	●
Surround sound system – Burmester® surround sound system 16 high-performance speakers as well as electronics and acoustic features tailored specifically to the interior make for the first-class Burmester sound	●	●	●
Touchpad with controller	●	●	●

Safety and Assistance Systems

	G 63	G 63 Carbon Edition	G 63 Magno Edition
Active Brake Assist ² – consisting of proximity and collision warning, situation-dependent braking assistance and also autonomous braking function for vehicles in front, crossing pedestrians and cyclists	●	●	●
Active Lane Keeping Assist ²	●	●	●
Active Blind Spot Assist ²	●	●	●
ADAPTIVE BRAKE with HOLD function, Hill-Start Assist, priming and dry braking in the wet	●	●	●
Airbags – driver and front passenger	●	●	●
Airbags – front side	●	●	●
Airbags – sidebags in rear	●	●	●
Airbags – windowbags	●	●	●
Anti-lock braking system (ABS) with Brake Assist (BAS)	●	●	●
Anti-theft alarm system with tow-away protection and interior motion sensor (Thatcham Category 1 compliant)	●	●	●
ATTENTION ASSIST – can detect typical symptoms of drowsiness on the basis of driver behaviour and alert the driver to increasing fatigue and inattention	●	●	●
Driving Assistance package ² consisting of Blind Spot Assist and Distance Assist DISTRONIC	●	●	●
Electronic Stability Programme (ESP®) with Acceleration Skid Control (ASR)	●	●	●
Four-wheel Electronic Traction System (4ETS)	●	●	●
Headlight Assist – automatic headlamp activation	●	●	●
i-Size child seat attachment system for outer rear seats	●	●	●
Parking Assist PARKTRONIC	●	●	●
PRE-SAFE® system – preventive occupant protection	●	●	●
Service indicator ASSYST	●	●	●
Traffic Sign Assist	●	●	●
Tyre pressure monitoring system	●	●	●

¹Compatible mobile phone required

²Our driver assistance and safety systems are aids and do not relieve you of your responsibility as the driver. Please take note of the information in the Owner's Manual and the system limits which are described therein

Genuine accessories

We've developed a range of Accessories you can add to help personalise and enhance your G-Class.



Mercedes-Benz roof box 450

Impact-resistant, sturdy, durable, recyclable, spray-protected. Opens on both sides. Single lock system with three locking mechanisms on each side. Gas-filled struts for easy opening and closing of lid. Straps to hold contents in place. Maximum load capacity of 75 kg. (A0008401200)



Bicycle rack

Easy to use, convenient and lightweight. Bicycles can be attached at ground level before the rack is fitted. Up to three bicycle carriers can be fitted at one time. The alustyle cycle carrier is designed for the alustyle basic carrier bars, making your life easier, with know-how from Mercedes-Benz. (A0008900293)

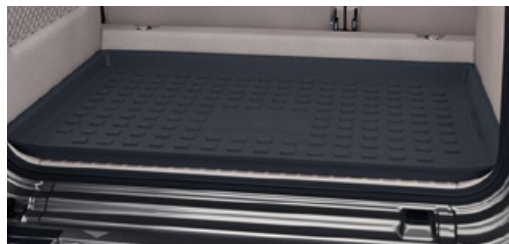

Boot tub, shallow

For your everyday requirements the easy-clean boot tub suits all of your needs. The shape of the tub, with its slightly raised edge, is tailored to the boot with the honeycomb structure preventing slipping. (A4638140000)



Concertina load sill protector

The concertina load sill protector not only protects the boot, but also protects the bumper and boot sill from becoming scratched. As the mat can be folded out, even your clothes stay clean when loading. The load sill guard can be attached via hooks to the lifting eyes or can be attached via a velcro strip to the reversible mat or roof box. (A2536932000)



Basic carrier bars, three crossbars

Aluminium carrier bars, precision-tailored to the body of your Mercedes-Benz – the perfect basis for a range of Mercedes-Benz transport accessories: ski and snowboard rack, bicycle rack or roof boxes. Fitted in next to no time without the use of tools, thanks to new, innovative quick-release fasteners. (A4638902900)



AMG indoor car cover

Silver-coloured, with black AMG lettering. The breathable outer layer in tearproof synthetic fibre and the antistatic inner layer in flannel protect the vehicle against dust and scratches. Elasticated edging at the front and rear ensures that the cover stays in place and provides an ideal fit, particularly for AMG models. (A4638990500)

All the above accessories are subject to availability and compatibility. Please ask your Mercedes-Benz Retailer for more information

Design	Technology	Model line	Model prices	Model line wheels, trims & uph.	Mercedes-AMG	Mercedes-AMG prices	Mercedes-AMG wheels, trims & uph.	Personalisation	Standard equipment	Genuine accessories	Technical data	Additional information
--------	------------	------------	--------------	---------------------------------	--------------	---------------------	-----------------------------------	-----------------	--------------------	---------------------	----------------	------------------------

[Book a test drive](#)[Buy your G-Class](#)[Find a Retailer](#)

Technical data

● Standard – Not available

Model	G 400 d		Mercedes-AMG G 63
Engine			
Fuel delivery	Diesel		Petrol
Total displacement	cc	2,925	3,982
Arrangement/cylinders/valves	in-line/6/24		V/8/32
Power ¹	hp (kW) at rpm	326 (243)/3,600–4,200	577 (430)/6,000
Torque ¹	Nm at rpm	700/1,200–3,200	850/2,500–3,500
Compression ratio	15.5:1		8.6:1
Emissions standard	EURO 6D-ISC-FCM		EURO 6D-ISC-FCM
Transmission			
9G-TRONIC automatic	●		–
AMG SPEEDSHIFT PLUS 9G-TRONIC	–		●
Performance			
Acceleration 0–62 mph	sec	6.4	4.5
Top speed (electric mode) ²	mph	130	137
Weights and capacities			
Kerb weight ³	kg	2,508	2,560
Perm. Gross Vehicle Weight	kg	3,150	3,200
Boot capacity – seats up		667	667
seats down	l	1,941	1,941
Towing capacity – unbraked		750	750
braked	kg	3,500	3,500

¹Figures according to Directive 80/1269/EEC in the currently applicable version ²Electronically limited ³Mass of the vehicle in running order with at least 90% full fuel tank, plus the mass of the driver (estimated by law at 75 kg), fuel and fluids, equipped with the standard equipment as specified by the manufacturer as well as, where applicable, the mass of the body, cab, trailer coupling and spare wheel(s) as well as tools. Optional extras, additional equipment and accessories can influence the weight, residual payload, rolling resistance, aerodynamics, etc., and therefore also affect the consumption/CO₂ values

[Book a test drive](#)[Buy your G-Class](#)[Find a Retailer](#)

Technical data

Model		G 400 d		Mercedes-AMG G 63
Weights and capacities (cont.)				
Fuel tank capacity/of which reserve	l	100/12		100/12
Turning circle	m	13.6		13.5

Fuel consumption^{4,5,6}				
Combined (consumption dependent on chosen optional equipment)	l/100 km	11.0		16.0
	mpg	25.7		17.7

Insurance				
Group rating		50E		50E

Insurance ratings may vary depending on model line and specification. Please refer to <http://www.thatcham.org/abigrouprating/> for further details

⁴All figures are based on a standard specification with the smallest tyre size available in the UK

⁵The choice of wheels and transmission may affect CO₂ emissions and corresponding Road Fund Licence

⁶The indicated values were determined according to the prescribed measurement method - Worldwide Harmonised Light Vehicle Test Procedure (WLTP). Figures shown may include options which are not available in the UK



Book a test drive



Buy your G-Class



Find a Retailer

Edition/Premium/Premium Plus

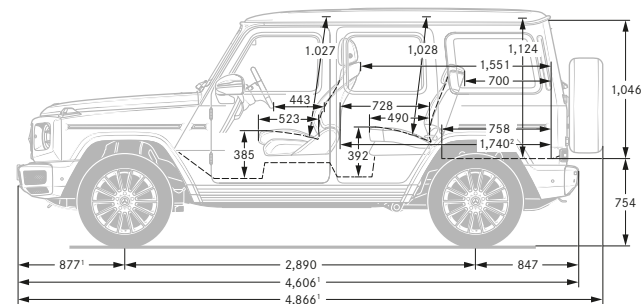
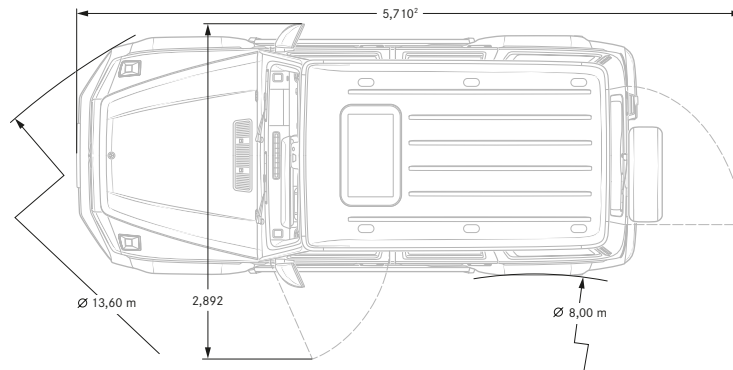
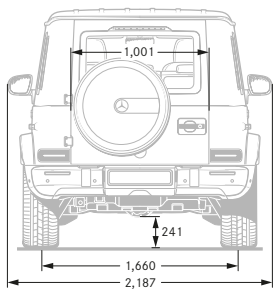
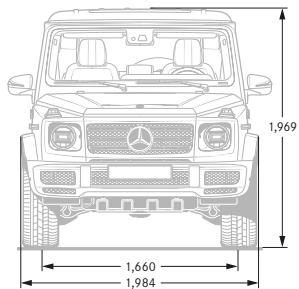

Mercedes-AMG G 63

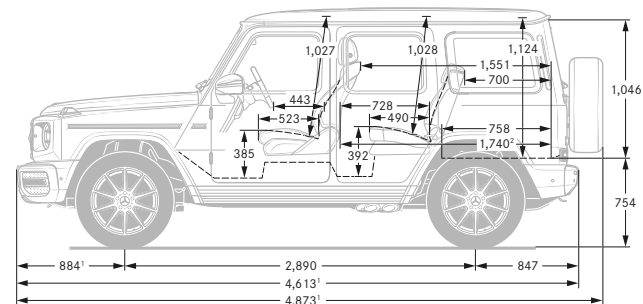
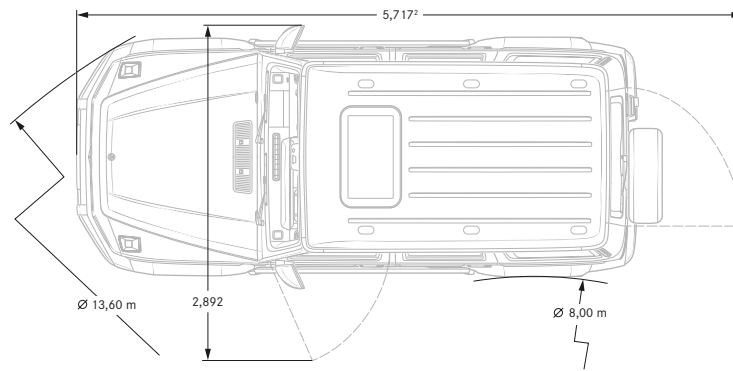
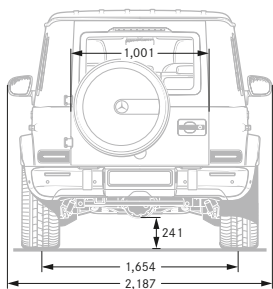
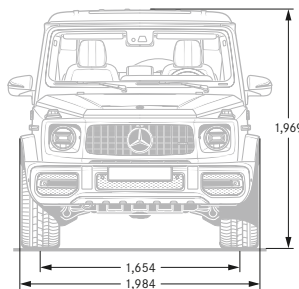

Design	Technology	Model line	Model prices	Model line wheels, trims & uph.	Mercedes-AMG	Mercedes-AMG prices	Mercedes-AMG wheels, trims & uph.	Personalisation	Standard equipment	Genuine accessories	Technical data	Additional information
--------	------------	------------	--------------	---------------------------------	--------------	---------------------	-----------------------------------	-----------------	--------------------	---------------------	----------------	------------------------



Book a test drive



Buy your G-Class



Find a Retailer

Edition/Premium/Premium Plus – Boot capacity

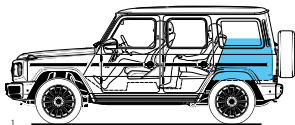

Open luggage compartment behind rear seat, loaded to upper edge of rear seat backrest, volume 621 litres, with backrest in cargo position: volume 667 litres

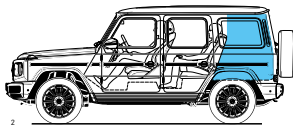

Open luggage compartment behind rear seat, loaded to roof, volume 1,031 litres, with backrest in cargo position: volume 1,080 litres

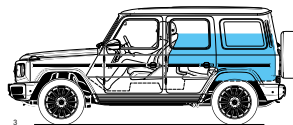

Open luggage compartment behind driver's seat, rear seat backrest folded, loaded to upper edge of driver's backrest, volume 1,246 litres

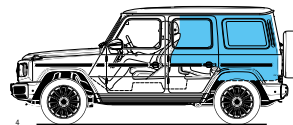

Open luggage compartment behind driver's seat, rear seat backrest folded, loaded to roof, volume 1,941 litres

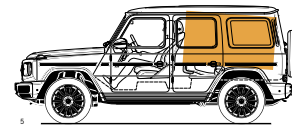

Largest cuboid: Dimensions 1,420 × 960 × 50 mm, volume 1,150 litres

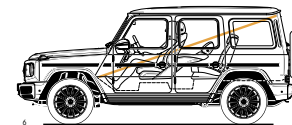

Longest board: Dimensions 2,700 × 400 × 30 mm

Mercedes-AMG G 63 – Boot capacity

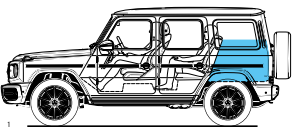

Open luggage compartment behind rear seat, loaded to upper edge of rear seat backrest, volume 621 litres, with backrest in cargo position: volume 667 litres

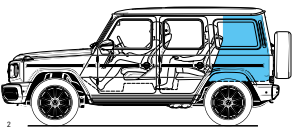

Open luggage compartment behind rear seat, loaded to roof, volume 1,031 litres, with backrest in cargo position: volume 1,080 litres

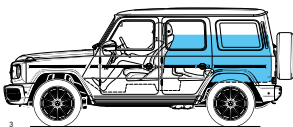

Open luggage compartment behind driver's seat, rear seat backrest folded, loaded to upper edge of driver's backrest, volume 1,246 litres

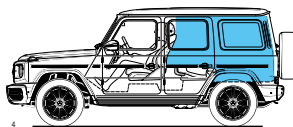

Open luggage compartment behind driver's seat, rear seat backrest folded, loaded to roof, volume 1,941 litres

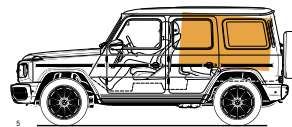

Largest cuboid: Dimensions 1,420 × 960 × 850 mm, volume 1,150 litres

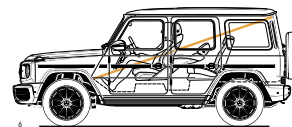

Longest board: Dimensions 2,700 × 400 × 30 mm

Design	Technology	Model line	Model prices	Model line wheels, trims & uph.	Mercedes-AMG	Mercedes-AMG prices	Mercedes-AMG wheels, trims & uph.	Personalisation	Standard equipment	Genuine accessories	Technical data	Additional information
--------	------------	------------	--------------	---------------------------------	--------------	---------------------	-----------------------------------	-----------------	--------------------	---------------------	----------------	------------------------



Road Fund Licence

All road vehicle registrations are subject to Vehicle Excise Duty (Road Fund Licence), which varies in accordance with the vehicle's CO₂ emissions. A first year rate for each taxation band will apply. The table below shows the bands (A-M) created by the DVLA and the corresponding Road Fund Licence. CO₂ emissions and the relevant Excise Duty are shown on the model pricing pages.

Band	CO ₂ emissions (g/km)	First year rate petrol and RDE2 diesel (£)	First year rate all other diesel (£) ¹	First year rate alternative fuel (£)	Electric vehicles		Alternative fuel vehicles		Petrol/diesel vehicles	
					Standard rate (£)	Premium rate (£) ²	Standard rate (£)	Premium rate (£) ²	Standard rate (£)	Premium rate (£) ²
A	0	0.00	0.00	0.00	0.00	0.00	0.00	0.00	0.00	0.00
B	1 to 50	10.00	25.00	0.00	0.00	0.00	155.00	510.00	165.00	520.00
C	51 to 75	25.00	120.00	15.00	0.00	0.00	155.00	510.00	165.00	520.00
D	76 to 90	120.00	150.00	110.00	0.00	0.00	155.00	510.00	165.00	520.00
E	91 to 100	150.00	170.00	140.00	0.00	0.00	155.00	510.00	165.00	520.00
F	101 to 110	170.00	190.00	160.00	0.00	0.00	155.00	510.00	165.00	520.00
G	111 to 130	190.00	230.00	180.00	0.00	0.00	155.00	510.00	165.00	520.00
H	131 to 150	230.00	585.00	220.00	0.00	0.00	155.00	510.00	165.00	520.00
I	151 to 170	585.00	945.00	575.00	0.00	0.00	155.00	510.00	165.00	520.00
J	171 to 190	945.00	1,420.00	935.00	0.00	0.00	155.00	510.00	165.00	520.00
K	191 to 225	1,420.00	2,015.00	1,410.00	0.00	0.00	155.00	510.00	165.00	520.00
L	226 to 255	2,015.00	2,365.00	2,005.00	0.00	0.00	155.00	510.00	165.00	520.00
M	over 255	2,365.00	2,365.00	2,355.00	0.00	0.00	155.00	510.00	165.00	520.00



Some of the model features, optional extras and colours shown may not be available, or may only be available in a different specification

¹Applies to all Mercedes-Benz diesel models which do not comply with RDE (Real Driving Emissions) Step 2 Certified (Euro 6d)

²Premium rate only applicable to vehicles where the list price is over £40,000 including any factory-fitted options, standard UK delivery charge and VAT

Design	Technology	Model line	Model prices	Model line wheels, trims & uph.	Mercedes-AMG	Mercedes-AMG prices	Mercedes-AMG wheels, trims & uph.	Personalisation	Standard equipment	Genuine accessories	Technical data	Additional information
--------	------------	------------	--------------	---------------------------------	--------------	---------------------	-----------------------------------	-----------------	--------------------	---------------------	----------------	------------------------



Services and insurance

Mercedes-Benz ServiceCare

We believe that servicing costs should be as flexible and affordable as possible for your G-Class, which is why we offer ServiceCare, an easy way to budget for all your servicing costs. It spreads your bills into manageable payments based on whether you have a new or used Mercedes-Benz. With ServiceCare we guarantee the price of parts and labour for up to four services and safeguard against any further inflation. It also covers the cost of all recommended service items including brake fluid, spark plugs, air filters, fuel filters and screen wash. You can choose either to add your servicing costs into your monthly spend or pay the full amount in a one-off payment, giving you peace of mind that they are taken care of for the period of the plan.

[› Click here for more information](#)

Warranty and breakdown cover

Every Mercedes-Benz comes with a three-year unlimited mileage warranty against manufacturing or material defects¹ and up to 30 years warranty against perforation due to corrosion from the inside out.² What's more, it's also covered by Mercedes-Benz Roadside Assistance – a unique package comprising up to 30 years pan-European breakdown assistance.²

Motor Insurance

We know that once you have chosen your Mercedes-Benz you can't wait to drive it – that's why we created First Cover³. It gives you 7 days' free comprehensive Motor Insurance when you buy a new or used vehicle from a Mercedes-Benz Retailer. We will also send you a quote for annual cover, so you can enjoy the same peace of mind all year round.

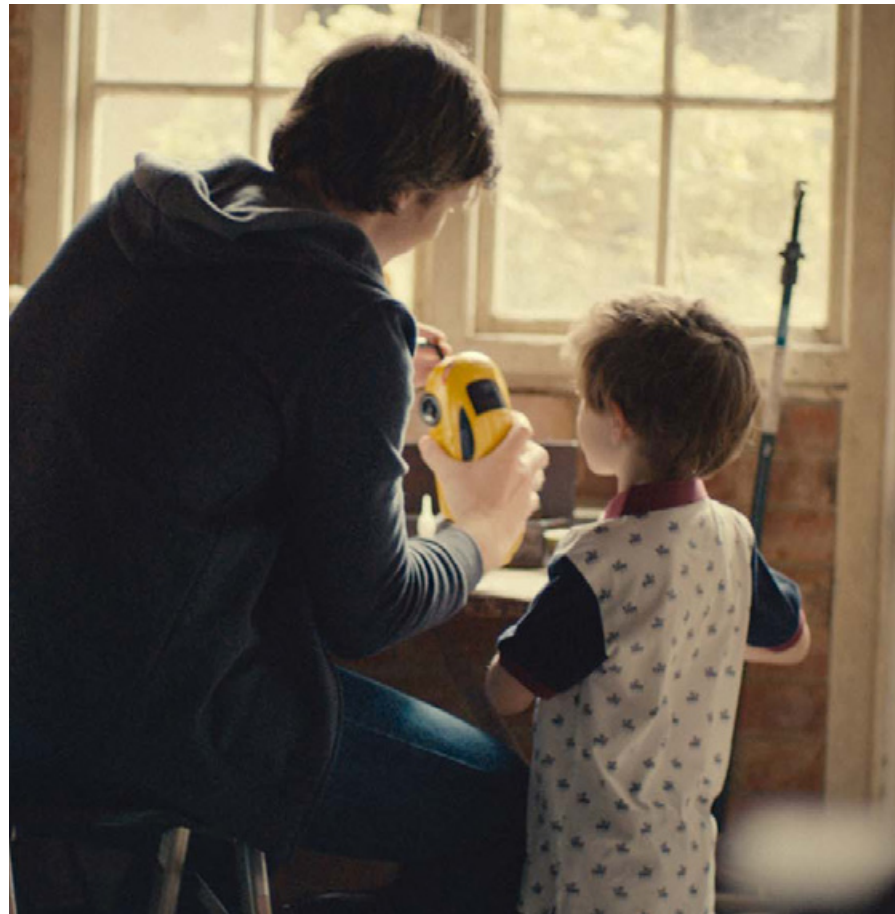
[› Apply for First Cover](#)

¹Applies to vehicles sold by Mercedes-Benz in the UK to its franchised Retailers ²Subject to full Terms and Conditions, dependent on date of registration, available upon request
³Terms and Conditions apply. We are an independent intermediary dealing with selected insurers in respect of annual insurance

Design	Technology	Model line	Model prices	Model line wheels, trims & uph.	Mercedes-AMG	Mercedes-AMG prices	Mercedes-AMG wheels, trims & uph.	Personalisation	Standard equipment	Genuine accessories	Technical data	Additional information
--------	------------	------------	--------------	---------------------------------	--------------	---------------------	-----------------------------------	-----------------	--------------------	---------------------	----------------	------------------------



Effective from May 2022 Production. Information correct at time of publication 01.04.2022.
Prices and specifications are subject to change without prior notice.
MBW463PL/0722 MY X21

