



The new GLS

Effective from January 2025 Production.

Mercedes-Benz



[Book a test drive](#)[Find your new GLS](#)[Find a Showroom](#)

Some of the model features, optional extras and colours shown may not be available, or may only be available in a different specification, or at a different price.

Design	Technology	GLS	Mercedes-AMG GLS	Mercedes-Maybach GLS	Model prices	Personalisation	Standard equipment	Genuine accessories	Technical data	Additional information
------------------------	----------------------------	---------------------	----------------------------------	--------------------------------------	------------------------------	---------------------------------	------------------------------------	-------------------------------------	--------------------------------	--



Book a test drive



Find your new GLS



Find a Showroom



Some of the model features, optional extras and colours shown may not be available, or may only be available in a different specification, or at a different price.

Design	Technology	GLS	Mercedes-AMG GLS	Mercedes-Maybach GLS	Model prices	Personalisation	Standard equipment	Genuine accessories	Technical data	Additional information
--------	------------	-----	------------------	----------------------	--------------	-----------------	--------------------	---------------------	----------------	------------------------



Book a test drive



Find your new GLS



Find a Showroom



Some of the model features, optional extras and colours shown may not be available, or may only be available in a different specification, or at a different price.

Design	Technology	GLS	Mercedes-AMG GLS	Mercedes-Maybach GLS	Model prices	Personalisation	Standard equipment	Genuine accessories	Technical data	Additional information
--------	------------	-----	------------------	----------------------	--------------	-----------------	--------------------	---------------------	----------------	------------------------

[Book a test drive](#)[Find your new GLS](#)[Find a Showroom](#)

Some of the model features, optional extras and colours shown may not be available, or may only be available in a different specification, or at a different price.

Design	Technology	GLS	Mercedes-AMG GLS	Mercedes-Maybach GLS	Model prices	Personalisation	Standard equipment	Genuine accessories	Technical data	Additional information
------------------------	----------------------------	---------------------	----------------------------------	--------------------------------------	------------------------------	---------------------------------	------------------------------------	-------------------------------------	--------------------------------	--



Some of the model features, optional extras and colours shown may not be available, or may only be available in a different specification, or at a different price.

Design	Technology	GLS	Mercedes-AMG GLS	Mercedes-Maybach GLS	Model prices	Personalisation	Standard equipment	Genuine accessories	Technical data	Additional information
------------------------	----------------------------	---------------------	----------------------------------	--------------------------------------	------------------------------	---------------------------------	------------------------------------	-------------------------------------	--------------------------------	--



Book a test drive



Find your new GLS



Find a Showroom



Some of the model features, optional extras and colours shown may not be available, or may only be available in a different specification, or at a different price.

Design	Technology	GLS	Mercedes-AMG GLS	Mercedes-Maybach GLS	Model prices	Personalisation	Standard equipment	Genuine accessories	Technical data	Additional information
--------	------------	-----	------------------	----------------------	--------------	-----------------	--------------------	---------------------	----------------	------------------------

[Book a test drive](#)[Find your new GLS](#)[Find a Showroom](#)

Some of the model features, optional extras and colours shown may not be available, or may only be available in a different specification, or at a different price.

Design	Technology	GLS	Mercedes-AMG GLS	Mercedes-Maybach GLS	Model prices	Personalisation	Standard equipment	Genuine accessories	Technical data	Additional information
------------------------	----------------------------	---------------------	----------------------------------	--------------------------------------	------------------------------	---------------------------------	------------------------------------	-------------------------------------	--------------------------------	--



Book a test drive



Find your new GLS



Find a Showroom



Some of the model features, optional extras and colours shown may not be available, or may only be available in a different specification, or at a different price.

Design	Technology	GLS	Mercedes-AMG GLS	Mercedes-Maybach GLS	Model prices	Personalisation	Standard equipment	Genuine accessories	Technical data	Additional information
--------	------------	-----	------------------	----------------------	--------------	-----------------	--------------------	---------------------	----------------	------------------------



Book a test drive



Find your new GLS



Find a Showroom



Some of the model features, optional extras and colours shown may not be available, or may only be available in a different specification, or at a different price.

Design	Technology	GLS	Mercedes-AMG GLS	Mercedes-Maybach GLS	Model prices	Personalisation	Standard equipment	Genuine accessories	Technical data	Additional information
--------	------------	-----	------------------	----------------------	--------------	-----------------	--------------------	---------------------	----------------	------------------------



Book a test drive



Find your new GLS



Find a Showroom



GLS

Technology

[Design](#)

[Technology](#)

[GLS](#)

[Mercedes-AMG
GLS](#)

[Mercedes-Maybach
GLS](#)

[Model prices](#)

[Personalisation](#)

[Standard
equipment](#)

[Genuine
accessories](#)

[Technical data](#)

[Additional
information](#)



Book a test drive



Find your new GLS



Find a Showroom

Mercedes-Benz User Experience (MBUX)

Transforming the in-car user experience, thanks to MBUX: Controlled via voice or touch input, the innovative infotainment system can over time even predict personal habits thanks to artificial intelligence.

Multi-gesture touchpad control



MBUX multimedia system with DAB digital radio



Voice control

- Activated by the keywords “Hey Mercedes”, the new intelligent voice control LINGUATRONIC¹ lets you control many of the infotainment functions, including destination input, phone calls or music selection
- MBUX is able to understand different accents and will adjust to you over time
- MBUX even understands indirect commands. Feeling chilly? Just say “Hey Mercedes, I feel cold” and MBUX will adjust the temperature for you

Personalisation

- Turn the new GLS into your very own Mercedes-Benz by personalising driving modes, radio stations and much more
- Your personal settings can be saved in up to seven different profiles, making your driving experience the best one possible
- Thanks to artificial intelligence, MBUX is able to learn and adapt over time. It will be able to predict your personal habits, such as navigation for frequently-driven routes, or the radio station you like to listen to on your way home from work

Touch inputs

- Beside voice control you can operate MBUX via touchscreen, the touchpad on the centre console, as well as touch control buttons on the steering wheel
- The touchpad recognises your handwriting should you wish to enter addresses or phone numbers silently

Maintenance and service

- Wondering when the next service is due? Or how much further you can drive until you need to stop at a petrol station? Just ask your MBUX – it will tell you the answer

¹The connection of the communication module to the mobile phone network including the emergency call system depends on the respective network coverage and availability of network providers

¹LINGUATRONIC off-board functions are currently only available for three years

Design	Technology	GLS	Mercedes-AMG GLS	Mercedes-Maybach GLS	Model prices	Personalisation	Standard equipment	Genuine accessories	Technical data	Additional information
--------	------------	-----	------------------	----------------------	--------------	-----------------	--------------------	---------------------	----------------	------------------------

Driving Assistance package Plus

The **Driving Assistance package Plus¹** contains a range of highly intelligent features to help you stay safe on the road – by making the drive more effortless, by warning of danger, and by taking steps to protect you in an emergency.

Standard on all models.



Active Braking Assist with cross-traffic function can help to avoid accidents with vehicles ahead, crossing traffic and also pedestrians, and/or mitigate their consequences

Active Distance Assist DISTRONIC helps maintain the desired distance from the vehicle in front

Active Emergency Stop Assist: immediate emergency braking if evasion is impossible

Active Lane Keeping Assist

Active Speed Limit Assist ensures detected speed limits are automatically adopted as the set speed for Active Distance Assist DISTRONIC

Active Steering Assist: targeted steering intervention to prevent unintentional drifting out of lane

Active Stop-and-Go Assist

Blind Spot Assist can warn the driver of vehicles in the blind spot during a lane change

Evasive Steering Assist can support the driver in making evasive manoeuvres if, in a dangerous situation, he/she moves to avoid any pedestrian detected by the system

Pedestrian warning function near pedestrian crossings

Route-based speed adjustment: adaption of speed before curves, roundabouts and junctions

Traffic Sign Assist

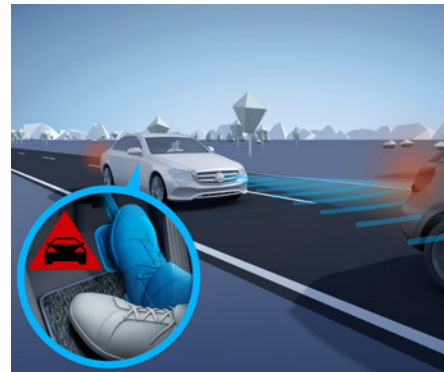

¹Our driver assistance and safety systems are aids and do not relieve you of your responsibility as the driver. Please take note of the information in the Owner's Manual and the system limits which are described therein

Design	Technology	GLS	Mercedes-AMG GLS	Mercedes-Maybach GLS	Model prices	Personalisation	Standard equipment	Genuine accessories	Technical data	Additional information
--------	------------	-----	------------------	----------------------	--------------	-----------------	--------------------	---------------------	----------------	------------------------

Digital Extras Stay connected any time, anywhere.

Digital Extras are a range of innovative online services designed to enhance your Mercedes-Benz experience. Accessible via mobile, tablet or PC, Digital Extras let you enjoy the highest standards of care and support, in a way that integrates seamlessly with your busy lifestyle.

Safety and Service – Digital Extras help to keep you and your car safe

Check your car's oil level, tyre pressure and fuel from your phone so you'll be ready for every journey.

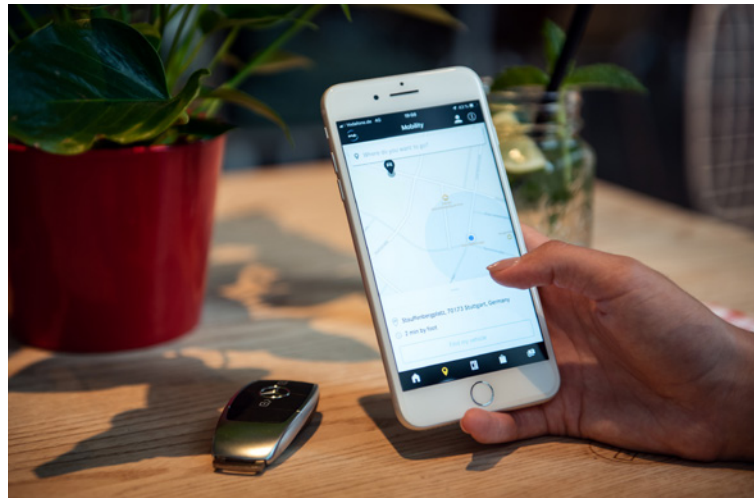

Live Traffic Information, Parked Vehicle Locator and much more

Forgot where you've parked? Parked Vehicle Locator¹ will show you exactly where your car is as long as you're in a 1-mile radius of where you parked. Real-time traffic data and dynamic route with shorter journey times.

For more information speak to your local Mercedes-Benz Agent or visit the Mercedes-Benz store at shop.mercedes-benz.com/en-gb/connect

Comfort – connect to your car anytime, anywhere

Forgot to lock your car? With Remote Car Lock² you will receive a notification on your smartphone to let you know. With one tap, you can lock and unlock your vehicle so you never have to worry.

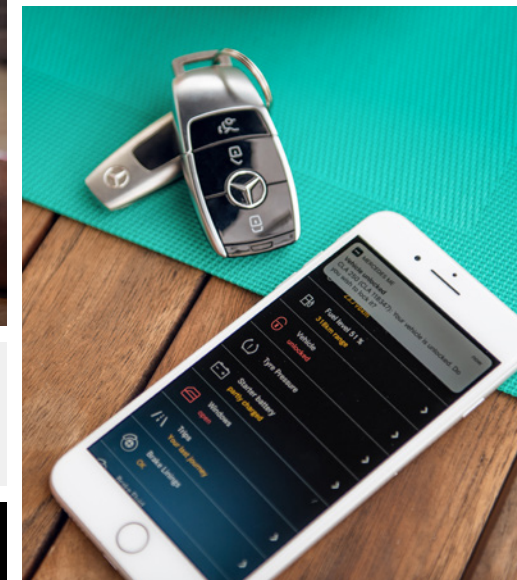

¹The connection of the communication module to the mobile phone network including the emergency call system depends on the respective network coverage and availability of network providers

²Available on all models with the Vehicle Monitoring package. This option may vary between standard and additional cost dependent on the model

³Part of the Vehicle Status package. This option may vary between standard and additional cost dependent on the model

Images shown are for illustration purposes only



Book a test drive



Find your new GLS



Find a Showroom

GLS Model lines overview



AMG Line Premium Plus »



Business Class »

Design	Technology	GLS	Mercedes-AMG GLS	Mercedes-Maybach GLS	Model prices	Personalisation	Standard equipment	Genuine accessories	Technical data	Additional information
--------	------------	-----	------------------	----------------------	--------------	-----------------	--------------------	---------------------	----------------	------------------------

AMG Line Premium Plus Standard equipment highlights



Option shown: sodalite blue metallic (code 842)



Option shown: sodalite blue metallic (code 842)

Exterior

22" AMG alloy wheels – multi-spoke design, painted high-gloss titanium grey with a high-shine finish (code RPA)

AIRMATIC air suspension with level adjustment and Adaptive Damping System

Aluminium-look illuminated running boards with rubber studs

AMG bodystyling – front apron, rear apron and side skirts

EASY-PACK powered tailgate

KEYLESS-GO Comfort package

MAGIC VISION CONTROL – adaptive windscreen wiper system, heated

MULTIBEAM LED headlights with Adaptive Highbeam Assist Plus

Panoramic glass sunroof

Privacy glass

Roof rails – chrome

Summer tyres



OTR from £107,500¹

¹The recommended on-the-road price includes the Road Fund Licence applicable to the standard model plus delivery charge (£730.00 incl. VAT), new vehicle registration fee (£55.00), fuel (£50.00 incl. VAT), and number plates (£25.00 incl. VAT). VAT is calculated at the standard rate of 20%. Some of the model features, optional extras and colours shown may not be available, or may only be available in a different specification, or at a different price

Design	Technology	GLS	Mercedes-AMG GLS	Mercedes-Maybach GLS	Model prices	Personalisation	Standard equipment	Genuine accessories	Technical data	Additional information
--------	------------	-----	------------------	----------------------	--------------	-----------------	--------------------	---------------------	----------------	------------------------



Interior

Ambient lighting – 64 colours

AMG floor mats with edging and embroidered 'AMG' lettering

Centre armrests – folding (rear)

Dashboard (upper and lower part) in ARTICO man-made leather

Fingerprint scanner

Memory package

Roof liner in black fabric

Seats – climatized (front)

Seats – heated (rear seats, second row)

Seats – multi-contour with massage function (front)

Seats – rear seats, third row (7 seats) – electrically folding and raising with EASY-ENTRY system power release

Steering wheel – 3-twin-spoke multifunction sports steering wheel in black nappa leather, with flattened bottom section, perforated grip area and touch control buttons

Temperature-controlled cup holder

THERMOTRONIC luxury automatic climate control

Warmth Comfort package

Safety, Communications and In-Car Entertainment

5G communications module¹

Burmester® surround sound system

DAB digital radio tuner

Driving Assistance package Plus²

Head-up display

Parking package with 360° camera

Pre-installation for MBUX Entertainment

Wireless charging³ (front)



Trim and Upholstery

Anthracite open-pore oak wood trim

Leather – black

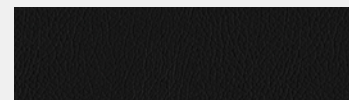
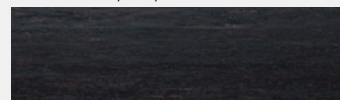

¹The connection of the communication module to the mobile phone network including the emergency call system depends on the respective network coverage and availability of network providers as described therein

²Our driver assistance and safety systems are aids and do not relieve you of your responsibility as the driver. Please take note of the information in the Owner's Manual and the system limits which

³Compatible mobile phone required

Business Class Standard equipment highlights



In addition to/replacement of AMG Line Premium Plus:

Exterior

23" AMG alloy wheels – 5-twin-spoke design, painted high-gloss black with a high-sheen finish (code RPQ)

Summer tyres



OTR from £117,500¹

¹The recommended on-the-road price includes the Road Fund Licence applicable to the standard model plus delivery charge (£730.00 incl. VAT), new vehicle registration fee (£55.00), fuel (£50.00 incl. VAT), and number plates (£25.00 incl. VAT). VAT is calculated at the standard rate of 20%. Some of the model features, optional extras and colours shown may not be available, or may only be available in a different specification, or at a different price

Design	Technology	GLS	Mercedes-AMG GLS	Mercedes-Maybach GLS	Model prices	Personalisation	Standard equipment	Genuine accessories	Technical data	Additional information
--------	------------	-----	------------------	----------------------	--------------	-----------------	--------------------	---------------------	----------------	------------------------



Interior

Rear Comfort package

Seats – climatised (rear seats, second row)

Seats – heated (rear seats, third row)

Seats – luxury rear head rests (outer seats)

Seats – multi-contour with massage functions (rear seats, second row)

Seats – seat on front passenger side electrically adjustable from the rear

Steering wheel – heated

Sun blinds – electrically operated sun blinds in the rear side windows

Safety, Communications and In-Car Entertainment

MBUX High-End Rear Seat Entertainment System

MBUX rear tablet

Two wireless head sets

Wireless charging¹ (rear)

¹Compatible mobile phone required

Trim and Upholstery

Anthracite open-pore oak wood trim

Leather – black



Book a test drive



Find your new GLS



Find a Showroom



AMG



GLS

Mercedes-AMG

Design	Technology	GLS	Mercedes-AMG GLS	Mercedes-Maybach GLS	Model prices	Personalisation	Standard equipment	Genuine accessories	Technical data	Additional information
--------	------------	-----	------------------	----------------------	--------------	-----------------	--------------------	---------------------	----------------	------------------------

Mercedes-AMG GLS 63 4MATIC+ Night Edition Standard equipment highlights



No-cost option shown: high-tech silver metallic (code 922)



No-cost option shown: high-tech silver metallic (code 922)



Engine, Transmission and Suspension

- AMG Active Ride Control+
- AMG electronic rear-axle limited-slip differential
- Selectable AMG Performance exhaust system

Exterior

- 23" AMG forged wheels – multi-spoke design, painted matt black with a high-sheen rim flange (code RXY)
- AMG emblem
- AMG high-performance composite braking system
- Red-painted brake callipers with 'AMG' lettering
- Roof rails in black
- Summer tyres

OTR from **£153,595¹**

¹The recommended on-the-road price includes the Road Fund Licence applicable to the standard model plus delivery charge (£730.00 incl. VAT), new vehicle registration fee (£55.00), fuel (£50.00 incl. VAT), and number plates (£25.00 incl. VAT). VAT is calculated at the standard rate of 20%. Some of the model features, optional extras and colours shown may not be available, or may only be available in a different specification, or at a different price

Design	Technology	GLS	Mercedes-AMG GLS	Mercedes-Maybach GLS	Model prices	Personalisation	Standard equipment	Genuine accessories	Technical data	Additional information
--------	------------	-----	------------------	----------------------	--------------	-----------------	--------------------	---------------------	----------------	------------------------



Safety, Communications and In-Car Entertainment

- AMG Track Pace
- Driving Assistance package Plus¹
- MBUX High-End Rear Seat Entertainment System
- Wireless charging² for mobile phones (front and rear)



Front door sill panels with 'AMG' lettering, illuminated in white

Interior

- AMG Performance steering wheel in carbon fibre/DINAMICA microfibre and AMG steering wheel buttons
- Climatised multi-contour rear seats with massage functions
- Door sills – front door sill panels with 'AMG' lettering, illuminated in white

- Fingerprint scanner
- Seat on front passenger side, electrically adjustable from the rear
- Steering wheel – heated
- Temperature-controlled cup holder for driver and front passenger

Trim and Upholstery

- AMG carbon fibre trim
- AMG Style Exclusive nappa leather – black



¹Our driver assistance and safety systems are aids and do not relieve you of your responsibility as the driver. Please take note of the information in the Owner's Manual and the system limits which are described therein ²Compatible mobile phone required

Design	Technology	GLS	Mercedes-AMG GLS	Mercedes-Maybach GLS	Model prices	Personalisation	Standard equipment	Genuine accessories	Technical data	Additional information
--------	------------	-----	------------------	----------------------	--------------	-----------------	--------------------	---------------------	----------------	------------------------



Book a test drive



Find your new GLS



Find a Showroom

Become the AMG expert

Unleash a new level of performance.



Step into the world of performance and experience the AMG brand at Mercedes-Benz World – from the powerful sound of the engines to the smell of the leather to the unmistakable design of our vehicles.

Mercedes-Benz World invites all Mercedes-AMG customers to a complimentary adrenaline-packed driving experience. Feel the sensational AMG driving performance, develop your driving skills and even try your hand at power-sliding on the Wet Skid Circle. With expert one-to-one guidance from a Driving Specialist in the passenger seat, experience every inch of our Handling Circuits, Dynamic Straight and low friction surfaces.

[Click here for more information](#)



TERMS AND CONDITIONS

The following customers only are eligible: The first purchaser/registered keeper of a newly registered Mercedes-AMG. The complimentary training must be booked and taken within 12 months of email receipt. The training is available Monday - Friday only (excluding bank holidays) and subject to availability. Upgrades are available for an additional cost, details upon request. Transferable to individuals who reside at the same postal address only. Mercedes-Benz UK Limited reserves the right to amend or withdraw this training experience. Attendees must hold a full UK driving licence. Attendees will be required to sign the Mercedes-Benz World Driving Risk Acknowledgement prior to undertaking the training experience.

The training experience is also subject to the Mercedes-Benz World Terms and Conditions, as applicable. Retailer demonstrator vehicles are not eligible.

Design	Technology	GLS	Mercedes-AMG GLS	Mercedes-Maybach GLS	Model prices	Personalisation	Standard equipment	Genuine accessories	Technical data	Additional information
--------	------------	-----	------------------	----------------------	--------------	-----------------	--------------------	---------------------	----------------	------------------------



Book a test drive



Find your new GLS



Find a Showroom

GLS

Mercedes-Maybach



Design	Technology	GLS	Mercedes-AMG GLS	Mercedes-Maybach GLS	Model prices	Personalisation	Standard equipment	Genuine accessories	Technical data	Additional information
--------	------------	-----	------------------	----------------------	--------------	-----------------	--------------------	---------------------	----------------	------------------------



Book a test drive



Find your new GLS



Find a Showroom

Mercedes-Maybach GLS Model lines overview

MAYBACH

Mercedes-Maybach GLS 600 4MATIC »



Mercedes-Maybach GLS 600 4MATIC Night Series »



Mercedes-Maybach GLS 600 4MATIC First Class



Mercedes-Maybach GLS 600 4MATIC First Class Night Series »



Design

Technology

GLS

Mercedes-AMG
GLS

Mercedes-Maybach
GLS

Model prices

Personalisation

Standard
equipment

Genuine
accessories

Technical data

Additional
information

Mercedes-Maybach GLS 600 4MATIC Standard equipment highlights

MAYBACH



Exterior

22" Maybach light-alloy wheels – multi-spoke design in high-gloss black with a high-shine finish, including fully integrated wheel bolt cover (code R63)

Air inlet grilles feature a Maybach pattern

AIRMATIC air suspension with level adjustment and Adaptive Damping System

MAGIC VISION CONTROL

Maybach electrically extending running boards

Maybach-specific tailpipe trim, in a high-gloss chrome finish with horizontal trim inserts

Panoramic glass sunroof

Summer tyres

Towing package



OTR from **£177,595¹**

¹The recommended on-the-road price includes the Road Fund Licence applicable to the standard model plus delivery charge (£730.00 incl. VAT), new vehicle registration fee (£55.00), fuel (£50.00 incl. VAT), and number plates (£25.00 incl. VAT). VAT is calculated at the standard rate of 20%. Some of the model features, optional extras and colours shown may not be available, or may only be available in a different specification, or at a different price

Design	Technology	GLS	Mercedes-AMG GLS	Mercedes-Maybach GLS	Model prices	Personalisation	Standard equipment	Genuine accessories	Technical data	Additional information
--------	------------	-----	------------------	----------------------	--------------	-----------------	--------------------	---------------------	----------------	------------------------



Interior

- AIR BALANCE package
- Door sills with 'Maybach' lettering
- Electric sunblinds in rear doors, left and right
- ENERGIZING Plus package
- Fingerprint scanner
- Heated wood-leather multifunction steering wheel

- Memory package
- Multicontour, climatised front and rear seats with massage function
- Pedal assembly in brushed stainless steel with Maybach emblem
- THERMOTRONIC luxury automatic climate control
- Warmth Comfort package

Communications and In-Car Entertainment

- Burmester® surround sound system
- Head-up display
- MBUX High-End Rear Seat Entertainment system
- MBUX rear tablet
- Smartphone integration¹ including Apple CarPlay® and Android Auto™

- Widescreen cockpit comprising two displays, each with a 12.3-inch screen diagonal and a specific 'Maybach' display style
- Wireless charging¹ (front and rear)
- Wireless headsets (2)



Panoramic glass sunroof

Safety and Assistance Systems

- Driving Assistance package Plus²
- Parking package with 360° camera

- GUARD 360° vehicle protection Plus³

Trim and Upholstery

- MANUFAKTUR high-gloss black flowing lines piano lacquer

- Exclusive nappa leather – black



¹Compatible mobile phone required ²Our driver assistance and safety systems are aids and do not relieve you of your responsibility as the driver. Please take note of the information in the Owner's Manual and the system limits which are described therein

³The connection of the communication module to the mobile phone network including the emergency call system depends on the respective network coverage and availability of network providers

Mercedes-Maybach GLS 600 4MATIC Night Series Standard equipment highlights

MAYBACH



Option shown: obsidian black/mojave silver metallic (code C10)

OTR from £203,595¹



Option shown: obsidian black/mojave silver metallic (code C10)

In addition to/replacement of Mercedes-Maybach GLS 600 4MATIC:

Exterior

23" Maybach light alloy wheels – 7-spoke design, bichromatic finish in black/dark shadow gloss with aero elements in a Mercedes-Maybach look, including fully integrated wheel bolt cover (code 85R)

Electrically retractable and illuminated running board with Maybach emblem in high-gloss black

Exclusive exterior design elements in dark shadow gloss

MULTIBEAM LED pins in rosé gold with Maybach emblems

Roof rails in matt black

Summer tyres



¹The recommended on-the-road price includes the Road Fund Licence applicable to the standard model plus delivery charge (£730.00 incl. VAT), new vehicle registration fee (£55.00), fuel (£50.00 incl. VAT), and number plates (£25.00 incl. VAT). VAT is calculated at the standard rate of 20%. Some of the model features, optional extras and colours shown may not be available, or may only be available in a different specification, or at a different price

Design	Technology	GLS	Mercedes-AMG GLS	Mercedes-Maybach GLS	Model prices	Personalisation	Standard equipment	Genuine accessories	Technical data	Additional information
--------	------------	-----	------------------	----------------------	--------------	-----------------	--------------------	---------------------	----------------	------------------------

**Interior**

Door sills with 'Maybach Night Series' lettering

'Garnet Glow' ambient lighting colour scheme

Maybach emblems in dark shadow gloss

Vehicle key in high-gloss black with ornamental frame in dark shadow gloss

Communications and In-Car Entertainment

Night Series start-up animation on the media display

Trim and Upholstery

MANUFAKTUR open-pore dark brown fishbone pattern walnut wood

Exclusive nappa leather – pearl black

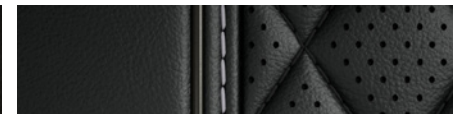
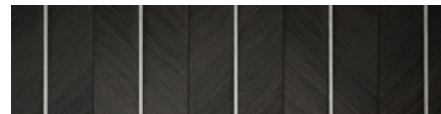

Design	Technology	GLS	Mercedes-AMG GLS	Mercedes-Maybach GLS	Model prices	Personalisation	Standard equipment	Genuine accessories	Technical data	Additional information
--------	------------	-----	------------------	----------------------	--------------	-----------------	--------------------	---------------------	----------------	------------------------

Mercedes-Maybach GLS 600 4MATIC First Class Standard equipment highlights

MAYBACH



No-cost option shown: high-tech silver metallic (code 922)



No-cost option shown: high-tech silver metallic (code 922)

Exterior

22" Maybach light-alloy wheels – multi-spoke design in high-gloss black with a high-shine finish, including fully integrated wheel bolt cover (code R63)

E-ACTIVE BODY CONTROL suspension

Summer tyres

OTR from **£181,895¹**

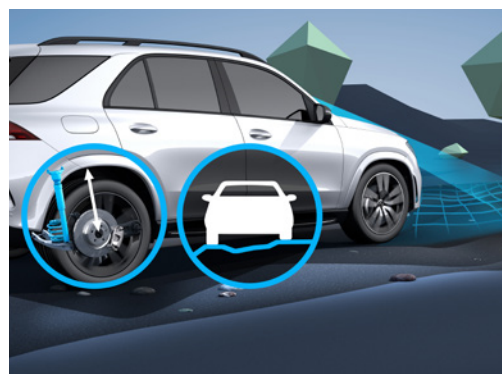

¹The recommended on-the-road price includes the Road Fund Licence applicable to the standard model plus delivery charge (£730.00 incl. VAT), new vehicle registration fee (£55.00), fuel (£50.00 incl. VAT), and number plates (£25.00 incl. VAT). VAT is calculated at the standard rate of 20%. Some of the model features, optional extras and colours shown may not be available, or may only be available in a different specification, or at a different price

Design	Technology	GLS	Mercedes-AMG GLS	Mercedes-Maybach GLS	Model prices	Personalisation	Standard equipment	Genuine accessories	Technical data	Additional information
--------	------------	-----	------------------	----------------------	--------------	-----------------	--------------------	---------------------	----------------	------------------------

Option shown: Exclusive nappa leather in MANUFAKTUR crystal white/silvergrey pearl (code 519A)



Interior

Door sills with 'Maybach' lettering

Folding rear tables

High pile floor mats

Holder for two champagne flutes¹

Individual luxury rear seats (2)

Refrigerated compartment in the rear

Communications and In-Car Entertainment

Burmester® high-end 3D surround sound

Trim and Upholstery

MANUFAKTUR high-gloss black flowing lines piano lacquer

Exclusive nappa leather – black

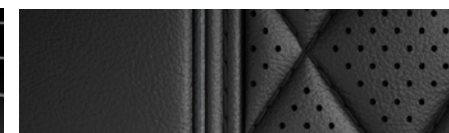

¹Champagne flutes are sold separately via Mercedes-Benz Genuine Accessories

Design	Technology	GLS	Mercedes-AMG GLS	Mercedes-Maybach GLS	Model prices	Personalisation	Standard equipment	Genuine accessories	Technical data	Additional information
--------	------------	-----	------------------	----------------------	--------------	-----------------	--------------------	---------------------	----------------	------------------------

Mercedes-Maybach GLS 600 4MATIC First Class Night Series

Std. equip. highlights

MAYBACH



Option shown: MANUFAKTUR opalite white (code 885)



Option shown: MANUFAKTUR opalite white (code 885)

In addition to/replacement of Mercedes-Maybach GLS 600 4MATIC First Class:

Exterior

23" Maybach light alloy wheels – 7-spoke design, bichromatic finish in black/dark shadow gloss with aero elements in a Mercedes-Maybach look, including fully integrated wheel bolt cover (code 85R)

Electrically retractable and illuminated running board with Maybach emblem in high-gloss black

Exclusive exterior design elements in dark shadow gloss
MULTIBEAM LED pins in rosé gold with Maybach emblems

Roof rails in matt black

Summer tyres



OTR from **£207,895¹**

¹The recommended on-the-road price includes the Road Fund Licence applicable to the standard model plus delivery charge (£730.00 incl. VAT), new vehicle registration fee (£55.00), fuel (£50.00 incl. VAT), and number plates (£25.00 incl. VAT). VAT is calculated at the standard rate of 20%. Some of the model features, optional extras and colours shown may not be available, or may only be available in a different specification, or at a different price

Design	Technology	GLS	Mercedes-AMG GLS	Mercedes-Maybach GLS	Model prices	Personalisation	Standard equipment	Genuine accessories	Technical data	Additional information
--------	------------	-----	------------------	----------------------	--------------	-----------------	--------------------	---------------------	----------------	------------------------



Interior

Door sills with 'Maybach Night Series' lettering
'Garnet Glow' ambient lighting colour scheme

Maybach emblems in dark shadow gloss

Vehicle key in high-gloss black with ornamental frame in dark shadow gloss

Trim and Upholstery

MANUFAKTUR open-pore dark brown fishbone pattern walnut wood

Exclusive nappa leather – pearl black

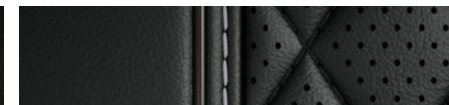
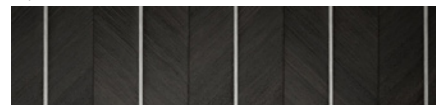

[Book a test drive](#)[Find your new GLS](#)[Find a Showroom](#)

Model prices

VED and BIK applicable for registrations up to 31 March 2025

Model line	Engine	Transmission	CO ₂ WLTP ^{1,*}	Basic RRP excl. VAT (£)	Total RRP incl. VAT (£)	Road Fund Licence (£) ² WLTP	Rec. OTR price (£) ³ WLTP	P11D value (£)	BIK tax rate 2024/25 (%) ²
AMG Line Premium Plus									
GLS 450 d 4MATIC	Diesel – 2,989 cc, 6-cylinder, 367 hp/270 kW	9G-TRONIC 9-speed auto.	217	87,500.00	105,000.00	1,640.00	107,500.00	105,805.00	37
GLS 450 4MATIC	Petrol – 2,999 cc, 6-cylinder, 381 hp/280 kW	9G-TRONIC 9-speed auto.	241	89,166.67	107,000.00	2,330.00	110,190.00	107,805.00	37
Business Class									
GLS 450 d 4MATIC	Diesel – 2,989 cc, 6-cylinder, 367 hp/270 kW	9G-TRONIC 9-speed auto.	221	95,833.33	115,000.00	1,640.00	117,500.00	115,805.00	37
GLS 450 4MATIC	Petrol – 2,999 cc, 6-cylinder, 381 hp/280 kW	9G-TRONIC 9-speed auto.	245	97,500.00	117,000.00	2,330.00	120,190.00	117,805.00	37
Mercedes-AMG Night Edition									
GLS 63 4MATIC+	Petrol – 3,982 cc, 8-cylinder, 612 hp/450 kW Mild hybrid drive – 22 hp/16 kW	AMG SPEEDSHIFT TCT 9-speed auto.	303	125,000.00	150,000.00	2,735.00	153,595.00	150,805.00	37
Mercedes-Maybach									
GLS 600 4MATIC	Petrol – 3,982 cc, 8-cylinder, 557 hp/410 kW Mild hybrid drive – 22 hp/16 kW	9G-TRONIC 9-speed auto.	313	145,000.00	174,000.00	2,735.00	177,595.00	174,805.00	37
GLS 600 4MATIC Night Series	Petrol – 3,982, 8-cylinder, 557 hp/410 kW Mild hybrid drive – 22 hp/16 kW	9G-TRONIC 9-speed auto.	313	166,666.67	200,000.00	2,735.00	203,595.00	200,805.00	37
Mercedes-Maybach First Class									
GLS 600 4MATIC	Petrol – 3,982 cc, 8-cylinder, 557 hp/410 kW Mild hybrid drive – 22 hp/16 kW	9G-TRONIC 9-speed auto.	315	148,583.33	178,300.00	2,735.00	181,895.00	179,105.00	37
GLS 600 4MATIC Night Series	Petrol – 3,982, 8-cylinder, 557 hp/410 kW Mild hybrid drive – 22 hp/16 kW	9G-TRONIC 9-speed auto.	315	170,250.00	204,300.00	2,735.00	207,895.00	205,105.00	37

¹The indicated values were determined according to the prescribed measurement method - Worldwide Harmonised Light Vehicle Test Procedure (WLTP). Figures shown may include options which are not available in the UK. ²Figures shown are for comparability purposes; only compare with other cars tested to the same technical procedures. Figures may not reflect real life driving results, which will depend upon a number of factors including factory-fitted options, accessories fitted (post registration), variations in weather, driving styles and vehicle load. Further information about the test used to establish fuel consumption and CO₂ figures can be found at <http://www.mercedes-benz.co.uk/WLTP> ³A different first year rate of Vehicle Excise Duty (Road Fund Licence) applies for new cars. Please refer to page 65 for the relevant rate for the second and subsequent years. ⁴The recommended on-the-road price includes the Road Fund Licence applicable to the standard model plus delivery charge (£730.00 incl. VAT), new vehicle registration fee (£55.00), fuel (£50.00 incl. VAT), and number plates (£25.00 incl. VAT). VAT is calculated at the standard rate of 20%. Some of the model features, optional extras and colours shown may not be available, or may only be available in a different specification, or at a different price



Book a test drive



Find your new GLS



Find a Showroom

Personalisation Overview



Trims »



Paints »



Wheels »



Upholstery »



Packages »

Design

Technology

GLS

Mercedes-AMG
GLS

Mercedes-Maybach
GLS

Model prices

Personalisation

Standard
equipment

Genuine
accessories

Technical data

Additional
information

Trim

● Standard □ No-cost option ○ Optional - Not available



H31 Anthracite open-pore oak wood trim

AMG Line Premium Plus	●
Business Class	●
Mercedes-Maybach	□
Mercedes-Maybach Night Series	-
Mercedes-Maybach First Class	□
Mercedes-Maybach First Class Night Series	-
Total RRP incl. VAT	-



H11 MANUFAKTUR high-gloss black flowing lines piano lacquer trim

AMG Line Premium Plus	-
Business Class	-
Mercedes-Maybach	●
Mercedes-Maybach Night Series	-
Mercedes-Maybach First Class	●
Mercedes-Maybach First Class Night Series	-
Total RRP incl. VAT	-



16H MANUFAKTUR open-pore dark brown fishbone pattern walnut wood

AMG Line Premium Plus	-
Business Class	-
Mercedes-Maybach	-
Mercedes-Maybach Night Series	●
Mercedes-Maybach First Class	-
Mercedes-Maybach First Class Night Series	●
Total RRP incl. VAT	-



H22 Brown open-pore walnut wood trim

AMG Line Premium Plus	○
Business Class	○
Mercedes-Maybach	□
Mercedes-Maybach Night Series	-
Mercedes-Maybach First Class	□
Mercedes-Maybach First Class Night Series	-
Total RRP incl. VAT	£165.00

Upholstery GLS

● Standard □ No-cost option - Not available



201A Leather¹ – black

AMG Line Premium Plus	●
Business Class	●
Total RRP incl. VAT	-



215A Leather¹ – macchiato beige/black

AMG Line Premium Plus	□
Business Class	□
Total RRP incl. VAT	-



224A Leather¹ – bahia brown/black

AMG Line Premium Plus	□
Business Class	□
Total RRP incl. VAT	-

¹At least 80% of the seat upholstery is pure leather, while up to 20% may consist of man-made leather

Upholstery GLS

No-cost option Optional



225A Leather¹ – macara beige/black

AMG Line Premium Plus	<input type="checkbox"/>
Business Class	<input type="checkbox"/>
Total RRP incl. VAT	-



951A Nappa leather² – black

AMG Line Premium Plus	<input type="radio"/>
Business Class	<input type="radio"/>
Total RRP incl. VAT	£3,500.00

¹At least 80% of the seat upholstery is pure leather, while up to 20% may consist of man-made leather

²100% of seat upholstery is pure leather

[Book a test drive](#)[Find your new GLS](#)[Find a Showroom](#)

Upholstery Mercedes-AMG GLS

Standard No-cost option



561A AMG Style Exclusive nappa leather¹ – black

Mercedes-AMG GLS 63 4MATIC+ Night Edition



Total RRP incl. VAT

-



565A AMG Style Exclusive nappa leather¹ – macchiato beige/black

Mercedes-AMG GLS 63 4MATIC+ Night Edition



Total RRP incl. VAT

-



551A AMG Exclusive nappa leather¹ – black

Mercedes-AMG GLS 63 4MATIC+ Night Edition



Total RRP incl. VAT

-

¹100% of seat upholstery is pure leather

Design	Technology	GLS	Mercedes-AMG GLS	Mercedes-Maybach GLS	Model prices	Personalisation	Standard equipment	Genuine accessories	Technical data	Additional information
--------	------------	-----	------------------	----------------------	--------------	-----------------	--------------------	---------------------	----------------	------------------------

Upholstery Mercedes-AMG GLS

No-cost option



555A AMG Exclusive nappa leather¹ – two-tone macchiato beige/black

Mercedes-AMG GLS 63 4MATIC+ Night Edition



Total RRP incl. VAT

-



574A AMG Exclusive nappa leather¹ – two-tone bahia brown/black

Mercedes-AMG GLS 63 4MATIC+ Night Edition



Total RRP incl. VAT

-

¹100% of seat upholstery is pure leather

Upholstery Mercedes-Maybach GLS

● Standard □ No-cost option - Not available



511A Exclusive nappa leather¹ - black

Mercedes-Maybach GLS 600 4MATIC	●
Mercedes-Maybach GLS 600 4MATIC Night Series	-
Mercedes-Maybach GLS 600 4MATIC First Class	●
Mercedes-Maybach GLS 600 4MATIC First Class Night Series	-
Total RRP incl. VAT	-



514A Exclusive nappa leather¹ - two-tone MANUFaktur mahogany brown/macchiato beige

Mercedes-Maybach GLS 600 4MATIC	□
Mercedes-Maybach GLS 600 4MATIC Night Series	-
Mercedes-Maybach GLS 600 4MATIC First Class	□
Mercedes-Maybach GLS 600 4MATIC First Class Night Series	-
Total RRP incl. VAT	-

¹100% of seat upholstery is pure leather

²Only available with the optional MANUFaktur Leather package (code U61)

Upholstery Mercedes-Maybach GLS

No-cost option Optional



519A Exclusive nappa leather¹ – two-tone MANUFAKTUR crystal white/silver grey pear²

Mercedes-Maybach GLS 600 4MATIC	<input type="radio"/>
Mercedes-Maybach GLS 600 4MATIC Night Series	–
Mercedes-Maybach GLS 600 4MATIC First Class	<input type="radio"/>
Mercedes-Maybach GLS 600 4MATIC First Class Night Series	–
Total RRP incl. VAT	£20,895.00



521A Exclusive nappa leather¹ – pearl black

Mercedes-Maybach GLS 600 4MATIC	–
Mercedes-Maybach GLS 600 4MATIC Night Series	●
Mercedes-Maybach GLS 600 4MATIC First Class	–
Mercedes-Maybach GLS 600 4MATIC First Class Night Series	●
Total RRP incl. VAT	–

¹100% of seat upholstery is pure leather ²Only available with the optional MANUFAKTUR Leather package (code U61)

Colour options

● Standard □ No-cost option ○ Optional – Not available



197 obsidian black metallic

AMG Line Premium Plus/Business Class	●
Mercedes-AMG model	●
Mercedes-Maybach models	●
Mercedes-Maybach Night Series models	●
Total RRP incl. VAT	-



922 high-tech silver metallic

AMG Line Premium Plus/Business Class	□
Mercedes-AMG model	□
Mercedes-Maybach models	□
Mercedes-Maybach Night Series models	-
Total RRP incl. VAT	-



885 MANUFAKTUR opalite white

AMG Line Premium Plus/Business Class	○
Mercedes-AMG model	○
Mercedes-Maybach models	○
Mercedes-Maybach Night Series models	○
Total RRP incl. VAT	£920.00



956 MANUFAKTUR alpine grey

AMG Line Premium Plus/Business Class	○
Mercedes-AMG model	○
Mercedes-Maybach models	○
Mercedes-Maybach Night Series models	-
Total RRP incl. VAT	£2,900.00



842 sodalite blue metallic

AMG Line Premium Plus/Business Class	□
Mercedes-AMG model	□
Mercedes-Maybach models	□
Mercedes-Maybach Night Series models	-
Total RRP incl. VAT	-



992 selenite grey metallic

AMG Line Premium Plus/Business Class	□
Mercedes-AMG model	□
Mercedes-Maybach models	□
Mercedes-Maybach Night Series models	-
Total RRP incl. VAT	-



996 MANUFAKTUR hyacinth red metallic

AMG Line Premium Plus/Business Class	○
Mercedes-AMG model	○
Mercedes-Maybach models	○
Mercedes-Maybach Night Series models	-
Total RRP incl. VAT	£920.00

Please note that, owing to limitations of on-screen representation, paint colours may differ from those shown

Colour options Mercedes-Maybach GLS (two-tone paints)

○ Optional – Not available



C10 obsidian black/mojave silver metallic	
Mercedes-Maybach models	–
Mercedes-Maybach Night Series models	○
Total RRP incl. VAT	£18,095.00



C21 obsidian black/rubellite red metallic	
Mercedes-Maybach models	○
Mercedes-Maybach Night Series models	–
Total RRP incl. VAT	£18,095.00



C35 high-tech silver/obsidian black metallic	
Mercedes-Maybach models	○
Mercedes-Maybach Night Series models	–
Total RRP incl. VAT	£18,095.00



C20 high-tech silver/nautic blue metallic	
Mercedes-Maybach models	○
Mercedes-Maybach Night Series models	–
Total RRP incl. VAT	£18,095.00



C23 obsidian black/MANUFAKTUR kalahari gold metallic	
Mercedes-Maybach models	○
Mercedes-Maybach Night Series models	–
Total RRP incl. VAT	£18,095.00

Please note that, owing to limitations of on-screen representation, paint colours may differ from those shown

Wheels GLS

● Standard ○ Optional - Not available



RPA 22" AMG alloy wheels - multi-spoke design, painted high-gloss titanium grey with a high-sheen finish, with 285/45 (front) and 325/40 (rear) R 22 tyres

AMG Line Premium Plus	●
Business Class	-
Total RRP incl. VAT	-



RPB 22" AMG alloy wheels - multi-spoke design, painted high-gloss black with a high-sheen finish, 285/45 (front) R 20 tyres and 325/40 (rear) R 22 tyres

AMG Line Premium Plus	○
Business Class	-
Total RRP incl. VAT	£350.00



RPQ 23" AMG alloy wheels - 5-twin-spoke design, painted high-gloss black with a high-sheen finish, with 285/40 (front) and 325/35 (rear) R 23 tyres

AMG Line Premium Plus	-
Business Class	●
Total RRP incl. VAT	-



RPK 23" AMG alloy wheels - 5-twin-spoke design, painted high-gloss black with a high-sheen finish, 285/40 (front) and 325/35 (rear) R 23 tyres

AMG Line Premium Plus	-
Business Class	○
Total RRP incl. VAT	£350.00

Wheels Mercedes-AMG GLS

● Standard □ No-cost option - Not available



RXY 23" AMG alloy wheels - multi-spoke design, painted matt black with a high-shine rim flange, 285/40 (front) and 325/35 (rear) R 23 tyres

Mercedes-AMG model	●
Total RRP incl. VAT	-



RXX 23" AMG forged wheels - multi-spoke design, painted himalayas grey with a high-shine finish, with 285/40 (front) and 325/35 (rear) R 23 tyres

Mercedes-AMG model	□
Total RRP incl. VAT	-

[Book a test drive](#)[Find your new GLS](#)[Find a Showroom](#)

Wheels Mercedes-Maybach GLS

● Standard ○ Optional - Not available



R63 22" Maybach light-alloy wheels - multi-spoke design, painted high-gloss black with a high-shine finish, including fully integrated wheel bolt cover, 285/45 (front) and 325/40 (rear) R22 tyres

Mercedes-Maybach models	●
Mercedes-Maybach Night Series models	-
Total RRP incl. VAT	-



R65 23" Maybach alloy wheels - multi-spoke design, polished ceramic, including fully integrated wheel bolt cover, 285/40 (front) and 325/35 (rear) R23 tyres

Mercedes-Maybach models	○
Mercedes-Maybach Night Series models	-
Total RRP incl. VAT	£6,400.00



R85R 23" Maybach alloy wheels - multi-spoke design, polished ceramic, including fully integrated wheel bolt cover, 285/40 (front) and 325/35 (rear) R23 tyres

Mercedes-Maybach models	-
Mercedes-Maybach Night Series models	●
Total RRP incl. VAT	-



MANUFAKTUR Leather package

The MANUFAKTUR Leather package enhances the exciting Maybach aesthetics of the interior with exquisite materials.

MANUFAKTUR Leather package (code U61) – designed and priced as a package, including items as listed.

Only available for Mercedes-Maybach models¹

Total incl. VAT £13,650.00

Consisting of:

Front seat console on driver and front passenger sides in nappa leather

MANUFAKTUR roof liner in nappa leather with topstitching including leather-covered sun visors, grab handles, map pockets, and pillars

Two upholstered cushions with 'Maybach' logo

Two upholstered cushions for the leg rests of the Executive seats

Window frame lining in the boot cover in ARTICO man-made leather



Option shown: Exclusive nappa leather in MANUFAKTUR crystal white/silver grey pearl (code 519A)



¹Not available on Mercedes-Maybach Night Series models

Towing package

● Standard ○ Optional – Not available

The Towing package offers an electronically folding tow bar which increases the towing capacity up to 3,500 kg.

Designed and priced as a package, including items listed below.

Model line	Towing package (code DP8)
AMG Line Premium Plus/Business Class	○
Mercedes-AMG model	○
Mercedes-Maybach models	●
Mercedes-Maybach Night Series models	–
Total incl. VAT	£1,500.00

Consisting of:

Electronically folding tow bar
(includes 13-pin socket; ESC: Electronic
Stability Control)

Increased towing capacity – max. 3,500 kg



[Book a test drive](#)[Find your new GLS](#)[Find a Showroom](#)

Standard equipment

● Standard – Not available

Engine, Transmission and Suspension

	AMG Line Premium Plus	GLS 63 4MATIC+ Night Edition Business Class	GLS 63 4MATIC+ Night Edition Business Class
AMG Driver's package – increased top speed (174 mph)	–	–	●
AMG electronic rear-axle limited-slip differential	–	–	●
AMG Performance exhaust system, selectable	–	–	●
DYNAMIC SELECT with a choice of driving modes: 'Eco', 'Comfort', 'Sport' and 'Individual'	●	●	–
DYNAMIC SELECT with a choice of driving modes: 'Sport', 'Sport+', 'Trail', 'Sand', 'Slippery', 'Individual' and 'Manual'	–	–	●
ECO start/stop function	●	●	●
EQ Boost starter-alternator	●	●	●
Four-wheel drive	●	●	●
Suspension – AIRMATIC air suspension with level adjustment and Adaptive Damping System	●	●	–
Suspension – AMG RIDE CONTROL+ air suspension with level adjustment and Adaptive Damping System	–	–	●
Transmission – 9G-TRONIC 9-speed automatic transmission with steering column gear selector, steering wheel gearshift paddles (Direct Select)	●	●	–
Transmission – AMG SPEEDSHIFT TCT 9G 9-speed automatic transmission with steering column gear selector and steering wheel gearshift paddles (Direct Select)	–	–	●

Steering

Direct Steering	●	●	●
Steering column – electrically adjustable with EASY-ENTRY function	●	●	●
Steering wheel – 3-twin-spoke multifunction sports steering wheel in nappa leather black, with flattened bottom section, perforated grip area and touch control buttons	●	●	–
Steering wheel – AMG Performance steering wheel in carbon fibre/DINAMICA microfibre with AMG steering wheel buttons	–	–	●
Steering wheel – heated	–	●	●

Exterior

	AMG Line Premium Plus	GLS 63 4MATIC+ Night Edition Business Class	GLS 63 4MATIC+ Night Edition Business Class
AMG bodystyling – front apron, rear apron and side skirts	●	●	●
Diesel Particulate Filter (GLS 450 d 4MATIC only)	●	●	–
EASY-PACK powered tailgate – the EASY-PACK boot lid can be opened and closed at the touch of a button for more convenient loading and unloading of the boot	●	●	●
KEYLESS-GO Comfort package – the vehicle can be conveniently unlocked, started and locked – simply by carrying the electronic key	●	●	●
Lights – Headlight Assist: automatic headlight activation	●	●	●
Lights – LED tail lights	●	●	●
Lights – MULTIBEAM LED with Adaptive Highbeam Assist Plus	●	●	●
MAGIC VISION CONTROL – adaptive windscreen wiper system, heated	●	●	●
Mirror package – including projection of Mercedes-Benz logo integrated into both mirrors – including heated exterior mirrors, automatically-dimming rear view mirror and exterior mirror on driver's side and electrically-folding exterior mirrors left and right	●	●	●
Panoramic glass sunroof – consists of a fixed panoramic glass sunroof above the second seat row, and an electrically-operated sliding glass front section with an electrically-operated interior sun blind	●	●	●
Petrol Particulate Filter (excluding GLS 450 4MATIC)	●	●	–
Power closing aid for doors and boot lid – power closing ensures smooth and virtually silent closing. Once they have initially engaged, the front and rear doors are automatically drawn closed by servomotors	●	●	●
Privacy glass – heat-insulating tinted glass from B-pillar backwards	●	●	●
Rain-sensing wipers	●	●	●
Roof rails – black	–	–	●
Roof rails – chrome	●	●	–
Running boards – illuminated, with rubber studs	●	●	●

[Book a test drive](#)[Find your new GLS](#)[Find a Showroom](#)

Standard equipment

● Standard – Not available

Exterior (continued)

	GLS 63 4MATIC+ Night Edition AMG Line Premium Plus	Business Class	AMG Line Premium Plus
Tinted glass all round – single-layer safety glass	●	●	●
Underguard – reinforced underfloor panelling the full length of the vehicle	●	●	●

Wheels

22" AMG alloy wheels – multi-spoke design, painted high-gloss titanium grey with a high-sheen finish, with 285/45 (front) and 325/40 (rear) R22 tyres (code RPA)	●	–	–
23" AMG alloy wheels – 5-twin-spoke design, painted high-gloss black with a high-sheen finish, with 285/40 (front) and 325/35 (rear) R23 tyres (code RPQ)	–	●	–
23" AMG alloy wheels – multi-spoke design, painted matt black with a high-sheen rim flange, 285/40 (front) and 325/35 (rear) R23 rear tyres (code RXY)	–	–	●
Summer tyres	●	●	●

Interior

AIR-BALANCE package	●	●	●
Air conditioning – THERMOTRONIC luxury automatic climate control – five-zone function with separate air distribution settings for driver, front passenger and two for second row and third row seats. Three different climate modes: Focused, Medium and Diffuse	●	●	●
Ambient lighting – 64 colour ambient lighting with selectable brightness, dynamic mode, climate effects and welcome effect	●	●	●
Centre armrests – folding (rear)	●	●	●
Centre armrests – with stowage compartment (front)	●	●	●
Cupholder – temperature-controlled	●	●	●
Door sills – front door sill panels with 'Mercedes-Benz' lettering illuminated in white	●	●	–
Door sills – front door sill panels with 'AMG' lettering illuminated in white	–	–	●

	GLS 63 4MATIC+ Night Edition AMG Line Premium Plus	Business Class	AMG Line Premium Plus
ENERGIZING package Plus – six selectable programmes: 'Refresh', 'Vitality', 'Training', 'Warmth', 'Joy' and 'Comfort'. Using a combination of fragrancing, heating and cooling, massage functions and ambient lighting to change the ambience and add to driver wellbeing	●	●	●
Fingerprint scanner	●	●	●
Floor mats – AMG floor mats with edging and embroidered 'AMG' lettering	●	●	●
Head rests – comfort front head rests	●	●	●
Head rests – luxury rear head rests (outer seats)	–	●	●
Memory package – front seats, front head restraints, steering column and exterior door mirrors – electrically adjustable with memory. Four-way electric lumbar support for driver and front passenger seat	●	●	●
Reading lights (front and rear)	●	●	●
Rear Comfort package	–	●	●
Seats – climatised (front seats)	●	●	●
Seats – climatised (rear seats, second row)	–	●	●
Seats – front passenger seat electrically adjustable from the rear	–	●	●
Seats – heated (front seats)	●	●	●
Seats – heated (rear seats, second row)	●	●	●
Seats – heated (rear seats, third row)	–	●	●
Seats – multi-contour with massage function (front seats)	●	●	●
Seats – multi-contour with massage function (rear seats, second row)	–	●	●
Seats – electrically folding and raising with EASY-ENTRY system power release (rear seats, third row). This system facilitates access to the third seat row from both sides at the touch of a button. The backrests and bench seat of the second row of seats can be folded forward electrically. Pressing these switches causes the head restraints to retract electrically, while the backrests fold down. The bench seat is then folded forward	●	●	●
Sports pedals in brushed stainless steel with rubber studs	●	●	●

[Book a test drive](#)[Find your new GLS](#)[Find a Showroom](#)

Standard equipment

● Standard – Not available

Interior (continued)

	AMG Line Premium Plus	Business Class	GLS 63 4MATIC+ Night Edition
Star pattern light carpet	●	●	●
Stowage – EASY-PACK load compartment cover (removable)	●	●	●
Stowage – load-securing rings (6)	●	●	●
Sun blinds – electrically-operated sun blinds in rear side windows	–	●	●
Sun visors – double sun visors with illuminated vanity mirrors	●	●	●
Warmth Comfort package	●	●	●

Paint, Trim and Upholstery

Paint – metallic	●	●	●
Trim – AMG carbon-fibre trim	–	–	●
Trim – anthracite open-pore oak wood trim	●	●	–
Upholstery – AMG Style Exclusive nappa leather	–	–	●
Upholstery – beltlines on doors, upper and lower part of the dashboard in ARTICO man-made leather	●	●	–
Upholstery – beltlines on doors, upper and lower part of the dashboard in nappa leather	–	–	●
Upholstery – leather	●	●	–

Safety and Assistance Systems

Active bonnet – pedestrian safety measure	●	●	●
Active Stop-and-Go Assist	●	●	●
Airbags – driver and front passenger	●	●	●
Airbags – driver's kneebag	●	●	●
Airbags – front sidebags	●	●	●

	AMG Line Premium Plus	Business Class	GLS 63 4MATIC+ Night Edition
Airbags – rear sidebags, left and right	●	●	●
Airbags – windowbags	●	●	●
Alarm system with immobiliser and interior protection (Thatcham category 1)	●	●	●
Anti-lock braking system (ABS) with Brake Assist (BAS)	●	●	●
ATTENTION ASSIST	●	●	●
Automatic child seat recognition sensor	●	●	●
Braking – Adaptive Brake Assist with HOLD function, Hill Start Assist, priming and dry braking in the wet	●	●	●
Braking – adaptive brake lights	●	●	●
Braking – AMG high-performance composite braking system	–	–	●
Braking – braking system with larger brake disks on the front axle	●	●	–
Braking – electric parking brake	●	●	●
Braking – red painted brake calipers with 'AMG' lettering	–	–	●
Braking – third brake light, LED technology	●	●	●
Crosswind Assist – detects sudden, strong gusts of wind and helps the driver stay in lane by means of targeted braking	●	●	●
Dash cam	●	●	●
Driving Assistance package Plus ¹	●	●	●
Electronic Stability Programme (ESP®) with Acceleration Skid Control (ASR)	●	●	●
Four-wheel Electronic Traction System (4ETS)	●	●	●
GUARD 360° vehicle protection ²	●	●	●
i-Size child seat fixing points (two outer second row seats and two third row seats)	●	●	●
Parking package – Active Parking Assist ¹ including PARKTRONIC and 360° camera	●	●	●

¹Our driver assistance and safety systems are aids and do not relieve you of your responsibility as the driver. Please take note of the information in the Owner's Manual and the system limits which are described therein

²The connection of the communication module to the mobile phone network including the emergency call system depends on the respective network coverage and availability

[Book a test drive](#)[Find your new GLS](#)[Find a Showroom](#)

Standard equipment

● Standard – Not available

Safety and Assistance Systems (continued)

	AMG Line Premium Plus	Business Class	GLS 63 4MATIC+ Night Edition
Remote central locking	●	●	●
Service indicator ASSYST	●	●	●
SPEEDTRONIC cruise control	●	●	●
Tyre pressure monitoring system	●	●	●

Communications and In-Car Entertainment

5G communication module ¹	●	●	●
AMG Track Pace	–	–	●
Burmester® surround sound system	●	●	●
DAB digital radio tuner	●	●	●
Digital Extras (standard services) ² – emergency call system (eCall) ³ , accident recovery, breakdown management and maintenance management	●	●	●
Head-up display	●	●	●

	AMG Line Premium Plus	Business Class	GLS 63 4MATIC+ Night Edition
MBUX High-End Rear Seat Entertainment System	–	●	●
MBUX Interior Assistant	●	●	●
MBUX rear tablet	–	●	●
Pre-installation for MBUX Entertainment	●	●	●
Smartphone integration ² – connects mobile phone with the multimedia system wirelessly via Apple CarPlay® and Android Auto™	●	●	●
Two wireless head sets	–	●	●
USB ports – additional type-C USB ports – one data-enabled USB port in the oddments tray, two USB ports (5V) in the centre console, two USB ports (5V) in the second seat row and two USB ports (5V) in the third seat row	●	●	●
Widescreen cockpit	●	●	●
Wireless charging ⁴ (front)	●	●	●
Wireless charging ⁴ (rear)	–	●	●

¹The connection of the communication module to the mobile phone network including the emergency call system depends on the respective network coverage and availability aware Mercedes-Benz emergency call system comes as standard for the first 10 years of the vehicle's lifecycle ⁴Compatible mobile phone required

²The connection of the communication module to the mobile phone network including the emergency call system depends on the respective network coverage and availability of network providers

³Please be

[Book a test drive](#)[Find your new GLS](#)[Find a Showroom](#)

Standard equipment Mercedes-Maybach

● Standard – Not available

Engine, Transmission and Suspension

	GLS 600	GLS 600 Night Series	GLS 600 First Class	GLS 600 First Class N. S.
DYNAMIC SELECT with a choice of driving modes: Eco, Comfort, Sport and Individual	●	●	●	●
E-ACTIVE BODY CONTROL	–	–	●	●
ECO start/stop function	●	●	●	●
EQ Boost starter-alternator	●	●	●	●
Four-wheel drive	●	●	●	●
Suspension – AIRMATIC air suspension with level adjustment and Adaptive Damping System	●	●	–	–
Transmission – 9G-TRONIC 9-speed automatic transmission with steering column gear selector, steering wheel gearshift paddles (Direct Select)	●	●	●	●

Steering

Direct Steering	●	●	●	●
Steering column – electrically adjustable with EASY-ENTRY function	●	●	●	●
Steering wheel – wood leather multifunction steering wheel	●	●	●	●
Steering wheel – heated	●	●	●	●

Exterior

Air inlet grilles feature a Maybach pattern	●	●	●	●
EASY-PACK powered tailgate – the EASY-PACK boot lid can be opened and closed at the touch of a button for more convenient loading and unloading of the boot	●	●	●	●
Exclusive exterior design elements in dark shadow gloss	–	●	–	●
KEYLESS-GO Comfort package – the vehicle can be conveniently unlocked, started and locked – simply by carrying the electronic key	●	●	●	●

	GLS 600	GLS 600 Night Series	GLS 600 First Class	GLS 600 First Class N. S.
Lights – Headlight Assist: automatic headlight activation	●	●	●	●
Lights – LED tail lights	●	●	●	●
Lights – MULTIBEAM LED with Adaptive Highbeam Assist Plus	●	–	●	–
Lights – MULTIBEAM LED pins in rosé gold with Maybach emblems	–	●	–	●
MAGIC VISION CONTROL – adaptive windscreen wiper system, heated	●	●	●	●
Maybach emblem in the D-pillar	●	●	●	●
Maybach lettering on the load compartment cover	●	●	●	●
Maybach-specific tailpipe trim, in a high-gloss chrome finish with horizontal trim inserts	●	●	●	●
Mirror package – including projection of Mercedes-Benz logo integrated into both mirrors – including heated exterior mirrors, automatically-dimming rear view mirror and exterior mirror on driver's side and electrically-folding exterior mirrors left and right	●	●	●	●
Panoramic glass sunroof – consists of a fixed panoramic glass sunroof above the second seat row, and an electrically-operated sliding glass front section with an electrically-operated interior sun blind	●	●	●	●
Petrol Particulate Filter	●	●	●	●
Power closing aid for doors and boot lid – power closing ensures smooth and virtually silent closing. Once they have initially engaged, the front and rear doors are automatically drawn closed by servomotors	●	●	●	●
Privacy glass – heat-insulating tinted glass from B-pillar backwards	●	●	●	●
Rain-sensing wipers	●	●	●	●
Roof rails – chrome	●	–	●	–
Roof rails – matt black	–	●	–	●
Running boards – electrically retractable and illuminated running board with Maybach emblem	●	–	●	–
Running boards – electrically retractable and illuminated running board with Maybach emblem in high-gloss black	–	●	–	●
Tinted glass all round – single-layer safety glass	●	●	●	●

[Book a test drive](#)[Find your new GLS](#)[Find a Showroom](#)

Standard equipment Mercedes-Maybach

● Standard – Not available

Exterior (continued)

	GLS 600	GLS 600 Night Series	GLS 600 First Class	GLS 600 First Class N. S.
Trailer coupling with trailer manoeuvring assist and increased towing capacity	●	●	●	●
Underguard – reinforced underfloor panelling the full length of the vehicle	●	●	●	●
Upright Mercedes star on the bonnet	●	●	●	●
Vertical chrome bars and the 'Maybach' lettering	●	●	●	●

Wheels

22" Maybach light-alloy wheels – multi-spoke design in high-gloss black with high-sheen finish, including fully integrated wheel bolt cover, 285/45 (front) and 325/40 (rear) R22 tyres (code R63)	●	–	●	–
23" Maybach light-alloy wheels – 7-spoke design, bi-chromatic finish in black/dark shadow gloss with aero elements in a Mercedes-Maybach look including fully integrated wheel bolt cover, 285/40 (front) and 325/35 (rear) R23 tyres (code 85R)	–	●	–	●
Summer tyres	●	●	●	●

Interior

AIR-BALANCE package	●	●	●	●
Air conditioning – THERMOTRONIC luxury automatic climate control – five-zone function with separate air distribution settings for driver, front passenger and two for second row and third row seats. Three different climate modes: Focused, Medium and Diffuse	●	●	●	●
Ambient lighting – 64 colour ambient lighting with selectable brightness, dynamic mode, climate effects and welcome effect	●	●	●	●
Ambient lighting – 'Garnet Glow' ambient lighting colour scheme	–	●	–	●
Centre armrests – folding (rear)	●	●	●	●
Centre armrests – with stowage compartment (front)	●	●	●	●
Cupholder – temperature-controlled	●	●	●	●
Door sills – door sill panels with 'Maybach' lettering	●	–	●	–

	GLS 600	GLS 600 Night Series	GLS 600 First Class	GLS 600 First Class N. S.
Door sills – door sill panels with 'Maybach Night Series' lettering	–	●	–	●
ENERGIZING package Plus – six selectable programmes: 'Refresh', 'Vitality', 'Training', 'Warmth', 'Joy' and 'Comfort'. Using a combination of fragrancing, heating and cooling, massage functions and ambient lighting to change the ambience and add to driver wellbeing	●	●	●	●
Fingerprint scanner	●	●	●	●
Floor mats – high pile floor mats	●	●	●	●
Folding rear tables	–	–	●	●
Head rests – comfort front head rests	●	●	●	●
Head rests – luxury rear head rests (outer seats)	●	●	●	●
Holder for two champagne flutes	–	–	●	●
Maybach emblems in dark shadow gloss	–	●	–	●
Memory package – front seats, front head restraints, steering column and exterior door mirrors – electrically adjustable with memory. Four-way electric lumbar support for driver and front passenger seat	●	●	●	●
Pedal assembly in brushed stainless steel with Maybach emblem	●	●	●	●
Reading lights (front and rear)	●	●	●	●
Rear Comfort package	●	●	●	●
Refrigerated compartment in the rear	–	–	●	●
Seats – climatized (front seats)	●	●	●	●
Seats – climatized (rear seats, second row)	●	●	●	●
Seats – front passenger seat electrically adjustable from the rear	●	●	●	●
Seats – individual luxury seats (rear)	–	–	●	●
Seats – Seat heating Plus (front seats)	●	●	●	●
Seats – multi-contour with massage function (front seats)	●	●	●	●
Seats – multi-contour with massage function (rear seats, second row)	●	●	●	●

[Book a test drive](#)[Find your new GLS](#)[Find a Showroom](#)

Standard equipment Mercedes-Maybach

● Standard – Not available

Interior (continued)

	GLS 600	GLS 600 Night Series	GLS 600 First Class	GLS 600 First Class N. S.
Seats – electrically folding and raising with EASY-ENTRY system power release (rear seats, third row). This system facilitates access to the third seat row from both sides at the touch of a button. The backrests and bench seat of the second row of seats can be folded forward electrically. Pressing these switches causes the head restraints to retract electrically, while the backrests fold down. The bench seat is then folded forward	●	●	●	●
Star pattern light carpet	●	●	●	●
Sun blinds – electrically-operated sun blinds in rear doors, left and right	●	●	●	●
Sun visors – double sun visors with illuminated vanity mirrors	●	●	●	●
Warmth Comfort package	●	●	●	●

Paint, Trim and Upholstery

	GLS 600	GLS 600 Night Series	GLS 600 First Class	GLS 600 First Class N. S.
Paint – metallic	●	●	●	●
Trim – MANUFAKTUR high-gloss black flowing lines piano lacquer trim	●	●	●	●
Upholstery – nappa leather	●	●	●	●
Upholstery – beltlines on doors, upper and lower part of the dashboard in nappa leather	●	●	●	●

Safety and Assistance Systems

	GLS 600	GLS 600 Night Series	GLS 600 First Class	GLS 600 First Class N. S.
Active bonnet – pedestrian safety measure	●	●	●	●
Active Stop-and-Go Assist	●	●	●	●
Airbags – driver and front passenger	●	●	●	●
Airbags – driver's kneebag	●	●	●	●
Airbags – front sidebags	●	●	●	●
Airbags – rear sidebags, left and right	●	●	●	●
Airbags – windowbags	●	●	●	●

	GLS 600	GLS 600 Night Series	GLS 600 First Class	GLS 600 First Class N. S.
Alarm system with immobiliser and interior protection (Thatcham category 1)	●	●	●	●
Anti-lock braking system (ABS) with Brake Assist (BAS)	●	●	●	●
ATTENTION ASSIST	●	●	●	●
Automatic child seat recognition sensor	●	●	●	●
Braking – Adaptive Brake Assist with HOLD function, Hill Start Assist, priming and dry braking in the wet	●	●	●	●
Braking – adaptive brake lights	●	●	●	●
Braking – electric parking brake	●	●	●	●
Braking – third brake light, LED technology	●	●	●	●
Crosswind Assist – detects sudden, strong gusts of wind and helps the driver stay in lane by means of targeted braking	●	●	●	●
Dash cam	●	●	●	●
Driving Assistance package Plus ¹	●	●	●	●
Electronic Stability Programme (ESP®) with Acceleration Skid Control (ASR)	●	●	●	●
Four-wheel Electronic Traction System (4ETS)	●	●	●	●
GUARD 360° vehicle protection Plus	●	●	●	●
Hill-Start Assist	●	●	●	●
i-Size child seat fixing points (two outer second row seats and two third row seats)	●	●	●	●
Parking package – Active Parking Assist ¹ including PARKTRONIC and 360° camera	●	●	●	●
Remote central locking	●	●	●	●
Service indicator ASSYST	●	●	●	●
SPEEDTRONIC cruise control	●	●	●	●
Tyre pressure monitoring system	●	●	●	●

¹Our driver assistance and safety systems are aids and do not relieve you of your responsibility as the driver. Please take note of the information in the Owner's Manual and the system limits which are described therein

[Book a test drive](#)[Find your new GLS](#)[Find a Showroom](#)

Standard equipment Mercedes-Maybach

● Standard – Not available

Communications and In-Car Entertainment

	GLS 600	GLS 600 Night Series	GLS 600 First Class	GLS 600 First Class N. S.		GLS 600	GLS 600 Night Series	GLS 600 First Class	GLS 600 First Class N. S.
5G communication module ¹	●	●	●	●	Night Series start-up-animation on the media display	–	●	–	●
Burmester® high-end 3D surround sound system	–	–	●	●	Pre-installation for MBUX Entertainment	●	●	●	●
Burmester® surround sound system	●	●	–	–	Smartphone integration ⁴ – connects mobile phone with the multimedia system wirelessly via Apple CarPlay® and Android Auto™	●	●	●	●
DAB digital radio tuner	●	●	●	●	Two wireless head sets	●	●	●	●
Digital Extras (standard services) ² – emergency call system (eCall) ³ , accident recovery, breakdown management and maintenance management	●	●	●	●	USB ports – additional type-C USB ports – one data-enabled USB port in the oddments tray, two USB ports (5V) in the centre console, two USB ports (5V) in the second seat row and two USB ports (5V) in the third seat row	●	●	●	●
Head-up display	●	●	●	●	Widescreen cockpit – comprising two displays, each with a 12.3-inch screen diagonal and a specific 'Maybach' display style	●	●	●	●
MBUX High-End Rear Seat Entertainment System	●	●	●	●	Wireless charging ⁴ (front and rear)	●	●	●	●
MBUX Interior Assistant	●	●	–	–					
MBUX rear tablet	●	●	●	●					

¹The connection of the communication module to the mobile phone network including the emergency call system depends on the respective network coverage and availability aware Mercedes-Benz emergency call system comes as standard for the first 10 years of the vehicle's lifecycle ⁴Compatible mobile phone required

²The connection of the communication module to the mobile phone network including the emergency call system depends on the respective network coverage and availability of network providers

³Please be

Genuine accessories

We've developed a range of accessories you can add to help personalise and enhance your GLS.



Basic carrier bars for roof rails

The Alustyle basic carrier bars offer a multifunctional basis for attaching all of the Mercedes-Benz transport and leisure accessories, for example roof boxes, bicycle racks or ski racks. Tested to exacting Mercedes-Benz standards, the bars are simple to fit and offer a secure hold and optimum aerodynamics. (A1678903100)



Bicycle rack

Easy to use, convenient and lightweight. Bicycles can be attached at ground level before the rack is fitted. Up to three bicycle carriers can be fitted at one time. The alustyle cycle carrier is designed for the alustyle basic carrier bars, making your life easier, with know-how from Mercedes-Benz. (A000890029364)



Mercedes-Benz roof box 450

An aerodynamic design, tailored to your Mercedes-Benz. In extremely durable material. Designed for quick, optimised attachment to the basic carrier bars. Particularly convenient loading and unloading thanks to the option of double-sided opening. Lockable from both sides. (A0008400300)



Mercedes-AMG roof box

The innovative, aerodynamically developed design of the Mercedes-AMG roof box combines sportiness and exclusivity. With the design of the Mercedes-AMG roof box, optimum results in terms of aerodynamics, driving characteristics and background noise are attained. A simple assembly is made possible by a rapid clamping system. (A0008400900)

All the above accessories are subject to availability and compatibility. Please ask your Mercedes-Benz Authorised Repairer for more information

Design	Technology	GLS	Mercedes-AMG GLS	Mercedes-Maybach GLS	Model prices	Personalisation	Standard equipment	Genuine accessories	Technical data	Additional information
--------	------------	-----	------------------	----------------------	--------------	-----------------	--------------------	---------------------	----------------	------------------------



Bluetooth® headphones

Thanks to Bluetooth® technology, the headphones allow wireless transmission between the headphones and audio source; also, a 3.5 mm jack connection is available for wired transmission. With a 3D sound effect, the headphones offer a spacious sound experience and the Hybrid Active Noise Cancelling ensures optimum sound reproduction without disruptive ambient noise. (A2238209903)



Bluetooth® headphones, protective case

Protect your Bluetooth® headphones wherever the road takes you with this simple yet sophisticated protective Case by Mercedes-Benz. (A2235850100)



Media Interface consumer cable kit

The Media Interface Performance Cable kit promises comfortable and secure operation of external audio devices via the operating units of the vehicle whilst driving. Additional information such as folder structure, artist or track title are displayed on the vehicle display or instrument cluster. At the same time, the battery of the connected device is charged up. (A1778203001)



AMG KIDFIX XP child seat, with ISOFIT, ECE + China

AMG child seat for children aged approximately 3.5 to 12 years (15 to 36 kg). Forward-facing and securely connected to the vehicle using a three-point seat belt or additionally using ISOFIX. With side impact protection in the form of a high-energy absorbing pad. The adjustable head restraint allows the seat to match the child's growth. The cover, in an exclusive AMG design with original AMG Dinamica seat cover material, can be removed and washed. Mesh appliqué with horizontal stripes just the same as the AMG car seats. (A0009703302)

Reversible mat, with Velcro strip for load sill guard

Black reversible mat. 100% polyester. Double-sided: rubberised, non-slip side and high-quality velour side. Design allows concertina load sill protector to be connected. Tailored to contours of load compartment. Helps protect load compartment floor from spillages and dirt. Easy to clean. (A1676846600)



All the above accessories are subject to availability and compatibility. Please ask your Mercedes-Benz Authorised Repairer for more information

[Book a test drive](#)[Find your new GLS](#)[Find a Showroom](#)

Technical data

● Standard – Not available

Model	GLS 450 d 4MATIC	GLS 450 4MATIC	Mercedes-AMG GLS 63 4MATIC+	Mercedes-Maybach GLS 600 4MATIC
Engine				
Fuel delivery	Diesel	Petrol	Petrol	Petrol
Total displacement	cc 2,989	2,999	3,982	3,982
Arrangement/cylinders/valves	in-line/6/24	in-line/6/24	V/8/32	V/8/32
Power ¹	hp (kW) at rpm			
Combustion engine	367 (270)/4,000	381 (280)/5,800–6,100	612 (450)/5,750–6,500	557 (410)/6,000–6,500
Electric motor	–	–	22 (16)	22 (16)
Torque ¹	Nm at rpm	500/1,800–5,000	850/2,500–4,500	770/2,500–4,500
Compression ratio	15.5:1	10.5:1	8.6:1	8.6:1
Emissions standard	Euro 6e	Euro 6e	Euro 6e	Euro 6e
Transmission				
9G-TRONIC 9-speed automatic	●	●	–	●
AMG SPEEDSHIFT TCT 9-speed sports transmission	–	–	●	–
Performance				
Acceleration 0–62 mph	sec 6.1	6.1	4.2	4.9
Top speed (electric mode)	mph 155	155	174	155

¹Figures according to Directive 80/1269/EEC in the currently applicable version

[Book a test drive](#)[Find your new GLS](#)[Find a Showroom](#)

Technical data

Model		GLS 450 d 4MATIC	GLS 450 4MATIC	Mercedes-AMG GLS 63 4MATIC+	Mercedes-Maybach GLS 600 4MATIC
Weights and capacities					
Kerb weight ²	kg	2,810–2,873	2,730–2,790	2,842–2,883	2,951–3,058
Perm. Gross Vehicle Weight	kg	3,300	3,230	3,395	3,270
Towing capacity – unbraked/braked	kg	750/3,500	750/3,500	750/3,300	750/3,500
Boot capacity – seats up/seats down	l	355/2,400	355/2,400	355/2,400	520
behind 1st row of seats	l	1,470	1,470	-	-
behind 2nd row of seats	l	890	890	-	-
behind 3rd row of seats	l	355	355	-	-
Fuel tank capacity/of which reserve	l	90/9	90/9	90/12	90/12
Turning circle	m	12.54	12.54	13.10	12.54
Wading depth	mm	500	500	-	-
Fuel consumption^{3,4,5}					
Combined (consumption dependent on chosen optional equipment)	l/100 km mpg	8.5–8.3 33.2–34.0	10.9–10.6 25.9–26.7	13.5–13.4 20.9–21.1	13.9–13.8 20.3–20.5
Insurance					
Group rating		50E	50E	50E	50E

Insurance ratings may vary depending on model line and specification.

²Mass of the vehicle in running order with at least 90% full fuel tank, plus the mass of the driver (estimated by law at 75 kg), fuel and fluids, equipped with the standard equipment as specified by the manufacturer as well as, where applicable, the mass of the body, cab, trailer coupling and spare wheel(s) as well as tools. Optional extras, additional equipment and accessories can influence the weight, residual payload, rolling resistance, aerodynamics, etc., and therefore also affect the consumption/CO₂ values ³All figures are based on a standard specification with the smallest tyre size ⁴The choice of wheels and transmission may affect CO₂ emissions and corresponding Road Fund Licence ⁵The indicated values were determined according to the prescribed measurement method - Worldwide Harmonised Light Vehicle Test Procedure (WLTP). Figures shown may include options which are not available in the UK



Book a test drive



Find your new GLS



Find a Showroom

GLS450/d

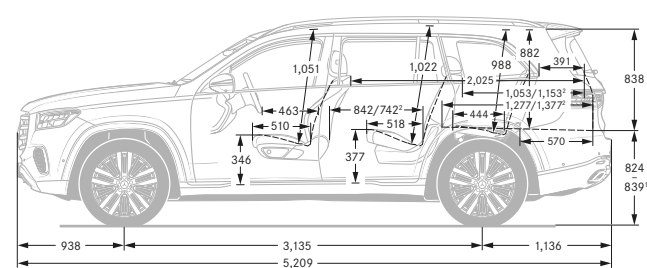
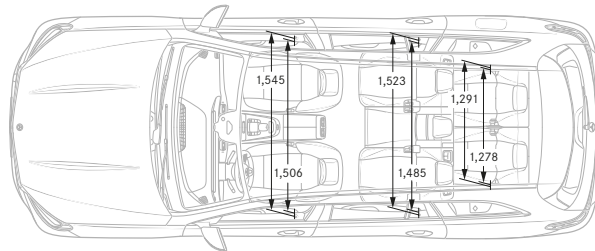
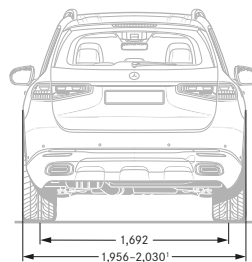
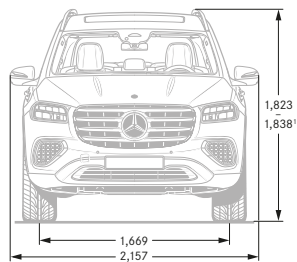

Mercedes-AMG GLS63 4MATIC+

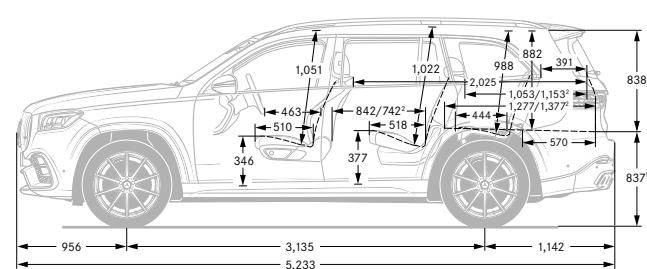
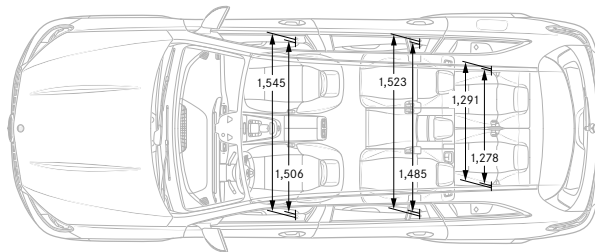
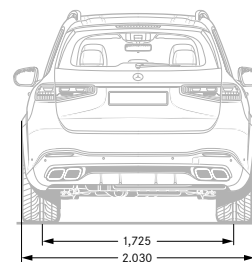
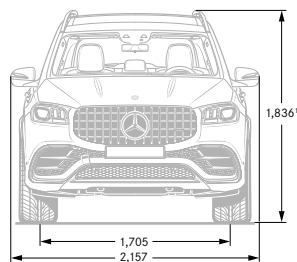

¹With minimum to maximum-size tyres at normal or highway level

²With rear bench seat pushed forward 100 mm

All measurements in millimetres. The dimensions shown are mean values and apply to standard-specification, unladen vehicles

Design	Technology	GLS	Mercedes-AMG GLS	Mercedes-Maybach GLS	Model prices	Personalisation	Standard equipment	Genuine accessories	Technical data	Additional information
--------	------------	-----	------------------	----------------------	--------------	-----------------	--------------------	---------------------	----------------	------------------------

[Book a test drive](#)[Find your new GLS](#)[Find a Showroom](#)

Mercedes-Maybach GLS 600 4MATIC

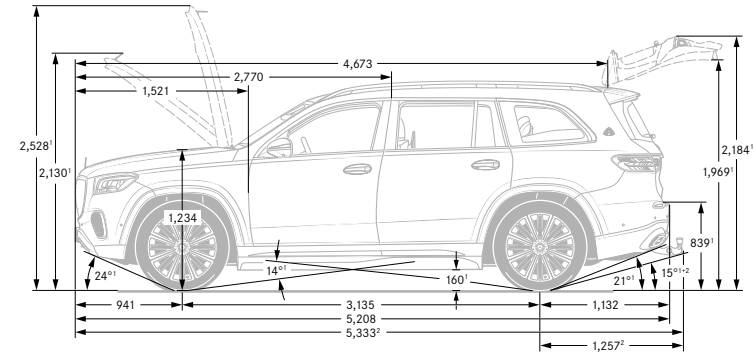
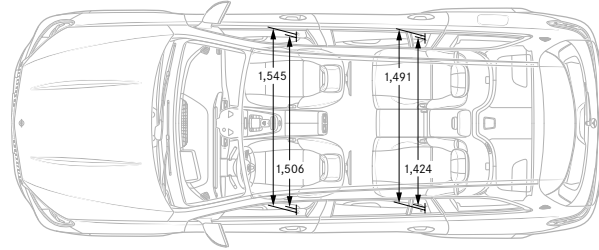
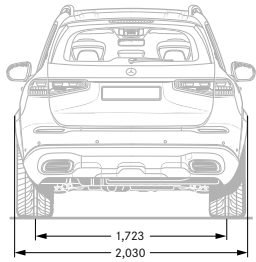
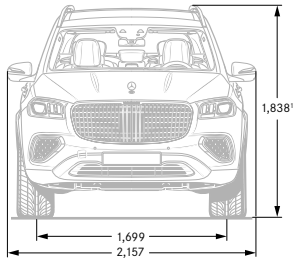

¹With "On-road" suspension setting All measurements in millimetres. The dimensions shown are mean values and apply to standard-specification, unladen vehicles

Design	Technology	GLS	Mercedes-AMG GLS	Mercedes-Maybach GLS	Model prices	Personalisation	Standard equipment	Genuine accessories	Technical data	Additional information
--------	------------	-----	------------------	----------------------	--------------	-----------------	--------------------	---------------------	----------------	------------------------



Book a test drive



Find your new GLS



Find a Showroom

GLS 450/d

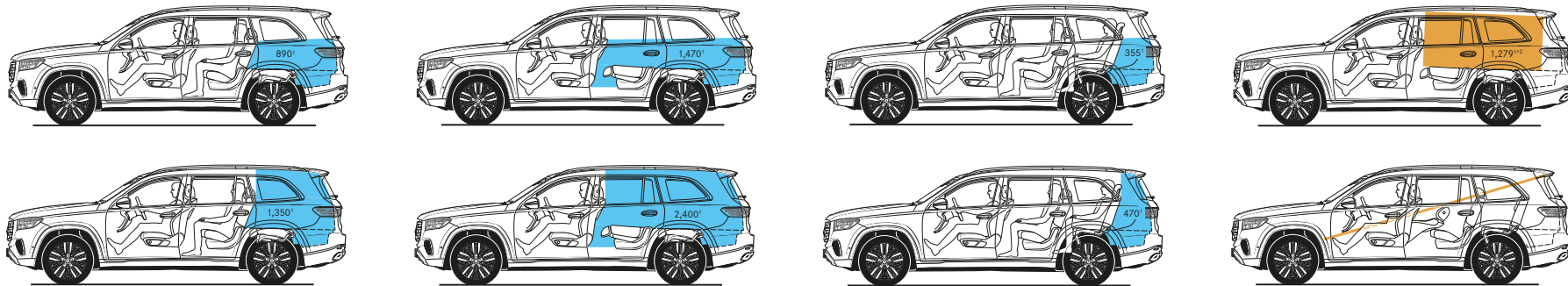

Luggage compartment capacity according to guideline ISO 3832:2002-06, Luggage compartment capacity may differ depending on optional extras

¹Volume in litres

²Largest cuboid: dimensions 1,898 × 1,015 × 664 mm, volume 1,279 litres

³Longest board: dimensions 3,546 × 400 × 30 mm

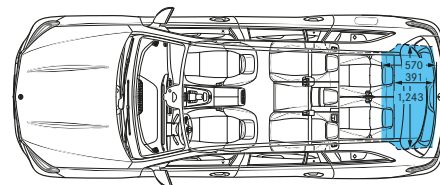
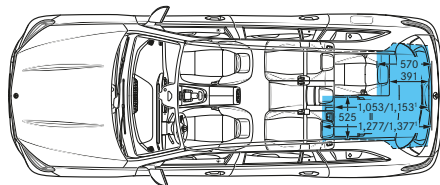
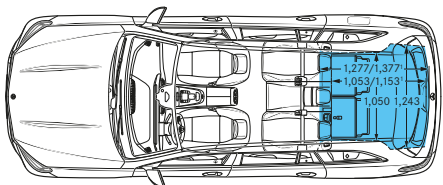
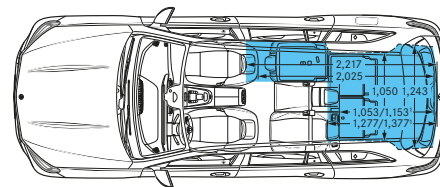
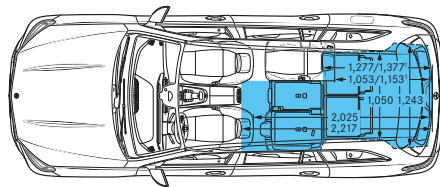
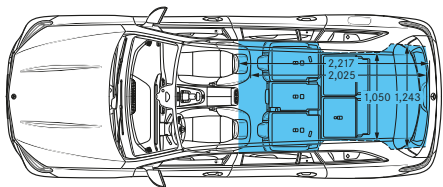

⁴With rear bench seat pushed forward 100 mm

Design	Technology	GLS	Mercedes-AMG GLS	Mercedes-Maybach GLS	Model prices	Personalisation	Standard equipment	Genuine accessories	Technical data	Additional information
--------	------------	-----	------------------	----------------------	--------------	-----------------	--------------------	---------------------	----------------	------------------------



Road Fund Licence

All road vehicle registrations are subject to Vehicle Excise Duty (Road Fund Licence), which varies in accordance with the vehicle's CO₂ emissions. A first year rate for each taxation band will apply. The table below shows the bands (A-M) created by the DVLA and the corresponding Road Fund Licence. CO₂ emissions and the relevant Excise Duty are shown on the model pricing pages.

VED applicable for registrations up to 31 March 2025

Band	CO ₂ emissions (g/km)	First year rate petrol and RDE2 diesel (£)	First year rate alternative fuel (£)	Electric vehicles		Alternative fuel vehicles		Petrol/diesel vehicles	
				Standard rate (£)	Premium rate (£) ¹	Standard rate (£)	Premium rate (£) ¹	Standard rate (£)	Premium rate (£) ¹
A	0	0.00	0.00	0.00	0.00	0.00	0.00	0.00	0.00
B	1 to 50	10.00	0.00	0.00	0.00	180.00	590.00	190.00	600.00
C	51 to 75	30.00	20.00	0.00	0.00	180.00	590.00	190.00	600.00
D	76 to 90	135.00	125.00	0.00	0.00	180.00	590.00	190.00	600.00
E	91 to 100	175.00	165.00	0.00	0.00	180.00	590.00	190.00	600.00
F	101 to 110	195.00	185.00	0.00	0.00	180.00	590.00	190.00	600.00
G	111 to 130	220.00	210.00	0.00	0.00	180.00	590.00	190.00	600.00
H	131 to 150	270.00	260.00	0.00	0.00	180.00	590.00	190.00	600.00
I	151 to 170	680.00	670.00	0.00	0.00	180.00	590.00	190.00	600.00
J	171 to 190	1,095.00	1,085.00	0.00	0.00	180.00	590.00	190.00	600.00
K	191 to 225	1,650.00	1,640.00	0.00	0.00	180.00	590.00	190.00	600.00
L	226 to 255	2,340.00	2,330.00	0.00	0.00	180.00	590.00	190.00	600.00
M	over 255	2,745.00	2,735.00	0.00	0.00	180.00	590.00	190.00	600.00



Some of the model features, optional extras and colours shown may not be available, or may only be available in a different specification, or at a different price
¹Premium rate only applicable to vehicles where the list price is over £40,000 including any factory-fitted options, standard UK delivery charge and VAT



Services and insurance

Mercedes-Benz Service Plans

We believe that servicing and repair costs should be as flexible and affordable as possible for your GLS, which is why we offer a choice of Service Plans to make it easy to budget for all your servicing, MOT and repair costs. It spreads your bills into manageable monthly payments based on whether you have a new or used Mercedes-Benz.

- **ServiceCare** – guarantees the price of parts and labour for up to four services and safeguards against any inflationary influences. It also covers your annual MOT fees depending on the age of your vehicle when you take your plan out.
- **CompleteCare** – our most comprehensive plan covering all your servicing, MOT, wear & tear needs as well as Extended Warranty once your vehicle turns four years old.
- **Extended Warranty** – protect yourself against sudden or unexpected repair costs after your initial warranty period has ended after three years. There are three policy options to choose from: 12-month, 24-month or a monthly pay-as-you-go option.

[Click here for more information](#)

Motor Insurance

We know that once you have chosen your Mercedes-Benz you can't wait to drive it – that's why we created First Cover¹. It gives you 5 days' free comprehensive Motor Insurance when you buy a new or used vehicle from a Mercedes-Benz Agent. We will also send you a quote for annual cover, so you can enjoy the same peace of mind all year round.

[Apply for First Cover](#)

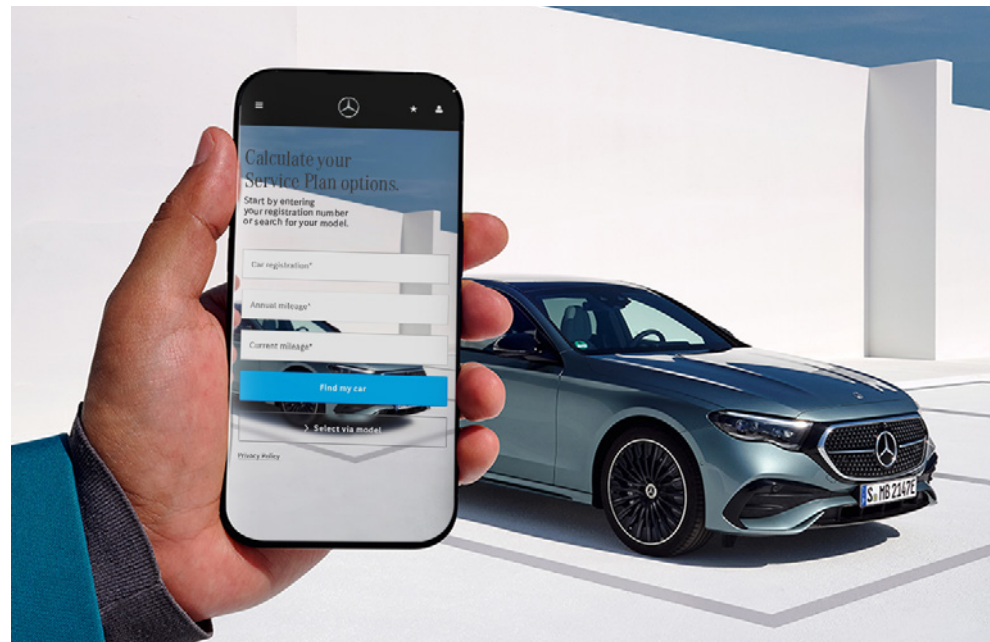

Warranty and breakdown cover

Every Mercedes-Benz comes with a three-year unlimited mileage warranty against manufacturing or material defects² and up to 30 years warranty against perforation due to corrosion from the inside out.³ What's more, it's also covered by Mercedes-Benz Roadside Assistance – a unique package comprising up to 30 years pan-European breakdown assistance.³

¹Terms and Conditions apply. We are an independent intermediary dealing with selected insurers in respect of annual insurance

²Applies to vehicles sold by Mercedes-Benz in the UK to its franchised Mercedes-Benz Agents

³Subject to full Terms and Conditions, dependent on date of registration, available upon request



Effective from January 2025 Production. Information correct at time of publication 17.10.2024.

Prices and specifications are subject to change without prior notice.

MBX167/0225 MY805.5

