



AMG



# MERCEDES-AMG GT COUPÉ

Effective from January 2025 Production.





Book a test drive



Find your Mercedes-AMG GT



Find a Showroom



Some of the model features, optional extras and colours shown may not be available, or may only be available in a different specification, or at a different price.

Design	Technology	Plug-in Hybrid	Model lines	Driving experience	Model prices	Personalisation	Standard equipment	Technical data	Additional information
--------	------------	----------------	-------------	--------------------	--------------	-----------------	--------------------	----------------	------------------------



Book a test drive



Find your Mercedes-AMG GT



Find a Showroom



Some of the model features, optional extras and colours shown may not be available, or may only be available in a different specification, or at a different price.

Design	Technology	Plug-in Hybrid	Model lines	Driving experience	Model prices	Personalisation	Standard equipment	Technical data	Additional information
--------	------------	----------------	-------------	--------------------	--------------	-----------------	--------------------	----------------	------------------------





Book a test drive



Find your Mercedes-AMG GT



Find a Showroom



Some of the model features, optional extras and colours shown may not be available, or may only be available in a different specification, or at a different price.

Design	Technology	Plug-in Hybrid	Model lines	Driving experience	Model prices	Personalisation	Standard equipment	Technical data	Additional information
--------	------------	----------------	-------------	--------------------	--------------	-----------------	--------------------	----------------	------------------------





Some of the model features, optional extras and colours shown may not be available, or may only be available in a different specification, or at a different price.

Design	Technology	Plug-in Hybrid	Model lines	Driving experience	Model prices	Personalisation	Standard equipment	Technical data	Additional information
--------	------------	----------------	-------------	--------------------	--------------	-----------------	--------------------	----------------	------------------------





Some of the model features, optional extras and colours shown may not be available, or may only be available in a different specification, or at a different price.

Design	Technology	Plug-in Hybrid	Model lines	Driving experience	Model prices	Personalisation	Standard equipment	Technical data	Additional information
--------	------------	----------------	-------------	--------------------	--------------	-----------------	--------------------	----------------	------------------------





Book a test drive



Find your Mercedes-AMG GT



Find a Showroom



Some of the model features, optional extras and colours shown may not be available, or may only be available in a different specification, or at a different price.

Design	Technology	Plug-in Hybrid	Model lines	Driving experience	Model prices	Personalisation	Standard equipment	Technical data	Additional information
--------	------------	----------------	-------------	--------------------	--------------	-----------------	--------------------	----------------	------------------------





Some of the model features, optional extras and colours shown may not be available, or may only be available in a different specification, or at a different price.

Design	Technology	Plug-in Hybrid	Model lines	Driving experience	Model prices	Personalisation	Standard equipment	Technical data	Additional information
--------	------------	----------------	-------------	--------------------	--------------	-----------------	--------------------	----------------	------------------------



Some of the model features, optional extras and colours shown may not be available, or may only be available in a different specification, or at a different price.

Design	Technology	Plug-in Hybrid	Model lines	Driving experience	Model prices	Personalisation	Standard equipment	Technical data	Additional information
--------	------------	----------------	-------------	--------------------	--------------	-----------------	--------------------	----------------	------------------------





Some of the model features, optional extras and colours shown may not be available, or may only be available in a different specification, or at a different price.

Design	Technology	Plug-in Hybrid	Model lines	Driving experience	Model prices	Personalisation	Standard equipment	Technical data	Additional information
--------	------------	----------------	-------------	--------------------	--------------	-----------------	--------------------	----------------	------------------------



Mercedes-AMG GT

# TECHNOLOGY

<a href="#">Design</a>	<a href="#">Technology</a>	<a href="#">Plug-in Hybrid</a>	<a href="#">Model lines</a>	<a href="#">Driving experience</a>	<a href="#">Model prices</a>	<a href="#">Personalisation</a>	<a href="#">Standard equipment</a>	<a href="#">Technical data</a>	<a href="#">Additional information</a>
------------------------	----------------------------	--------------------------------	-----------------------------	------------------------------------	------------------------------	---------------------------------	------------------------------------	--------------------------------	--



# MERCEDES-BENZ USER EXPERIENCE (MBUX)

Transforming the in-car user experience, thanks to MBUX: Controlled via voice or touch input, the innovative infotainment system can over time even predict personal habits thanks to artificial intelligence.

## Voice control

- Activated by the keywords “Hey Mercedes”, the new intelligent voice control LINGUATRONIC<sup>1</sup> lets you control many of the infotainment functions, including destination input, phone calls or music selection
- MBUX is able to understand different accents and will adjust to you over time
- MBUX even understands indirect commands. Feeling chilly? Just say “I feel cold” and MBUX will adjust the temperature for you

## Touch inputs

- Beside voice control you can operate MBUX via touchscreen, the touchpad on the centre console, as well as touch control buttons on the steering wheel
- The touchpad recognises your handwriting should you wish to enter addresses or phone numbers silently

## Personalisation

- Turn the Mercedes-AMG GT into your very own Mercedes-AMG by personalising driving modes, radio stations and much more
- Your personal settings can be saved in up to seven different profiles, making your driving experience the best one possible
- Thanks to artificial intelligence, MBUX is able to learn and adapt over time. It will be able to predict your personal habits, such as navigation for frequently-driven routes, or the radio station you like to listen to on your way home from work

## Maintenance and service

- Wondering when the next service is due? Or how much further you can drive until you need to stop at a petrol station? Just ask your MBUX – it will tell you the answer



The connection of the communication module to the mobile phone network including the emergency call system depends on the respective network coverage and availability of network providers

<sup>1</sup>LINGUATRONIC off-board functions are currently only available for three years

Design	Technology	Plug-in Hybrid	Model lines	Driving experience	Model prices	Personalisation	Standard equipment	Technical data	Additional information
--------	------------	----------------	-------------	--------------------	--------------	-----------------	--------------------	----------------	------------------------

# DIGITAL EXTRAS

Stay connected any time, anywhere.

Digital Extras are a range of innovative online services designed to enhance your Mercedes-Benz experience. Accessible via mobile, tablet or PC, Digital Extras let you enjoy the highest standards of care and support, in a way that integrates seamlessly with your busy lifestyle.



### Safety and Service - Digital Extras helps to keep you and your car safe

Check your car's oil level, tyre pressure and fuel from your phone so you'll be ready for every journey.

### Infotainment - Online and Entertainment services

Love music? Get a 3-month free subscription to Tidal when you connect your car.

### Comfort - connect to your car anytime, anywhere

Forgot to lock your car? With Remote Car Lock<sup>1</sup> you will receive a notification on your smartphone to let you know. With one tap, you can lock and unlock your vehicle so you never have to worry.

### Live Traffic Information, Parked Vehicle Locator and much more

Forgot where you've parked? Parked Vehicle Locator<sup>1</sup> will show you exactly where your car is as long as you're in a 1-mile radius of where you parked. Real-time traffic data and dynamic route with shorter journey times.

For more information speak to your local Mercedes-Benz Agent or visit the Mercedes-Benz store at [shop.mercedes-benz.com/en-gb/connect](http://shop.mercedes-benz.com/en-gb/connect)

The connection of the communication module to the mobile phone network including the emergency call system depends on the respective network coverage and availability of network providers



# DIGITAL LIGHT

High-definition headlamps with innovative features

The new innovative DIGITAL LIGHT headlamps works like a projector with more than one million pixels per headlamp and responds with brilliant light to changing traffic, road or weather conditions. Its ULTRA RANGE Highbeam with 650 m makes you feel like driving at daylight.



Some of the model features, optional extras and colours shown may not be available, or may only be available in a different specification, or at a different price.



Mercedes-AMG GT

# PLUG-IN HYBRID



[Book a test drive](#)[Find your Mercedes-AMG GT](#)[Find a Showroom](#)

# PLUG-IN HYBRID ELECTRIC VEHICLE (PHEV) The Mercedes-AMG GT 63 S E PERFORMANCE.

The new Mercedes-AMG GT 63 S E PERFORMANCE Coupé combines the best of two worlds: outstanding AMG power meets innovative, highly efficient hybrid technology.

**Mercedes-AMG GT 63 S E PERFORMANCE**  
Petrol – 3,982 cc, 8-cylinder, 612 hp/450 kW  
Electric motor – 204 hp/150 kW

**Available as:**  
Premium Plus and Ultimate

**OTR from £180,745<sup>1</sup>**

## Standard equipment

- 150 kW electric motor for combined system output of 816 hp
- Battery with a capacity of 4.8 kWh and high-performance cooling that tolerates high charging and discharging currents
- Charging cable – Mode 2 cable (5 metres, straight) for domestic socket
- Charging cable – Mode 3 cable (8 metres, straight) for wallbox and public charging station
- Charging socket
- Charging system rated at 3.7 kW AC
- Pre-entry climate control<sup>2</sup>
- Radar-based recuperation
- Remote and Charging Services Premium<sup>2</sup>



## Technical details

Equivalent All-Electric Range (EAER) <sup>3</sup>	8 miles
Charging time	
Wallbox (3.7 kW AC, 3-phase) 25–100% <sup>4</sup>	3 hrs 40 mins
Electric range consumption, combined <sup>3,5</sup>	339 kWh/km
Battery type (usable)	lithium-ion (4.8 kWh)
Capacity on-board charger	3.7 kW AC

<sup>1</sup>The recommended on-the-road price includes the Road Fund Licence applicable to the standard model plus delivery charge (£730.00 incl. VAT), new vehicle registration fee (£55.00), fuel (£50.00 incl. VAT), and number plates (£25.00 incl. VAT). VAT is calculated at the standard rate of 20%. Some of the model features, optional extras and colours shown may not be available, or may only be available in a different specification, or at a different price. <sup>2</sup>The connection of the communication module to the mobile phone network including the emergency call system depends on the respective network coverage and availability of network providers. <sup>3</sup>The indicated values were determined according to the prescribed measurement method - Worldwide Harmonised Light Vehicle Test Procedure (WLTP). Figures shown may include options which are not available in the UK. For Plug-in Hybrid Electric Vehicle (PHEV) figures determined with the battery fully charged, using a combination of both battery power and fuel. These models require mains electricity for charging. <sup>4</sup>Specified voltage and current values refer to network infrastructure and can be limited by the vehicle. Times are from 25–100% charge using a wallbox (three-phase) or standard socket (single-phase). <sup>5</sup>The certified electrical consumption is generally determined at maximum AC charging capacity using a Mode 3 cable. It is therefore recommended that vehicles with a HV battery preferably be charged at a wallbox or an AC charging station with a Mode 3 cable in order to achieve shorter charging times and improved charging efficiency.

# MERCEDES ME CHARGE<sup>1</sup> One registration, one contract, one billing.

Mercedes me Charge<sup>1</sup> provides access to a multitude of public charging stations located in shopping centres, hotels or at motorway services. A smartphone app as well as the vehicle's navigation system show the precise location, current availability and price at the selected charging station.



## Tens of thousands charging stations in the UK

Growing network of charging providers includes bp pulse the largest charging network in the UK. Customers also get six months free bp pulse+ membership which reduces the electricity price when charging.

## Access to fast-charging stations

Enables customers to get access to charging stations of different providers with:

- Mercedes-Benz app
- RFID card
- Vehicle Head unit

## Green charging

All charging using Mercedes me Charge<sup>1</sup>, will be retrospectively 'greened' by Mercedes-Benz. Please click here for more info.



## Transparent and easy billing

One invoice charging processes for payment.

## Easy access

Charging stations are displayed in Mercedes-Benz app and in MBUX multimedia system.

## No fees

Mercedes me Charge<sup>1</sup> is standard for one year with discounted IONITY rapid-charging for one year.

<sup>1</sup>The connection of the communication module to the mobile phone network including the emergency call system depends on the respective network coverage and availability of network providers. Price information is not guaranteed and is subject to change. Please be aware that this tariff will automatically renew after the 1 year promotion period - for definitive pricing information or should you not wish to continue with the tariff, your cancellation rights and current pricing can be found <https://eu.charge.mercedes.me/web/en/daimler-gb/tariffs>





# MERCEDES ME CHARGE<sup>1</sup> Tariffs

For more transparency and predictability, enjoy numerous features tailored to your charging habits with the new Mercedes me Charge<sup>1</sup> fixed-priced tariffs S, M and L. Owners of a new Plug-in Hybrid model will be entitled to the Mercedes me Charge<sup>1</sup> tariff M free of charge for the duration of 12 months.



## Tariff L

Recommended for 'frequent drivers'

Choose our tariff L to benefit from the best fixed prices for public charging, including discounted rapid-charging at IONITY charging stations as well as all Mercedes me Charge<sup>1</sup> features. This tariff is recommended for frequent and long-distance drivers.

Consisting of:

- All Mercedes me Charge<sup>1</sup> features
- Fixed prices per kWh (AC: £0.45/kWh, after 300 mins + £0.06/min; DC: £0.59/kWh)<sup>2</sup>
- IONITY rapid-charging stations discounted (£0.59/kWh)

£10.90/month

## Tariff M

Recommended for 'regular drivers'

Should you wish to downgrade your tariff package after 12 months but still want to benefit from fixed prices, discounted rapid-charging at IONITY charging stations and complete transparency, choose tariff M. This tariff is recommended for regular drivers.

Consisting of:

- All Mercedes me Charge<sup>1</sup> features
- Fixed prices per kWh (AC: £0.52/kWh, after 300 mins + £0.06/min; DC: £0.67/kWh)<sup>2</sup>
- IONITY rapid-charging stations discounted (£0.67/kWh)

Free of charge for the duration of 12 months.

Thereafter:

£4.90/month

## Tariff S

Recommended for 'casual drivers'

Should you wish to downgrade your tariff package after 12 months, there is the option to go for tariff S, which still offers you all the Mercedes me Charge<sup>1</sup> features based on flexible prices per kWh. This tariff is recommended for casual drivers.

Consisting of:

- All Mercedes me Charge<sup>1</sup> features
- Flexible prices per kWh

£0/month

<sup>1</sup>The connection of the communication module to the mobile phone network including the emergency call system depends on the respective network coverage and availability of network providers  
promotion period – for definitive pricing information or should you not wish to continue with the tariff, your cancellation rights and current pricing can be found <https://eu.charge.mercedes.me/web/en/daimler-gb/tariffs>

<sup>2</sup>Tariff rate excludes the BP Pulse charging network

Price information is not guaranteed and is subject to change. Please be aware that this tariff will automatically renew after the 1 year

# NEXT GENERATION OF HOME EV CHARGING WITH OHME



Mercedes-Benz plug-in vehicle customers with off-street parking can benefit from the convenience and speed of charging at home by installing an Ohme charger.

## Home charging with Ohme: from £925\* incl. VAT and standard installation

### Key benefits of Ohme:

Ohme specialise in providing future-proof electric vehicle charging solutions, in particular smart, affordable and easy-to-use charging products.

Save money: If you have a time-of-use tariff or a variable tariff, you'll pay less for your electricity at certain times of the day. Ohme uses your tariff information to charge your vehicle when the price is low to maximise your savings.

Ohme is the only EV charging provider to integrate with all energy tariffs, including Intelligent Octopus and OVO Charge Anytime – the next generation, smart EV charging tariffs.

Easy installation process.

Choice of tethered or untethered units.

Award-winning customer service – check Trustpilot for more information.

A 3-year warranty is included.

Connect your charger to the Ohme smartphone app to unlock smarter and cheaper charging at home. Easy-to-use, the Ohme app will give you full control to get more from your EV.

Ohme's chargers are compliant with the UK New Smart Charger Regulations for complete peace of mind.

### OZEV Grant:

You may be entitled to claim for an OZEV grant towards the cost of your home charger!<sup>1</sup> To find out whether you are entitled please contact your local Mercedes-Benz Agent.

### Questions?

Please contact your local Mercedes-Benz Agent to submit an enquiry to your chosen charging partner on your behalf. To find your local Mercedes-Benz Agent, please click the button at the top right hand corner.

### Warning!

If you are planning to charge your Mercedes-Benz plug-in electric vehicle using a 3-pin domestic plug socket you must get a qualified electrician to inspect and sign off the socket to confirm it is safe and suitable to charge your vehicle. Do not use an electric vehicle 3-pin charge cable with an extension cord.



\*Price excludes £350 OZEV EVHS Grant. Price correct at time of publication, subject to change

<sup>1</sup>The home charger £350 Grant (including VAT) is only available to customers who meet the criteria of the Office for Zero Emission Vehicles (OZEV). For full details and eligibility criteria for the OZEV EVHS Grant, see <https://www.gov.uk/government/publications/electric-vehicle-homecharge-scheme-guidance-for-customers-version-21>.



# HOME CHARGING WITH POD POINT

 Simple, convenient, fast charging.

Mercedes-Benz plug-in vehicle customers with off-street parking can benefit from the convenience and speed of charging at home by installing a Pod Point home charger.

## Home charging with Pod Point: from £925\* incl. VAT and standard installation

For full terms and conditions please visit <https://pod-point.com/legal/home-charger-terms-of-sale>

### Key benefits of Pod Point:

Pod Point is one of the leading provider of EV charging in the UK with over 200,000 home chargepoints installed.

A comprehensive 3 year 'swap out' warranty is included.

Auto Power Balancing lets you adjust your charge so that your electrical supply doesn't get overloaded when your home is using a lot of energy.

Built-in earthing protection removes the needs for expensive earth rods.

Choice of tethered or untethered units; £925 for a 7kW universal, and £975 for 7kW tethered.

The Pod Point public network consists of over 9,200 charging bays across the UK.

5 year warranty as standard, free of charge.

The standard installation package includes up to 15m of external cabling.

Utilise charge scheduling in conjunction with an off-peak EV tariff to reduce your charging costs by 70% compared with the current Energy Price Cap<sup>1</sup>

### OZEV Grant:

You may be entitled to claim for an OZEV grant towards the cost of your home charger.<sup>2</sup> To find out whether you are entitled please contact your local Mercedes-Benz Agent.

### Questions?

Please contact your local Mercedes-Benz Agent to submit an enquiry to your chosen charging partner on your behalf. To find your local Mercedes-Benz Agent, please click the button at the top right hand corner.

### Warning!

If you are planning to charge your Mercedes-Benz plug-in electric vehicle using a 3-pin domestic plug socket you must get a qualified electrician to inspect and sign off the socket to confirm it is safe and suitable to charge your vehicle. Do not use an electric vehicle 3-pin charge cable with an extension cord.



<sup>1</sup>Price excludes £350 OZEV EVHS Grant. Price correct at time of publication, subject to change <sup>2</sup>Based on an off-peak tariff of 8 p/kWh compared with the energy price cap as of 1 October 2023 of 26.92 p/kWh <sup>3</sup>The home charger £350 Grant (including VAT) is only available to customers who meet the criteria of the Office for Zero Emission Vehicles (OZEV). For full details and eligibility criteria for the OZEV EVHS Grant, see <https://www.gov.uk/government/publications/electric-vehicle-homecharge-scheme-guidance-for-customers-version-21>.

# AMG HIGH-PERFORMANCE BATTERY Lightweight, durable and compact



4.8 kWh capacity

150 kW peak power

70 kW continuous power

Direct cooling of battery cells

89 kg total weight

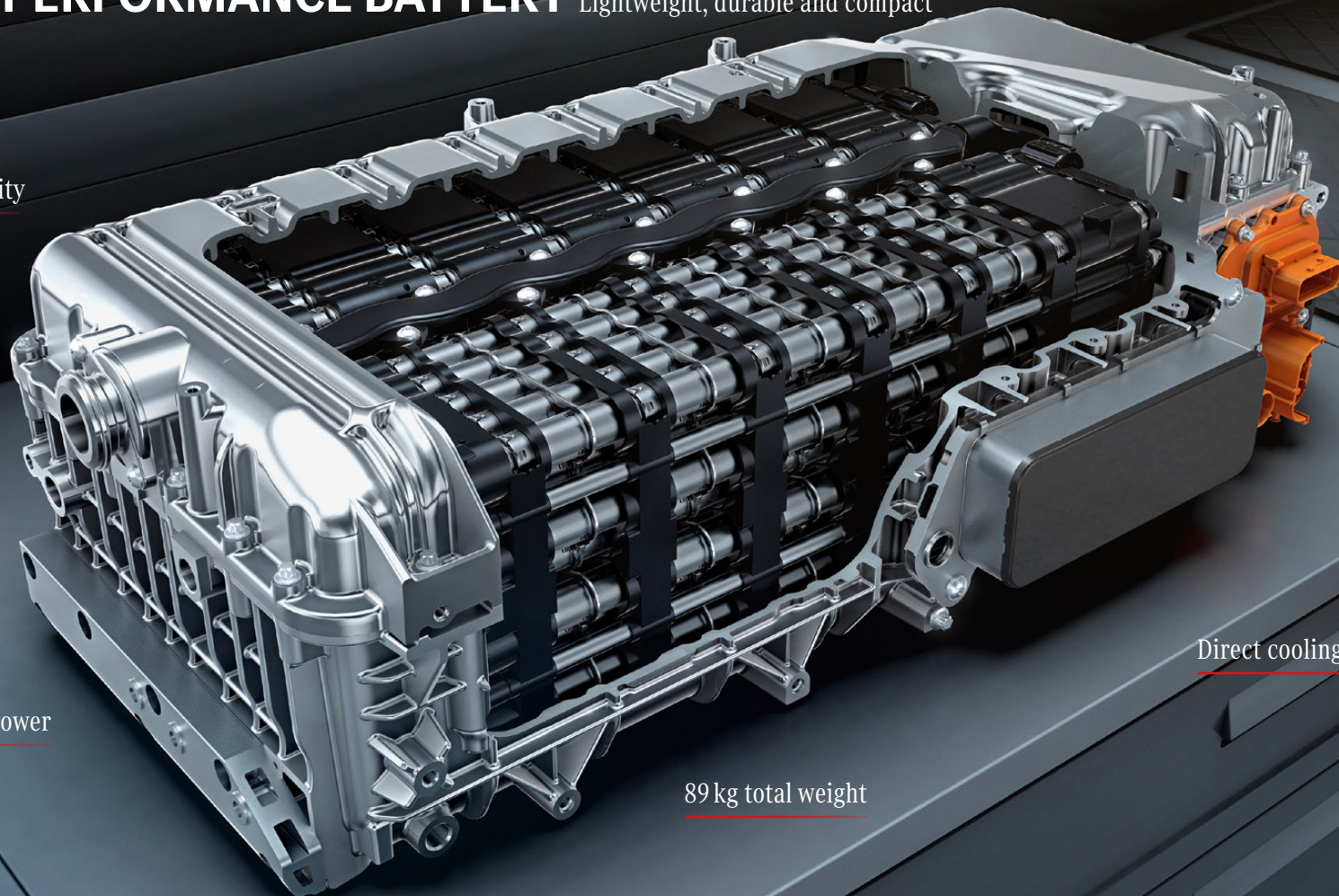

<a href="#">Design</a>	<a href="#">Technology</a>	<a href="#">Plug-in Hybrid</a>	<a href="#">Model lines</a>	<a href="#">Driving experience</a>	<a href="#">Model prices</a>	<a href="#">Personalisation</a>	<a href="#">Standard equipment</a>	<a href="#">Technical data</a>	<a href="#">Additional information</a>
------------------------	----------------------------	--------------------------------	-----------------------------	------------------------------------	------------------------------	---------------------------------	------------------------------------	--------------------------------	--



# PERFORMANCE HYBRID Compact intergrated unit on the rear axle



E-motor, 2-speed transmission and limited slip differential in one compact unit

Position of rear axle improves weight and axle load distribution

Up to 150 kW power

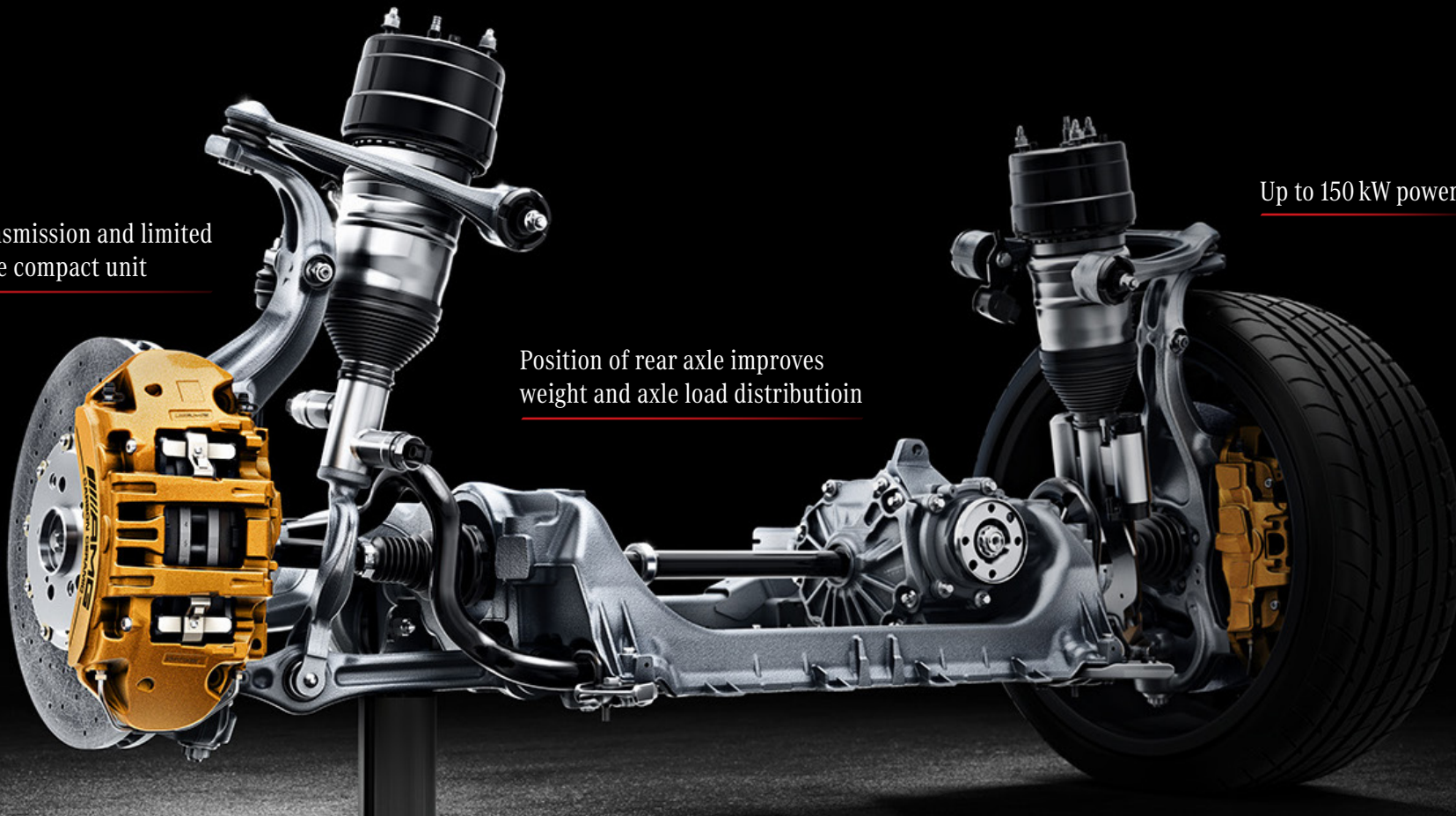

Design	Technology	Plug-in Hybrid	Model lines	Driving experience	Model prices	Personalisation	Standard equipment	Technical data	Additional information
--------	------------	----------------	-------------	--------------------	--------------	-----------------	--------------------	----------------	------------------------

# PERFORMANCE HYBRID

Benefits of the P3 layout



Optimised weight and axle load distribution  
for top traction and ideal handling

Optimum efficiency  
with recuperation

High efficiency of  
the overall drive



2-speed transmission for very agile  
driving experience and increased comfort

The electric motor acts directly on the  
rear axle and can convert its power more  
directly into propulsion



# PERFORMANCE HYBRID

Outstanding performance for dynamic optimisation



Electric drive unit with electric motor,  
2-speed transmission and rear axle  
limited slip differential

Belt driven  
starter alternator

AMG High-Performance  
Battery 150 kW of output

M177 AMG 4.0-litre V8  
BITURBO engine with over  
450 kW system output

AMG SPEEDSHIFT  
MCT transmission

# MERCEDES-AMG GT COUPÉ Model lines overview



Mercedes-AMG GT 43 Premium »



Mercedes-AMG GT 43 Premium Plus »

Mercedes-AMG GT 55 4MATIC Premium Plus »



Mercedes-AMG GT 63 4MATIC+ Premium Plus »



Mercedes-AMG GT 63 S E PERFORMANCE Premium Plus »



Mercedes-AMG GT 63 4MATIC+ Ultimate »



Mercedes-AMG GT 63 S E PERFORMANCE Ultimate »





# MERCEDES-AMG GT 43 PREMIUM Standard equipment highlights



Option shown: MANUFAKTUR opalite white bright (code 885)



Option shown: MANUFAKTUR opalite white bright (code 885)

## Engine, Transmission and Suspension

AMG RIDE CONTROL suspension

AMG Track Pace

AMG SPEEDSHIFT MCT 9-speed sport automatic transmission

## Exterior

20" AMG wheels – multi-spoke design, painted titanium grey with a high-sheen finish (code RVM)

AMG Night package

AMG brake callipers painted silver

DIGITAL LIGHT

KEYLESS-GO with seamless door handles

MAGIC VISION CONTROL

Mirror package

Panoramic fixed glass roof

Summer tyres



OTR from **£101,695<sup>1</sup>**

<sup>1</sup>The recommended on-the-road price includes the Road Fund Licence applicable to the standard model plus delivery charge (£730.00 incl. VAT), new vehicle registration fee (£55.00), fuel (£50.00 incl. VAT), and number plates (£25.00 incl. VAT). VAT is calculated at the standard rate of 20%. Some of the model features, optional extras and colours shown may not be available, or may only be available in a different specification, or at a different price

Design	Technology	Plug-in Hybrid	Model lines	Driving experience	Model prices	Personalisation	Standard equipment	Technical data	Additional information
--------	------------	----------------	-------------	--------------------	--------------	-----------------	--------------------	----------------	------------------------



Memory package



Seats - rear seats with folding backrests

### Safety and Assistance Systems

- 360° camera
- Active Lane Keeping Assist<sup>2</sup>
- Blind Spot Assist
- Parking package – Active Parking Assist<sup>2</sup>

### Communications and In-Car Entertainment

- Burmester® surround sound system
- MBUX Navigation Premium<sup>3</sup>
- Remote Services Premium<sup>3</sup>
- Smartphone integration<sup>4</sup>
- USB package Plus



AMG illuminated door sills with 'AMG' lettering

### Interior

- Ambient lighting in 64 colours
- AMG illuminated door sills with 'AMG' lettering and exchangeable cover
- AMG Performance steering wheel in nappa leather

- Load Compartment package
- Memory package
- Seats – 4-way lumbar support
- Seats – heated (front)

- Seats – rear seats with folding backrests<sup>1</sup>
- Steering wheel – heated
- THERMOTRONIC automatic climate control

### Trim and Upholstery

- Black piano-lacquer-look trim
- Nappa leather – black

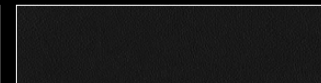

<sup>1</sup>For passengers up to 1.5 m tall    <sup>2</sup>Our driver assistance and safety systems are aids and do not relieve you of your responsibility as the driver. Please take note of the information in the Owner's Manual and the system limits which are described therein    <sup>3</sup>The connection of the communication module to the mobile phone network including the emergency call system depends on the respective network coverage and availability of network providers    <sup>4</sup>Compatible mobile phone required



# MERCEDES-AMG GT 43 PREMIUM PLUS Standard equipment highlights



In addition to/replacement of Mercedes-AMG GT 43 Premium:

**Exterior**

21" AMG forged wheels – 5-twin-spoke design, painted matt black with a high-sheen rim flange (code RWK)

AMG Night package II

Summer tyres



**OTR from 109,195<sup>1</sup>**

<sup>1</sup>The recommended on-the-road price includes the Road Fund Licence applicable to the standard model plus delivery charge (£730.00 incl. VAT), new vehicle registration fee (£55.00), fuel (£50.00 incl. VAT), and number plates (£25.00 incl. VAT). VAT is calculated at the standard rate of 20%. Some of the model features, optional extras and colours shown may not be available, or may only be available in a different specification, or at a different price

Design	Technology	Plug-in Hybrid	Model lines	Driving experience	Model prices	Personalisation	Standard equipment	Technical data	Additional information
--------	------------	----------------	-------------	--------------------	--------------	-----------------	--------------------	----------------	------------------------

**Interior**

ENERGIZING package Plus

Seats - climatized (front)

Seats - multicontour with massage function (front)

**Communications and In-Car Entertainment**

Head-up display

MBUX augmented reality for navigation

MBUX Interior Assistant

**Trim and Upholstery**

AMG carbon fibre



Nappa leather - black

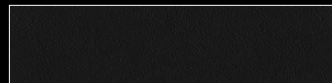



# MERCEDES-AMG GT 55 4MATIC+ PREMIUM PLUS Standard equipment highlights



No-cost option shown: obsidian black metallic (code 197)



No-cost option shown: obsidian black metallic (code 197)

## Exterior

21" AMG forged wheels – 5-twin-spoke design, aerodynamically optimised, painted matt black with a high-sheen rim flange (code RWK)

AMG brake callipers painted yellow

AMG Night package

AMG Night package II

DIGITAL LIGHT

KEYLESS-GO with seamless door handles

MAGIC VISION CONTROL

Mirror package

Panoramic fixed glass roof

Rear axle steering

Summer tyres

## Engine, Transmission and Suspension

AMG ACTIVE RIDE CONTROL suspension

AMG DYNAMIC PLUS package

AMG Track Pace



OTR from **£143,605<sup>1</sup>**

<sup>1</sup>The recommended on-the-road price includes the Road Fund Licence applicable to the standard model plus delivery charge (£730.00 incl. VAT), new vehicle registration fee (£55.00), fuel (£50.00 incl. VAT), and number plates (£25.00 incl. VAT). VAT is calculated at the standard rate of 20%. Some of the model features, optional extras and colours shown may not be available, or may only be available in a different specification, or at a different price

Design	Technology	Plug-in Hybrid	Model lines	Driving experience	Model prices	Personalisation	Standard equipment	Technical data	Additional information
--------	------------	----------------	-------------	--------------------	--------------	-----------------	--------------------	----------------	------------------------



AMG Performance steering wheel in nappa leather



Smartphone integration<sup>4</sup>



Seats - rear seats with folding backrests

### Safety and Assistance Systems

- 360° camera
- Active Lane Keeping Assist
- Blind Spot Assist
- Parking package – Active Parking Assist<sup>2</sup>

### Communications and In-Car Entertainment

- Burmester® surround sound system
- Head-up display
- MBUX Interior Assistant
- MBUX Navigation Premium<sup>3</sup>
- Remote Services Premium<sup>3</sup>
- Smartphone integration<sup>4</sup>
- USB package Plus

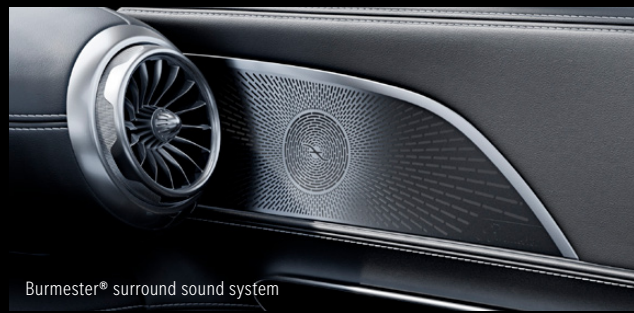

Burmester® surround sound system

### Interior

- Ambient lighting in 64 colours
- AMG illuminated door sills with 'AMG' lettering and exchangeable cover
- AMG Performance steering wheel in nappa leather
- Load Compartment package

- Memory package
- Seats – climatized (front)
- Seats – multicontour with massage function (front)

- Seats – rear seats with folding backrests<sup>1</sup>
- Steering wheel – heated
- THERMOTRONIC automatic climate control

### Trim and Upholstery

- AMG carbon fibre
- Nappa leather – black

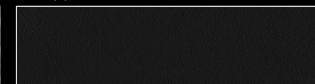

<sup>1</sup>For passengers up to 1.5 m tall <sup>2</sup>Our driver assistance and safety systems are aids and do not relieve you of your responsibility as the driver. Please take note of the information in the Owner's Manual and the system limits which are described therein

<sup>3</sup>The connection of the communication module to the mobile phone network including the emergency call system depends on the respective network coverage and availability of network providers <sup>4</sup>Compatible mobile phone required



# MERCEDES-AMG GT 63 4MATIC+ PREMIUM PLUS Standard equipment highlights



Option shown: MANUFATUR opalite white bright (code 885)

**OTR from £164,905<sup>1</sup>**



Option shown: MANUFATUR opalite white bright (code 885)

### Exterior

21" AMG forged wheels – 5-twin-spoke design, aerodynamically optimised, painted matt black with a high-sheen rim flange (code RWK)

AMG brake callipers painted yellow

AMG high-performance compound brake system

AMG Night package

AMG Night package II

DIGITAL LIGHT

KEYLESS-GO with seamless door handles

MAGIC VISION CONTROL

Mirror package

Panoramic fixed glass roof

Rear axle steering

Summer tyres

### Engine, Transmission and Suspension

AMG ACTIVE RIDE CONTROL suspension

AMG DYNAMIC PLUS package

AMG Track Pace



<sup>1</sup>The recommended on-the-road price includes the Road Fund Licence applicable to the standard model plus delivery charge (£730.00 incl. VAT), new vehicle registration fee (£55.00), fuel (£50.00 incl. VAT), and number plates (£25.00 incl. VAT). VAT is calculated at the standard rate of 20%. Some of the model features, optional extras and colours shown may not be available, or may only be available in a different specification, or at a different price

Design	Technology	Plug-in Hybrid	Model lines	Driving experience	Model prices	Personalisation	Standard equipment	Technical data	Additional information
--------	------------	----------------	-------------	--------------------	--------------	-----------------	--------------------	----------------	------------------------



Ambient lighting in 64 colours



USB package Plus



Seats - rear seats with folding backrests

**Safety and Assistance Systems**

- 360° camera
- Active Lane Keeping Assist
- Blind Spot Assist
- Parking package – Active Parking Assist<sup>2</sup>

**Communications and In-Car Entertainment**

- Burmester® surround sound system
- Head-up display
- MBUX Interior Assistant
- MBUX Navigation Premium<sup>3</sup>
- Remote Services Premium<sup>3</sup>
- Smartphone integration<sup>4</sup>
- USB package Plus



AMG illuminated door sills with 'AMG' lettering

**Interior**

- Ambient lighting in 64 colours
- AMG illuminated door sills with 'AMG' lettering and exchangeable cover
- AMG Performance steering wheel in nappa leather/ MICROCUT microfibre

- ENERGIZING package Plus
- Load Compartment package
- Memory package
- Seats – climatized (front)

- Seats – multicontour with massage function (front)
- Seats – rear seats with folding backrests<sup>1</sup>
- Steering wheel – heated
- THERMOTRONIC automatic climate control

**Trim and Upholstery**

- AMG carbon fibre
- Nappa leather – black

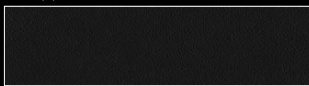

<sup>1</sup>For passengers up to 1.5 m tall    <sup>2</sup>Our driver assistance and safety systems are aids and do not relieve you of your responsibility as the driver. Please take note of the information in the Owner's Manual and the system limits which are described therein    <sup>3</sup>The connection of the communication module to the mobile phone network including the emergency call system depends on the respective network coverage and availability of network providers    <sup>4</sup>Compatible mobile phone required



# MERCEDES-AMG GT 63 S E PERFORMANCE PREMIUM PLUS Standard equipment highlights



In addition to/replacement of Mercedes-AMG GT 63 4MATIC+ Premium Plus:

**Engine, Transmission and Suspension**

150 kW electric motor for all-electric driving for up to 8 miles

Battery with a capacity of 6.1 kWh and high-performance cooling that tolerates high charging and discharging currents

Charging cable – Mode 2 cable (5 metres, straight) for domestic socket

Charging cable – Mode 3 cable (8 metres, straight) for wallbox and public charging station

**Exterior**

21" AMG forged wheels – 5-twin-spoke design, aerodynamically optimised, painted matt black with a high-sheen rim flange (code RWK)

AMG high-performance ceramic composite braking system, including bronze-painted brake callipers with 'AMG Carbon Ceramic' lettering

Summer tyres



**OTR from £180,745<sup>1</sup>**

<sup>1</sup>The recommended on-the-road price includes the Road Fund Licence applicable to the standard model plus delivery charge (£730.00 incl. VAT), new vehicle registration fee (£55.00), fuel (£50.00 incl. VAT), and number plates (£25.00 incl. VAT). VAT is calculated at the standard rate of 20%. Some of the model features, optional extras and colours shown may not be available, or may only be available in a different specification, or at a different price

Design	Technology	Plug-in Hybrid	Model lines	Driving experience	Model prices	Personalisation	Standard equipment	Technical data	Additional information
--------	------------	----------------	-------------	--------------------	--------------	-----------------	--------------------	----------------	------------------------



No-cost option shown: nappa leather in red pepper/black (code 807A)

#### Trim and Upholstery

AMG carbon fibre



Nappa leather - black

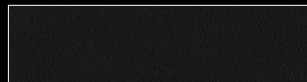



# MERCEDES-AMG GT 63 4MATIC+ ULTIMATE Standard equipment highlights



Option shown: MANUFAKTUR alpine grey solid (code 956)



Option shown: MANUFAKTUR alpine grey solid (code 956)

In addition to/replacement of Mercedes-AMG GT 63 4MATIC+ Premium Plus:

**Exterior**

21" AMG forged wheels – cross-spoke design, painted matt black with a high-sheen rim flange (code RWL)

AMG Aerodynamics package

AMG high-performance ceramic composite braking system, including bronze-painted brake callipers with 'AMG Carbon Ceramic' lettering

Summer tyres



**OTR from £175,905<sup>1</sup>**

<sup>1</sup>The recommended on-the-road price includes the Road Fund Licence applicable to the standard model plus delivery charge (£730.00 incl. VAT), new vehicle registration fee (£55.00), fuel (£50.00 incl. VAT), and number plates (£25.00 incl. VAT). VAT is calculated at the standard rate of 20%. Some of the model features, optional extras and colours shown may not be available, or may only be available in a different specification, or at a different price

Design	Technology	Plug-in Hybrid	Model lines	Driving experience	Model prices	Personalisation	Standard equipment	Technical data	Additional information
--------	------------	----------------	-------------	--------------------	--------------	-----------------	--------------------	----------------	------------------------



AMG Performance seats - no-cost option shown: nappa leather in sienna brown (code 804A)

### Interior

ENERGIZING package

Seats - AMG Performance seats

Seats - Multicontour Seat package with electrically adjustable lumbar support

ENERGIZING package



### Trim and Upholstery

AMG carbon fibre

Nappa leather - black

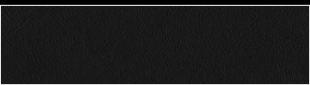



# MERCEDES-AMG GT 63 S E PERFORMANCE ULTIMATE Standard equipment highlights



No-cost option shown: selenite grey metallic (code 992)



No-cost option shown: selenite grey metallic (code 992)

In addition to/replacement of Mercedes-AMG GT 63 4MATIC+ Ultimate:

### Engine, Transmission and Suspension

150 kW electric motor for all-electric driving for up to 8 miles

Battery with a capacity of 6.1 kWh and high-performance cooling that tolerates high charging and discharging currents

Charging cable – Mode 2 cable (5 metres, straight) for domestic socket

Charging cable – Mode 3 cable (8 metres, straight) for wallbox and public charging station

### Exterior

21" AMG forged wheels – cross-spoke design, painted matt black with a high-sheen rim flange (code RWL)

Summer tyres



OTR from **£191,745<sup>1</sup>**

<sup>1</sup>The recommended on-the-road price includes the Road Fund Licence applicable to the standard model plus delivery charge (£730.00 incl. VAT), new vehicle registration fee (£55.00), fuel (£50.00 incl. VAT), and number plates (£25.00 incl. VAT). VAT is calculated at the standard rate of 20%. Some of the model features, optional extras and colours shown may not be available, or may only be available in a different specification, or at a different price

Design	Technology	Plug-in Hybrid	Model lines	Driving experience	Model prices	Personalisation	Standard equipment	Technical data	Additional information
--------	------------	----------------	-------------	--------------------	--------------	-----------------	--------------------	----------------	------------------------



AMG Performance seats - no-cost option shown: nappa leather in sienna brown (code 804A)

#### Trim and Upholstery

AMG carbon fibre



Nappa leather - black

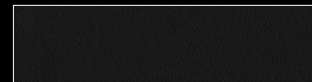



# BECOME THE AMG EXPERT

Unleash a new level of performance.

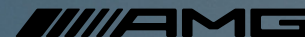

Step into the world of performance and experience the AMG brand at Mercedes-Benz World – from the powerful sound of the engines to the smell of the leather to the unmistakable design of our vehicles.

Mercedes-Benz World invites all Mercedes-AMG customers to a complimentary adrenaline-packed driving experience. Feel the sensational AMG driving performance, develop your driving skills and even try your hand at power-sliding on the Wet Skid Circle. With expert one-to-one guidance from a Driving Specialist in the passenger seat, experience every inch of our Handling Circuits, Dynamic Straight and low friction surfaces.

[Click here for more information](#)



#### TERMS AND CONDITIONS

The following customers only are eligible: The first purchaser/registered keeper of a newly registered Mercedes-AMG. The complimentary training must be booked and taken within 12 months of email receipt. The training is available Monday – Friday only (excluding bank holidays) and subject to availability. Upgrades are available for an additional cost, details upon request. Transferable to individuals who reside at the same postal address only. Mercedes-Benz UK Limited reserves the right to amend or withdraw this training experience. Attendees must hold a full UK driving licence. Attendees will be required to sign the Mercedes-Benz World Driving Risk Acknowledgement prior to undertaking the training experience.

The training experience is also subject to the Mercedes-Benz World Terms and Conditions, as applicable. Retailer demonstrator vehicles are not eligible.

<a href="#">Design</a>	<a href="#">Technology</a>	<a href="#">Plug-in Hybrid</a>	<a href="#">Model lines</a>	<a href="#">Driving experience</a>	<a href="#">Model prices</a>	<a href="#">Personalisation</a>	<a href="#">Standard equipment</a>	<a href="#">Technical data</a>	<a href="#">Additional information</a>
------------------------	----------------------------	--------------------------------	-----------------------------	------------------------------------	------------------------------	---------------------------------	------------------------------------	--------------------------------	--

[Book a test drive](#)[Find your Mercedes-AMG GT](#)[Find a Showroom](#)

# MODEL PRICES



Model line	Engine	Transmission	CO <sub>2</sub> WLTP <sup>1*</sup>	Basic RRP excl. VAT (€)	Total RRP incl. VAT (€)	Road Fund Licence (€) <sup>2</sup> WLTP	Rec. OTR price (€) <sup>3</sup> WLTP	P11D value (€)	BiK tax rate 2024/25 (%) <sup>2</sup>
<b>Premium</b>									
Mercedes-AMG GT 43	Petrol - 1,991cc, 4-cylinder, 421hp/310 kW	AMG SPEEDSHIFT MCT 9-speed sports automatic transmission	235	82,079.17	98,495.00	2,340.00	<b>101,695.00</b>	99,300.00	37
<b>Premium Plus</b>									
Mercedes-AMG GT 43	Petrol - 1,991cc, 4-cylinder, 421hp/310 kW	AMG SPEEDSHIFT MCT 9-speed sports automatic transmission	235	88,329.17	105,995.00	2,340.00	<b>109,195.00</b>	106,800.00	37
Mercedes-AMG GT 55 4MATIC+	Petrol - 3,982cc, 8-cylinder, 476hp/350 kW	AMG SPEEDSHIFT MCT 9-speed sports automatic transmission	319	116,666.67	140,000.00	2,745.00	<b>143,605.00</b>	140,805.00	37
Mercedes-AMG GT 63 4MATIC+	Petrol - 3,982cc, 8-cylinder, 585hp/430 kW	AMG SPEEDSHIFT MCT 9-speed sports automatic transmission	319	134,416.67	161,300.00	2,745.00	<b>164,905.00</b>	162,105.00	37
Mercedes-AMG GT 63 S E PERFORMANCE	Petrol - 3,982cc, 8-cylinder, 612hp/450 kW Electric motor - 204hp/150 kW	AMG SPEEDSHIFT MCT 9-speed sports automatic transmission	188	149,000.00	178,800.00	1,085.00	<b>180,745.00</b>	179,605.00	37
<b>Ultimate</b>									
Mercedes-AMG GT 63 4MATIC+	Petrol - 3,982cc, 8-cylinder, 585hp/430 kW	AMG SPEEDSHIFT MCT 9-speed sports automatic transmission	319	143,583.33	172,300.00	2,745.00	<b>175,905.00</b>	173,105.00	37
Mercedes-AMG GT 63 S E PERFORMANCE	Petrol - 3,982cc, 8-cylinder, 612hp/450 kW Electric motor - 204hp/150 kW	AMG SPEEDSHIFT MCT 9-speed sports automatic transmission	188	158,166.67	189,800.00	1,085.00	<b>191,745.00</b>	190,605.00	37

<sup>1</sup>The indicated values were determined according to the prescribed measurement method - Worldwide Harmonised Light Vehicle Test Procedure (WLTP). Figures shown may include options which are not available in the UK. <sup>2</sup>Figures shown are for comparability purposes; only compare with other cars tested to the same technical procedures. Figures may not reflect real life driving results, which will depend upon a number of factors including factory-fitted options, accessories fitted (post registration), variations in weather, driving styles and vehicle load. Further information about the test used to establish fuel consumption and CO<sub>2</sub> figures can be found at <http://www.mercedes-benz.co.uk/WLTP>. <sup>3</sup>A different first year rate of Vehicle Excise Duty (Road Fund Licence) applies for new cars. Please refer to page 61 for the relevant rate for the second and subsequent years. <sup>4</sup>The recommended on-the-road price includes the Road Fund Licence applicable to the standard model plus delivery charge (£665.00 incl. VAT), new vehicle registration fee (£55.00), fuel (£50.00 incl. VAT), and number plates (£25.00 incl. VAT). VAT is calculated at the standard rate of 20%. Some of the model features, optional extras and colours shown may not be available, or may only be available in a different specification, or at a different price.



# PERSONALISATION Overview

Paints »



Wheels »



Upholstery »



Trim »

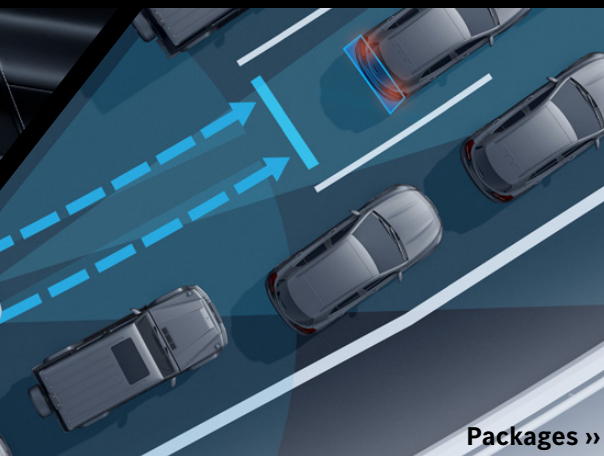

Packages »

# COLOUR OPTIONS

Non-metallic and metallic paints

No-cost option



**197 obsidian black metallic**

All models

**Total RRP incl. VAT**

-



**922 high-tech silver metallic**

All models

**Total RRP incl. VAT**

-



**992 selenite grey metallic**

All models

**Total RRP incl. VAT**

-



**914 sun yellow non-metallic**

All models

**Total RRP incl. VAT**

-



**970 spectral blue metallic**

All models

**Total RRP incl. VAT**

-

Please note that, owing to limitations of on-screen representation, paint colours may differ from those shown



# COLOUR OPTIONS MANUFAKTUR paints

Cost option



**885 MANUFAKTUR opalite white bright**

All models

**Total RRP incl. VAT**

**£1,600.00**



**956 MANUFAKTUR alpine grey solid**

All models

**Total RRP incl. VAT**

**£4,000.00**



**993 MANUFAKTUR patagonia red bright**

All models

**Total RRP incl. VAT**

**£1,600.00**

Please note that, owing to limitations of on-screen representation, paint colours may differ from those shown

# COLOUR OPTIONS

 MANUFAKTUR and AMG magno paints

Cost option



**593 MANUFAKTUR spectral blue magno<sup>1</sup>**

All models

**Total RRP incl. VAT**

**£6,300.00**



**659 MANUFAKTUR opalite white magno<sup>1</sup>**

All models

**Total RRP incl. VAT**

**£6,300.00**



**964 MANUFAKTUR hyper blue magno<sup>1</sup>**

All models

**Total RRP incl. VAT**

**£6,300.00**



**376 AMG green hell magno<sup>1</sup>**

All models

**Total RRP incl. VAT**

**£7,795.00**

Please note that, owing to limitations of on-screen representation, paint colours may differ from those shown

<sup>1</sup>MANUFAKTUR magno matt paint finishes require extra care. Please refer to the Owner's Manual for instructions



# UPHOLSTERY Nappa leather<sup>1</sup>

● Standard   □ No-cost option   — Not available



**801A Nappa leather<sup>1</sup> – black**  
Black roof liner

- Premium
- Premium Plus
- Ultimate<sup>2</sup>



**804A Nappa leather<sup>1</sup> – sienna brown/black**  
Black roof liner

- Premium
- Premium Plus
- Ultimate<sup>2</sup>

<sup>1</sup>100% of seat upholstery is pure leather

<sup>2</sup>AMG Performance seats standard on Mercedes-AMG GT 63 4MATIC+ Ultimate

# UPHOLSTERY Nappa leather<sup>1</sup>

● Standard   □ No-cost option   — Not available



**807A Nappa leather<sup>1</sup> – red pepper/black**  
Black roof liner

- Premium
- Premium Plus
- Ultimate<sup>2</sup>



**808A Nappa leather<sup>1</sup> – sage grey/black**  
Black roof liner

- Premium
- Premium Plus
- Ultimate<sup>2</sup>

<sup>1</sup>100% of seat upholstery is pure leather

<sup>2</sup>AMG Performance seats standard on Mercedes-AMG GT 63 4MATIC+ Ultimate



# UPHOLSTERY MANUFAKTUR nappa leather<sup>1</sup> and Nappa leather<sup>1</sup>/MICROCUT microfibre

● Standard   □ No-cost option   — Not available



**824A MANUFAKTUR nappa leather<sup>1</sup> - truffle brown**  
Black roof liner

- Premium
- Premium Plus
- Ultimate<sup>3</sup>



**825A MANUFAKTUR nappa leather<sup>1</sup> - crystal white/black<sup>2</sup>**  
Neva grey roof liner

- Premium
- Premium Plus
- Ultimate<sup>3</sup>

<sup>1</sup>100% of seat upholstery is pure leather

<sup>2</sup>Only in conjunction with MANUFAKTUR roof liner in neva grey MICROCUT microfibre (code 69U)

<sup>3</sup>AMG Performance seats standard on Mercedes-AMG GT 63 4MATIC+ Ultimate

# TRIM

● Standard   □ No-cost option   — Not available



**H80** Black piano-lacquer look

Premium	●
Premium Plus	—
Ultimate	—



**H73** AMG carbon fibre

Premium	—
Premium Plus	●
Ultimate	●



**H97** Open-pore grey birch wood

Premium	—
Premium Plus	□
Ultimate	□



**H98** Ship's deck open-pore brown ash wood with aluminium lines

Premium	—
Premium Plus	□
Ultimate	□



# COMBINATION OPTIONS

— Not available    Roof liner available in:  61U black     69U neva grey

		Interior upholstery colours					
		Premium, Premium Plus and Ultimate					
		801A Nappa leather <sup>1</sup> - black	804A Nappa leather <sup>1</sup> - sienna brown/black	807A Nappa leather <sup>1</sup> - red pepper/black	808A Nappa leather <sup>1</sup> - sage grey/black	824A MANUFAKTUR nappa leather <sup>1</sup> - truffle brown	825A MANUFAKTUR nappa leather <sup>1</sup> - crystal white/black
Exterior paint colours	197 obsidian black metallic						
	914 sun yellow metallic			—	—		
	922 high-tech silver metallic						
	970 spectral blue metallic			—	—		
	992 selenite grey metallic						
	885 MANUFAKTUR opalite white bright						
	956 MANUFAKTUR alpine grey solid						
	993 MANUFAKTUR patagonia red bright		—	—	—	—	
	593 MANUFAKTUR spectral blue magno <sup>4</sup>			—	—		
	659 MANUFAKTUR opalite white magno <sup>4</sup>						
	964 MANUFAKTUR hyper blue magno <sup>4</sup>			—	—		
	376 AMG green hell magno <sup>4</sup>			—	—		

<sup>1</sup>100% of seat upholstery is pure leather

<sup>2</sup>With yellow stitching

<sup>3</sup>With red stitching

<sup>4</sup>MANUFAKTUR magno matt paint finishes require extra care. Please refer to the Owner's Manual for instructions

# WHEELS

● Standard   □ No-cost option   — Not available



20" AMG wheels – multi-spoke design, painted titanium grey with a high-shine finish, with 265/40 (front) and 295/35 (rear) R20 tyres (code RVM)

Premium	●
Premium Plus	—
Ultimate <sup>2</sup>	—



21" AMG forged wheels – 5-twin-spoke design, aerodynamically optimised, painted matt black with a high-shine rim flange, 295/30 (front) and 305/30 (rear) R21 tyres (code RWK)

Premium	—
Premium Plus	●
Ultimate <sup>2</sup>	—



21" AMG forged wheels – cross-spoke design, painted matt black with a high-shine rim flange, 295/30 (front) and 305/30 (rear) R21 tyres (code RWL)

Premium	—
Premium Plus	—
Ultimate <sup>2</sup>	●

Ceramic brakes are standard on Mercedes-AMG GT 63 S E PERFORMANCE models



# WHEELS

No-cost option     Not available



**21" AMG forged wheels - 10-twin-spoke design, painted himalayas grey with a high-sheen finish, 295/30 (front) and 305/30 R21 tyres (rear) (code RWD)**

Premium	—
Premium Plus	<input type="checkbox"/>
Ultimate <sup>2</sup>	<input type="checkbox"/>



**21" AMG forged wheels - 10-twin-spoke design, painted matt black with a high-sheen rim flange, 295/30 (front) and 305/30 R21 tyres (rear) (code RWE)**

Premium	—
Premium Plus	<input type="checkbox"/>
Ultimate <sup>2</sup>	<input type="checkbox"/>



**21" AMG forged wheels - 5-twin-spoke design, aerodynamically optimised, painted tantalite grey with a high-sheen finish, 295/30 (front) and 305/30 R21 tyres (rear) (code RWI)**

Premium	—
Premium Plus	<input type="checkbox"/>
Ultimate <sup>2</sup>	<input type="checkbox"/>

Ceramic brakes are standard on Mercedes-AMG GT 63 S E PERFORMANCE models



# DRIVING ASSISTANCE PACKAGE

The Driving Assistance package<sup>1</sup> contains a range of highly intelligent features to help you stay safe on the road – by making the drive more effortless, by warning of danger, and by taking steps to protect you in an emergency.

## Driving Assistance package<sup>1</sup> (code P20)

Active Blind Spot Assist

Active Distance Assist DISTRONIC

Active Steering Assist

Active Stop-and-Go Assist

Evasive Steering Assist

PRE-SAFE<sup>®</sup> PLUS and PRE-SAFE<sup>®</sup> Impulse Side

**Total incl. VAT £2,500.00**

<sup>1</sup>Our driver assistance and safety systems are aids and do not relieve you of your responsibility as the driver. Please take note of the information in the Owner's Manual and the system limits which are described therein



[Book a test drive](#)[Find your Mercedes-AMG GT](#)[Find a Showroom](#)

# STANDARD EQUIPMENT

● Standard    – Not available

	GT 43 Premium	GT 43 Premium Plus	GT 63 Premium Plus	GT 63 S E PERF. Prem. Plus	GT 63 S E PERF. Ultimate	GT 63 Ultimate	GT 63 S E PERF. Ultimate		GT 43 Premium	GT 43 Premium Plus	GT 63 Premium Plus	GT 63 S E PERF. Prem. Plus	GT 63 S E PERF. Ultimate	GT 63 Ultimate	GT 63 S E PERF. Ultimate
<b>Engine, Transmission and Suspension</b>															
AMG ACTIVE RIDE CONTROL suspension	–	–	●	●	●	●	●	AMG high-performance ceramic composite braking system	–	–	–	–	●	●	●
AMG DYNAMIC PLUS package – ‘RACE’ drive program, AMG dynamic engine mounts, AMG rear axle locking differential (electronic) and suspension lowering by 10 mm	–	–	●	●	●	●	●	AMG high-performance compound brake system	●	●	●	●	–	–	–
AMG electronic rear-axle limited-slip differential	–	–	●	●	–	●	–	AMG light display – the projector fitted in the side skirts casts ‘AMG’ lettering onto the asphalt	●	●	●	●	●	●	●
AMG RIDE CONTROL suspension	●	●	–	–	–	–	–	AMG Night package – front splitter in high-gloss black, A-wing trim strip in high-gloss black, front wing trim element in high-gloss black, AMG outside mirror housing in high-gloss black, side sill panel with trim strip in high-gloss black, rear apron insert in high-gloss black and twin tailpipe trims in black chrome	●	●	●	●	●	●	●
AMG SPEEDSHIFT MCT 9-speed sports automatic transmission	●	●	●	●	●	●	●	AMG Night package II – radiator grille in black chrome, typography on the front wings and rear in black chrome and Mercedes star at the rear in black chrome	–	●	●	●	●	●	●
AMG Track Pace – transform your AMG vehicle into your virtual race engineer. With the aid of lap, sector and acceleration times plus selected live telemetry data you can specifically analyse and improve your driving skills on cordoned-off tracks	●	●	●	●	●	●	●	AMG Real Performance Sound	●	●	●	●	●	●	●
Charging cable – Mode 2 cable (5 metres, straight) for domestic socket	–	–	–	–	●	–	●	Brakes – bronze-painted brake callipers with ‘AMG Carbon Ceramic’ lettering	–	–	–	–	●	●	●
Charging cable – Mode 3 cable (8 metres, straight) for wallbox and public charging station	–	–	–	–	●	–	●	Brakes – silver-painted AMG brake callipers	●	●	–	–	–	–	–
Charging system – AC charging 3.7 kW	–	–	–	–	●	–	●	Brakes – yellow-painted AMG brake callipers	–	–	●	●	–	–	–
Cruise control	●	●	●	●	●	●	●	KEYLESS-GO starting function	●	●	●	●	●	●	●
Lift system, front axle	–	–	–	●	●	●	–	KEYLESS-GO with seamless doorhandles	●	●	●	●	●	●	●
Pre-installation for Remote and Charging Services	–	–	–	–	●	–	●	Headlamps – DIGITAL LIGHT	●	●	●	●	●	●	●
<b>Exterior</b>															
Active rear spoiler (retractable)	●	●	●	●	●	–	–	MAGIC VISION CONTROL – highly efficient windscreen wiper system comprising control unit, position sensor, electric pump and distributor rail; heating for wiper blades, washer fluid reservoir and washer fluid hoses; automatic intermittent wipe with rain sensor and Practical one-touch wash function	●	●	●	●	●	●	●
AMG Aerodynamics package – front apron with larger flics on the air intakes and wheel arches in high-gloss black, rear apron with flics on the side air outlets in high-gloss black, diffuser attachment at the rear in high-gloss black and active aerodynamic profile made of carbon in the underbody in front of the engine	–	–	–	–	–	●	●								

[Book a test drive](#)[Find your Mercedes-AMG GT](#)[Find a Showroom](#)

# STANDARD EQUIPMENT

● Standard – Not available

## Exterior (continued)

	GT 43 Premium	GT 43 Premium Plus	GT 55 Premium Plus	GT 63 S E PERF. Prem. Plus	GT 63 S E PERF. Ultimate	GT 63 Ultimate
Mirror package	●	●	●	●	●	●
Panoramic fixed glass roof	●	●	●	●	●	●
Privacy glass	●	●	●	●	●	●
Radiator grille with fins painted black	●	●	●	●	●	●

## Wheels

	GT 43 Premium	GT 43 Premium Plus	GT 55 Premium Plus	GT 63 S E PERF. Prem. Plus	GT 63 S E PERF. Ultimate	GT 63 Ultimate
20" AMG wheels – multi-spoke design, painted titanium grey with a high-sheen finish, with 265/40 (front) and 295/35 (rear) R20 tyres (code RVM)	●	–	–	–	–	–
21" AMG forged wheels – 5 twin-spoke design, aerodynamically optimised, painted matt black with a high-sheen rim flange, 295/30 (front) and 305/30 (rear) R21 tyres (code RWK)	–	●	●	●	●	–
21" AMG forged wheels – cross-spoke design, painted matt black with a high-sheen rim flange, 295/30 (front) and 305/30 (rear) R21 tyres (code RWL)	–	–	–	–	●	●
Summer tyres	●	●	●	●	●	●

## Interior

	GT 43 Premium	GT 43 Premium Plus	GT 55 Premium Plus	GT 63 S E PERF. Prem. Plus	GT 63 S E PERF. Ultimate	GT 63 Ultimate
Ambient lighting – 64 colours	●	●	●	●	●	●
AMG illuminated door sills with 'AMG' lettering and exchangeable cover	●	●	●	●	●	●
Cup holder – twin, front	●	●	●	●	●	●
ENERGIZING AIR CONTROL – monitors the air quality with the help of air quality and fine particle sensors. A two-stage filter concept reduces fine particle and the majority of other inhalable pollutants. Depending on the value measured, your vehicle switches intelligently between fresh air and air-recirculation mode	–	–	–	●	●	●
ENERGIZING package – comfort programmes 'Warmth', 'Joy', 'Well-being', 'Refresh' and 'Vitality', ENERGIZING COACH with individual programme recommendations	–	–	–	–	●	●

\*For passengers up to 1.5 m tall

	GT 43 Premium	GT 43 Premium Plus	GT 55 Premium Plus	GT 63 S E PERF. Prem. Plus	GT 63 S E PERF. Ultimate	GT 63 Ultimate
ENERGIZING package Plus – comfort programmes 'Warmth', 'Joy', 'Well-being', 'Refresh' and 'Vitality', ENERGIZING COACH with individual programme recommendations, multicontour seats and seat climate control for driver and front passenger	–	●	●	●	●	–
Load Compartment package	●	●	●	●	●	●
Memory package	●	●	●	●	●	●
Seats – 4-way lumbar support	●	–	–	–	–	–
Seats – AMG Performance seats	–	–	–	–	–	●
Seats – climatized (front)	–	●	●	●	●	●
Seats – heated (front)	●	–	–	–	–	–
Seats – multicontour with massage function (front)	–	●	●	●	●	–
Seats – Multicontour Seat package with electrically adjustable lumbar support	–	–	–	–	–	●
Seats – rear seats with folding backrests <sup>1</sup>	●	●	●	●	●	●
Socket in boot	●	●	●	●	●	●
THERMOTRONIC automatic climate control	●	●	●	●	●	●

## Steering

	GT 43 Premium	GT 43 Premium Plus	GT 55 Premium Plus	GT 63 S E PERF. Prem. Plus	GT 63 S E PERF. Ultimate	GT 63 Ultimate
Rear-axle steering	–	–	●	●	●	●
Steering wheel – AMG Performance steering wheel in nappa leather	●	●	●	–	–	–
Steering wheel – AMG Performance steering wheel in nappa leather/MICROCUT microfibre	–	–	–	●	●	●
Steering wheel – AMG steering wheel buttons	●	●	●	●	●	●
Steering wheel – heated	●	●	●	●	●	●



[Book a test drive](#)[Find your Mercedes-AMG GT](#)[Find a Showroom](#)

# STANDARD EQUIPMENT

● Standard – Not available

	GT 43 Premium	GT 43 Premium Plus	GT 55 Premium Plus	GT 63 S E PERF. Prem. Plus	GT 63 S E PERF. Ultimate	GT 63 Ultimate
<b>Paint, Trim and Upholstery</b>						
Paint – metallic	●	●	●	●	●	●
Roof liner – MANUFAKTUR roof liner in black MICROCUT microfibre	●	●	●	●	●	●
Trim – AMG carbon fibre	–	●	●	●	●	●
Trim – black piano-lacquer look	●	–	–	–	–	–
Upholstery – nappa leather in black	●	●	●	●	●	●

## Safety and Assistance Systems

360° camera	●	●	●	●	●	●
Active Brake Assist <sup>1</sup> with intersection start-off function	●	●	●	●	●	●
Active Lane Keeping Assist <sup>1</sup>	●	●	●	●	●	●
Blind Spot Assist	●	●	●	●	●	●
Child presence detection	●	●	●	●	●	●
GUARD 360° vehicle protection Plus <sup>2</sup>	●	●	●	●	●	●
Mercedes-Benz emergency call system <sup>2,3</sup>	●	●	●	●	●	●
Parking package – Active Parking Assist <sup>1</sup>	●	●	●	●	●	●
PRE-SAFE® system	●	●	●	●	●	●
Pedestrian protection	●	●	●	●	●	●
Traffic Sign Assist	●	●	●	●	●	●
Tyres – tyre pressure monitoring system	●	●	●	●	●	●

## Communications and In-Car Entertainment

	GT 43 Premium	GT 43 Premium Plus	GT 55 Premium Plus	GT 63 S E PERF. Prem. Plus	GT 63 S E PERF. Ultimate	GT 63 Ultimate
<b>Communications and In-Car Entertainment</b>						
Burmester® surround sound system	●	●	●	●	●	●
Central display – high-resolution 11.9-inch display	●	●	●	●	●	●
Driver display – high-resolution 12.3-inch LCD colour display	●	●	●	●	●	●
Head-up display	–	●	●	●	●	●
MBUX augmented reality for navigation	–	●	●	●	●	●
MBUX Interior Assistant	–	●	●	●	●	●
MBUX Navigation Premium <sup>2</sup>	●	●	●	●	●	●
Remote Services Premium <sup>2</sup>	●	●	●	●	●	●
Smartphone integration <sup>4</sup> including Apple CarPlay® and Android Auto™	●	●	●	●	●	●
USB package Plus – two USB-C ports in the front oddments tray and two USB-C ports below the centre armrest	●	●	●	●	●	●
Wireless charging system (front) for mobile devices <sup>4</sup>	●	●	●	●	●	●

<sup>1</sup>Our driver assistance and safety systems are aids and do not relieve you of your responsibility as the driver. Please take note of the information in the Owner's Manual and the system limits which are described therein of network providers

<sup>2</sup>Please be aware Mercedes-Benz emergency call system comes as standard for the first 10 years of the vehicle's lifecycle

<sup>3</sup>Compatible mobile phone required. Please check [www.mercedes-benz-mobile.com](http://www.mercedes-benz-mobile.com) for details or contact your local Mercedes-Benz Agent for further information

<sup>4</sup>The connection of the communication module to the mobile phone network including the emergency call system depends on the respective network coverage and availability

[Book a test drive](#)[Find your Mercedes-AMG GT](#)[Find a Showroom](#)

# TECHNICAL DATA

- Standard

Model	Mercedes-AMG GT 43	Mercedes-AMG GT 55 4MATIC+	Mercedes-AMG GT 63 4MATIC+	Mercedes-AMG GT 63 S E PERFORMANCE
<b>Engine</b>				
Total displacement	cc 1,991	3,982	3,982	3,982
Arrangement/cylinders/valves	in-line/4/16	V/8/32	V/8/32	V/8/32
Power <sup>1</sup>	hp (kW) at rpm			
Combustion engine	421 (310)/6,750	476 (350)/6,500	585 (430)/6,500	612 (450)/5,500–6,500
Electric motor	–	–	–	204 (150)
System output	–	–	–	816 (600)
Torque <sup>1</sup>	Nm at rpm			
Combustion engine	500/5,000	700/2,250–4,500	800/2,350–5,000	850/2,500–4,500
Electric motor	–	–	–	320
Compression ratio	10.0:1	8.6:1	8.6:1	8.6:1
Electric range – WLTP <sup>2</sup>	miles	–	–	8
Range power consumption combined <sup>2,3</sup>	Wh/km	–	–	339
Battery type (usable)	kWh	–	–	Lithium-ion (4.8)
Charging time				
Wallbox (3.7 kW AC) 25–100% <sup>4</sup>	–	–	–	3 hrs 40 mins
Emissions standard	Euro 6e	Euro 6e	Euro 6e	Euro 6e
<b>Transmission</b>				
AMG SPEEDSHIFT MCT 9-speed sports auto. transmission	●	●	●	●

<sup>1</sup>Figures according to Directive 80/1269/EEC in the currently applicable version   <sup>2</sup>The indicated values were determined according to the prescribed measurement method – Worldwide Harmonised Light Vehicle Test Procedure (WLTP). Figures shown may include options which are not available in the UK. For Plug-in Hybrid Electric Vehicle (PHEV) figures determined with the battery fully charged, using a combination of both battery power and fuel. These models require mains electricity for charging   <sup>3</sup>The certified electrical consumption is generally determined at maximum AC charging capacity using a Mode 3 cable. It is therefore recommended that vehicles with a HV battery preferably be charged at a wallbox or an AC charging station with a Mode 3 cable in order to achieve shorter charging times and improved charging efficiency   <sup>4</sup>Specified voltage and current values refer to network infrastructure and can be limited by the vehicle. Times are from 25–100% charge using a wallbox (three-phase) or standard socket (single-phase)



[Book a test drive](#)[Find your Mercedes-AMG GT](#)[Find a Showroom](#)

# TECHNICAL DATA

Model		Mercedes-AMG GT 43	Mercedes-AMG GT 55 4MATIC+	Mercedes-AMG GT 63 4MATIC+	Mercedes-AMG GT 63 S E PERFORMANCE
<b>Performance</b>					
Acceleration 0–62 mph	sec	4.6	3.9	3.2	2.8
Top speed	mph	174	183	196 <sup>5</sup>	199 <sup>5</sup>
<b>Weights and capacities</b>					
Kerb weight <sup>6</sup>	kg	1,974	2,121	2,121	2,340
Perm. Gross Vehicle Weight	kg	2,005	2,160	2,160	2,365
Boot capacity	l	321	321	321	182
Fuel tank capacity/of which reserve	l	70/10	70/10	70/10	70/10
Turning circle	m	13.16	12.57	12.57	12.57
<b>Fuel consumption<sup>7,8,9</sup></b>					
Combined (consumption dependent on chosen optional equipment)	l/100 km	10.3	14.0	14.0	8.2
	mpg	27.4	20.2	20.2	34.5
<b>Insurance</b>					
Group rating		tba	tba	50E	50E

Insurance ratings may vary depending on model line and specification.

<sup>5</sup>Electronically limited <sup>6</sup>Mass of the vehicle in running order with at least 90% full fuel tank, plus the mass of the driver (estimated by law at 75 kg), fuel and fluids, equipped with the standard equipment as specified by the manufacturer as well as, where applicable, the mass of the body, cab, trailer coupling and spare wheel(s) as well as tools. Optional extras, additional equipment and accessories can influence the weight, residual payload, rolling resistance, aerodynamics, etc., and therefore also affect the consumption/CO<sub>2</sub> values <sup>7</sup>All figures are based on a standard specification with the smallest tyre size <sup>8</sup>The choice of wheels and transmission may affect CO<sub>2</sub> emissions and corresponding Road Fund Licence <sup>9</sup>The indicated values were determined according to the prescribed measurement method - Worldwide Harmonised Light Vehicle Test Procedure (WLTP). Figures shown may include options which are not available in the UK

## Mercedes-AMG GT 43

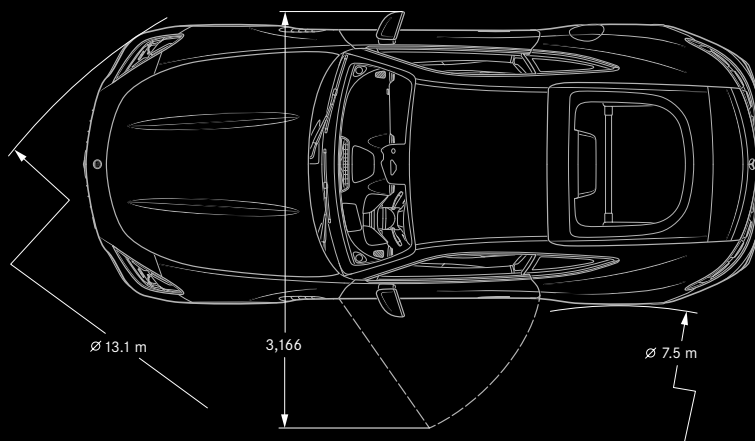
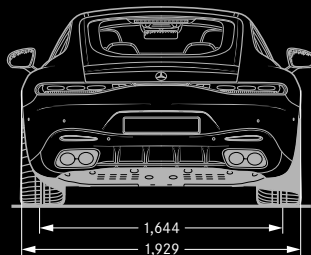
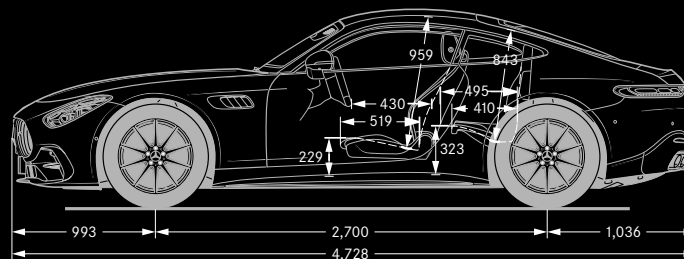
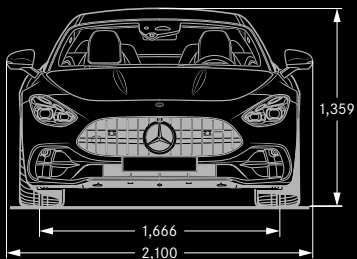

All measurements in millimetres. The dimensions shown are mean values and apply to standard-specification, unladen vehicles

Design	Technology	Plug-in Hybrid	Model lines	Driving experience	Model prices	Personalisation	Standard equipment	Technical data	Additional information
--------	------------	----------------	-------------	--------------------	--------------	-----------------	--------------------	----------------	------------------------



## Mercedes-AMG GT 55 4MATIC+, Mercedes-AMG GT 63 4MATIC+ and Mercedes-AMG GT 63 S E PERFORMANCE

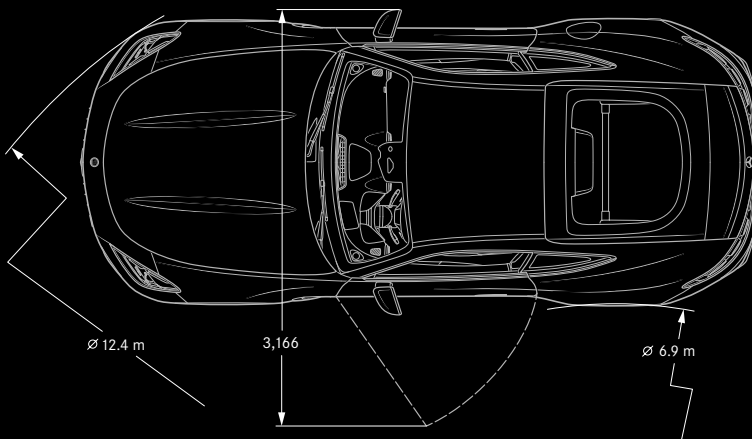
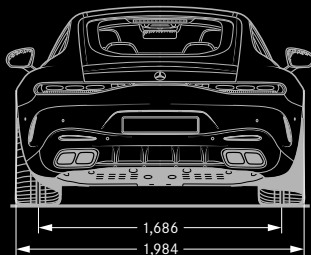
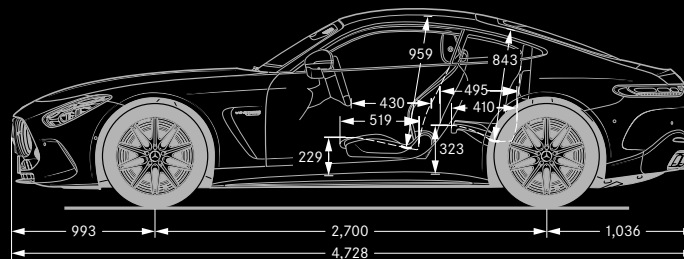
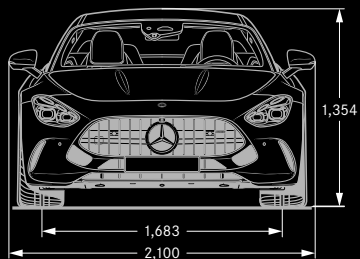

All measurements in millimetres. The dimensions shown are mean values and apply to standard-specification, unladen vehicles

Design	Technology	Plug-in Hybrid	Model lines	Driving experience	Model prices	Personalisation	Standard equipment	Technical data	Additional information
--------	------------	----------------	-------------	--------------------	--------------	-----------------	--------------------	----------------	------------------------

# ROAD FUND LICENCE

All road vehicle registrations are subject to Vehicle Excise Duty (Road Fund Licence), which varies in accordance with the vehicle's CO<sub>2</sub> emissions. A first year rate for each taxation band will apply. The table below shows the bands (A-M) created by the DVLA and the corresponding Road Fund Licence. CO<sub>2</sub> emissions and the relevant Excise Duty are shown on the model pricing pages.

Band	CO <sub>2</sub> emissions (g/km)	First year rate petrol and RDE2 diesel (£)	First year rate alternative fuel (£)	Electric vehicles		Alternative fuel vehicles		Petrol/diesel vehicles	
				Standard rate (£)	Premium rate (£) <sup>1</sup>	Standard rate (£)	Premium rate (£) <sup>1</sup>	Standard rate (£)	Premium rate (£) <sup>1</sup>
A	0	0.00	0.00	0.00	0.00	0.00	0.00	0.00	0.00
B	1 to 50	10.00	0.00	0.00	0.00	180.00	590.00	190.00	600.00
C	51 to 75	30.00	20.00	0.00	0.00	180.00	590.00	190.00	600.00
D	76 to 90	135.00	125.00	0.00	0.00	180.00	590.00	190.00	600.00
E	91 to 100	175.00	165.00	0.00	0.00	180.00	590.00	190.00	600.00
F	101 to 110	195.00	185.00	0.00	0.00	180.00	590.00	190.00	600.00
G	111 to 130	220.00	210.00	0.00	0.00	180.00	590.00	190.00	600.00
H	131 to 150	270.00	260.00	0.00	0.00	180.00	590.00	190.00	600.00
I	151 to 170	680.00	670.00	0.00	0.00	180.00	590.00	190.00	600.00
J	171 to 190	1,095.00	1,085.00	0.00	0.00	180.00	590.00	190.00	600.00
K	191 to 225	1,650.00	1,640.00	0.00	0.00	180.00	590.00	190.00	600.00
L	226 to 255	2,340.00	2,330.00	0.00	0.00	180.00	590.00	190.00	600.00
M	over 255	2,745.00	2,735.00	0.00	0.00	180.00	590.00	190.00	600.00



Some of the model features, optional extras and colours shown may not be available, or may only be available in a different specification, or at a different price  
<sup>1</sup>Premium rate only applicable to vehicles where the list price is over £40,000 including any factory-fitted options, standard UK delivery charge and VAT



# SERVICES AND INSURANCE

## Mercedes-Benz Service Plans

We believe that servicing and repair costs should be as flexible and affordable as possible for your Mercedes-AMG GT, which is why we offer a choice of Service Plans to make it easy to budget for all your servicing, MOT and repair costs. It spreads your bills into manageable monthly payments based on whether you have a new or used Mercedes-Benz.

- **ServiceCare** – guarantees the price of parts and labour for up to four services and safeguards against any inflationary influences. It also covers your annual MOT fees depending on the age of your vehicle when you take your plan out.
- **CompleteCare** – our most comprehensive plan covering all your servicing, MOT, wear & tear needs as well as Extended Warranty once your vehicle turns four years old.
- **Extended Warranty** – protect yourself against sudden or unexpected repair costs after your initial warranty period has ended after three years. There are three policy options to choose from: 12-month, 24-month or a monthly pay-as-you-go option.

[› Click here for more information](#)

## Warranty and breakdown cover

Every Mercedes-Benz comes with a three-year unlimited mileage warranty against manufacturing or material defects<sup>1</sup> and up to 30 years warranty against perforation due to corrosion from the inside out.<sup>2</sup> What's more, it's also covered by Mercedes-Benz Roadside Assistance – a unique package comprising up to 30 years pan-European breakdown assistance.<sup>2</sup>

<sup>1</sup>Applies to vehicles sold by Mercedes-Benz in the UK to its franchised Mercedes-Benz Agents  
Mercedes-Benz Motor Insurance is underwritten by Aviva Insurance UK Limited. Credit provided, subject to status, by Mercedes-Benz Financial Services UK Ltd, MK15 8BA

<sup>2</sup>Subject to full Terms and Conditions, dependent on date of registration, available upon request

<sup>3</sup>Terms and Conditions apply. We are an independent intermediary dealing with selected insurers in respect of annual insurance

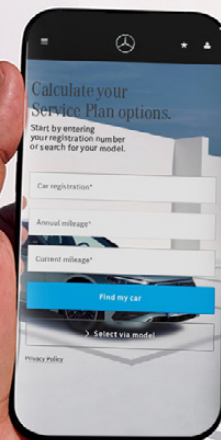

## Motor Insurance

We know that once you have chosen your Mercedes-Benz you can't wait to drive it – that's why we created First Cover<sup>3</sup>. It gives you 7 days' free comprehensive Motor Insurance when you buy a new or used vehicle from a Mercedes-Benz Agent. We will also send you a quote for annual cover, so you can enjoy the same peace of mind all year round.

[› Apply for First Cover](#)





Effective from January 2025 Production. Information correct at time of publication 10.10.2024.

Prices and specifications are subject to change without prior notice.

MBC192PL/1024 MY805.5

Mercedes-Benz Cars UK Limited, Tongwell, Milton Keynes, MK15 8BA. Company number 2448457 [www.mercedes-benz.co.uk](http://www.mercedes-benz.co.uk)

