



The G-Class

Effective from September 2023 Production.

Mercedes-Benz





Book a test drive



Find your G-Class



Find a Showroom



Some of the model features, optional extras and colours shown may not be available, or may only be available in a different specification.



Design	Technology	Model line	Model prices	Mercedes-AMG	Mercedes-AMG prices	Personalisation	Standard equipment	Genuine accessories	Technical data	Additional information
--------	------------	------------	--------------	--------------	---------------------	-----------------	--------------------	---------------------	----------------	------------------------

[Book a test drive](#)[Find your G-Class](#)[Find a Showroom](#)

Some of the model features, optional extras and colours shown may not be available, or may only be available in a different specification.

Design	Technology	Model line	Model prices	Mercedes-AMG	Mercedes-AMG prices	Personalisation	Standard equipment	Genuine accessories	Technical data	Additional information
------------------------	----------------------------	----------------------------	------------------------------	------------------------------	-------------------------------------	---------------------------------	------------------------------------	-------------------------------------	--------------------------------	--



Book a test drive



Find your G-Class



Find a Showroom



G-Class

Technology

Design	Technology	Model line	Model prices	Mercedes-AMG	Mercedes-AMG prices	Personalisation	Standard equipment	Genuine accessories	Technical data	Additional information
------------------------	----------------------------	----------------------------	------------------------------	------------------------------	-------------------------------------	---------------------------------	------------------------------------	-------------------------------------	--------------------------------	--



Book a test drive



Find your G-Class



Find a Showroom

More is impossible

In off-road terrain the G-Class remains an unrivalled legend. It masters the key off-road disciplines effortlessly and with impressive results, e.g. gradeability, ground clearance, wading depth, angle of approach/departure and lateral slopes.



Front axle

It is executed as a double-wishbone axle with independent suspension and spring strut and ensures the necessary traction in even the most difficult off-road terrain. The new independent suspension enables more precise wheel location, thus in turn enabling better control of the G-Class.



Rear axle

Extremely robust rigid axle with high degree of axial twist supports the chassis and the body. The rigid axle is connected to the ladder frame by means of two lower and two upper trailing arms as well as a panhard rod, which prevents sideways movements in the suspension in terms of between the vehicle body and rigid rear axle, and ensures the necessary traction even in the most difficult terrain and based on the road surface.



Body

The ladder frame has formed the basis for the G-Class since the very beginning. The ladder frame consists of sheet steel of up to 3.4 mm in thickness with closed side members and cross members. This design is considerably more robust and better suited to off-road use than a self-supporting body.

Off-road performance

- Angle of approach/departure: 30.9°/29.9°
- Breakover angle: 25.7°
- Climbing ability: up to 100%
- Ground clearance: 24.1cm
- Maximum fording depth: 70 cm
- Side slope angle: up to 70%

Design	Technology	Model line	Model prices	Mercedes-AMG	Mercedes-AMG prices	Personalisation	Standard equipment	Genuine accessories	Technical data	Additional information
--------	------------	------------	--------------	--------------	---------------------	-----------------	--------------------	---------------------	----------------	------------------------

Inside, luxury meets adventure

The G-Class combines timeless design with cutting-edge technology to create an atmosphere that is as relaxing as it is revolutionary.



Smartphone integration²

Smartphone integration² merges the mobile phone with the infotainment system via Apple CarPlay[®] and Android Auto[™]. This gives you convenient access to the most important applications on your smartphone. You can also use apps from third-party service providers such as Spotify quickly and easily.



THERMOTRONIC automatic climate control

The THERMOTRONIC automatic climate control system with three climate zones and three climate styles provide an individual feel-good atmosphere on board. The driver and front passenger are able to set the temperature, air distribution and climate style to suit their personal needs. The third climate zone is in the rear – with separately adjustable temperature and airflow.



COMAND Online¹

Get to your destination faster and in more relaxed style with COMAND Online, the navigation system which is perfectly integrated into the cockpit. Thanks to Live Traffic Information¹ and Car-to-X Communication, you can avoid traffic jams and be made aware of possible sources of danger even earlier, for example.

¹The connection of the communication module to the mobile phone network including the emergency call system depends on the respective network coverage and availability of network providers

²Compatible mobile phone required.

Design	Technology	Model line	Model prices	Mercedes-AMG	Mercedes-AMG prices	Personalisation	Standard equipment	Genuine accessories	Technical data	Additional information
--------	------------	------------	--------------	--------------	---------------------	-----------------	--------------------	---------------------	----------------	------------------------

[Book a test drive](#)[Find your G-Class](#)[Find a Showroom](#)

AMG Line Premium Plus



Expressive and strong.

The AMG Line Premium Plus convinces with its expressive styling inside and out, thanks to the 20" AMG alloy wheels, MULTIBEAM LED headlamps and the radiator grille with chrome trim elements. Inside you're greeted by EXCLUSIVE Line interior with seats upholstered in AMG Line Nappa leather.

AMG Line Premium Plus

OTR from £131,335¹

¹The recommended on-the-road price includes the Road Fund Licence applicable to the standard model plus delivery charge (£730.00 incl. VAT), new vehicle registration fee (£55.00), fuel (£50.00 incl. VAT), and number plates (£25.00 incl. VAT). VAT is calculated at the standard rate of 20%. Some of the model features, optional extras and colours shown may not be available, or may only be available in a different specification, or at a different price

Design	Technology	Model line	Model prices	Mercedes-AMG	Mercedes-AMG prices	Personalisation	Standard equipment	Genuine accessories	Technical data	Additional information
--------	------------	------------	--------------	--------------	---------------------	-----------------	--------------------	---------------------	----------------	------------------------

AMG Line Premium Plus Standard equipment highlights



Option shown: MANUFAKTUR sea blue metallic (code 026)



Option shown: MANUFAKTUR sea blue metallic (code 026)

Exterior

20" AMG alloy wheels – 5-twin-spoke design, painted high-gloss black with a high-sheen finish (code R16)

Brake calipers with 'Mercedes-Benz' lettering

Exterior protective strips in brushed aluminium look

Heated windscreen

MULTIBEAM LED

Privacy glass

Radiator grille with chrome trim elements

Side running boards

Sliding sunroof

Spare wheel ring in stainless steel

Summer tyres

Suspension with adaptive damping adjustment

Trailer coupling with ESP® trailer stabilisation

Underguard in silver





Communications, Safety and Assistance Systems

- _____
- Burmester® surround sound system
- _____
- COMAND Online system¹ with 12.3-inch media display
- _____
- DAB digital radio tuner
- _____
- Driving Assistance package² consisting of Blind Spot Assist and Distance Assist DISTRONIC
- _____
- Parking package with 360° camera
- _____
- Pre-installation for Rear Seat Entertainment System





Burmester® surround sound system

Interior

- | | |
|-------------------------------|------------------------------------|
| _____ | _____ |
| Ambient lighting – 64 colours | Side airbags in the rear |
| _____ | _____ |
| DINAMICA roof liner in black | Upper part of dashboard in leather |
| _____ | _____ |
| EXCLUSIVE Line interior | Widescreen cockpit |
| _____ | _____ |
| Ionisation of interior air | |

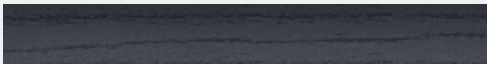
Trim and Upholstery

- | | |
|--|--|
| _____ | _____ |
| Trim – MANUFAKTUR black flamed open-pore ash wood | Upholstery – AMG Line Nappa leather, black |
|  |  |

¹The connection of the communication module to the mobile phone network including the emergency call system depends on the respective network coverage and availability of network providers as described therein

²Our driver assistance and safety systems are aids and do not relieve you of your responsibility as the driver. Please take note of the information in the Owner's Manual and the system limits which are described therein

Design	Technology	Model line	Model prices	Mercedes-AMG	Mercedes-AMG prices	Personalisation	Standard equipment	Genuine accessories	Technical data	Additional information
--------	------------	------------	--------------	--------------	---------------------	-----------------	--------------------	---------------------	----------------	------------------------

[Book a test drive](#)[Find your G-Class](#)[Find a Showroom](#)

Model prices

Model line	Engine	Transmission	CO ₂ WLTP ^{1,*}	Basic RRP excl. VAT (£)	Total RRP incl. VAT (£)	Road Fund Licence (£) ² WLTP	Rec. OTR price (£) ³ WLTP	P11D value (£)	BiK tax rate 2023/24 (%) ²
AMG Line Premium Plus									
G400 d	Diesel – 2,925 cc, 6-cylinder, 330 hp/243 kW	9G-TRONIC automatic	289	106,558.33	127,870.00	2,605.00	131,335.00	128,675.00	37

¹The indicated values were determined according to the prescribed measurement method - Worldwide Harmonised Light Vehicle Test Procedure (WLTP). Figures shown may include options which are not available in the UK. ²Figures shown are for comparability purposes; only compare with other cars tested to the same technical procedures. Figures may not reflect real life driving results, which will depend upon a number of factors including factory-fitted options, accessories fitted (post registration), variations in weather, driving styles and vehicle load. Further information about the test used to establish fuel consumption and CO₂ figures can be found at <http://www.mercedes-benz.co.uk/WLTP> ³A different first year rate of Vehicle Excise Duty (Road Fund Licence) applies for new cars. Please refer to page 64 for the relevant rate for the second and subsequent years ⁴The recommended on-the-road price includes the Road Fund Licence applicable to the standard model plus delivery charge (£730.00 incl. VAT), new vehicle registration fee (£55.00), fuel (£50.00 incl. VAT), and number plates (£25.00 incl. VAT). VAT is calculated at the standard rate of 20%. Some of the model features, optional extras and colours shown may not be available, or may only be available in a different specification, or at a different price



Book a test drive



Find your G-Class



Find a Showroom



AMG



G-Class

Mercedes-AMG

Design	Technology	Model line	Model prices	Mercedes-AMG	Mercedes-AMG prices	Personalisation	Standard equipment	Genuine accessories	Technical data	Additional information
--------	------------	------------	--------------	--------------	---------------------	-----------------	--------------------	---------------------	----------------	------------------------



Book a test drive



Find your G-Class



Find a Showroom

Mercedes-AMG G-Class Model lines overview



Mercedes-AMG G 63 »



Mercedes-AMG G 63 Carbon Edition »



Mercedes-AMG G 63 Magno Edition »

Design	Technology	Model line	Model prices	Mercedes-AMG	Mercedes-AMG prices	Personalisation	Standard equipment	Genuine accessories	Technical data	Additional information
--------	------------	------------	--------------	--------------	---------------------	-----------------	--------------------	---------------------	----------------	------------------------



Mercedes-AMG G 63 Standard equipment highlights



Option shown: periclae green metallic (code 300)



Option shown: periclae green metallic (code 300)

Engine, Transmission and Suspension

AMG RIDE CONTROL suspension with DYNAMIC SELECT

AMG SPEEDSHIFT TCT 9G

Exterior

22" AMG forged wheels – cross-spoke design, painted matt black with a high-sheen rim flange (code RG4)

AMG performance sports exhaust system with chrome-trimmed twin tailpipes

AMG red brake callipers

AMG-specific radiator grille

Exterior protective strip with trim insert in black with AMG logo, silver-coloured

Electric sunroof – sliding, with one-touch opening

Heated windscreen

Metallic paint

MULTIBEAM LED headlamps with Adaptive Highbeam Assist Plus

Privacy glass

Side running boards

Spare wheel ring in stainless steel

Summer tyres

Trailer coupling ESP® trailer stabilisation

Underguard in silver



OTR from £174,665¹

¹The recommended on-the-road price includes the Road Fund Licence applicable to the standard model plus delivery charge (£730.00 incl. VAT), new vehicle registration fee (£55.00), fuel (£50.00 incl. VAT), and number plates (£25.00 incl. VAT). VAT is calculated at the standard rate of 20%. Some of the model features, optional extras and colours shown may not be available, or may only be available in a different specification, or at a different price

Design	Technology	Model line	Model prices	Mercedes-AMG	Mercedes-AMG prices	Personalisation	Standard equipment	Genuine accessories	Technical data	Additional information
--------	------------	------------	--------------	--------------	---------------------	-----------------	--------------------	---------------------	----------------	------------------------

No-cost option shown: Exclusive Nappa leather platinum white/black (code 953A + P76)



Interior

Ambient lighting - choice of 64 colour settings

AMG floor mats with 'AMG' lettering

AMG-specific IWC-design analogue clock

AMG sports seats in AMG Nappa leather

DINAMICA roof liner in black

Heated AMG Performance steering wheel in Nappa leather

Illuminated AMG door sill panels with 'AMG' lettering at front and rear

Ionisation of interior air

Upper part of dashboard in leather

Communications, Safety and Assistance Systems

AMG dual bonded widescreen cockpit displays (12.3-inch)

Burmester® surround sound system

COMAND Online system¹ with 12.3-inch media display

DAB digital radio tuner

Driving Assistance package²

Parking package with 360° camera

Smartphone integration³ including Apple CarPlay® and Android Auto™



No-cost option shown: Exclusive Nappa leather platinum white/black (code 953A + P76)

Trim and Upholstery

Trim - MANUFAKTUR black piano lacquer

Upholstery - AMG Nappa leather, black

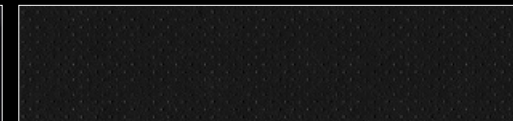
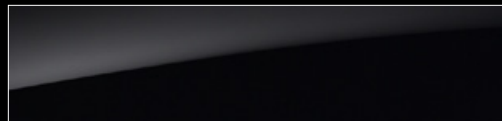

¹The connection of the communication module to the mobile phone network including the emergency call system depends on the respective network coverage and availability of network providers as described therein

³Compatible mobile phone required

²Our driver assistance and safety systems are aids and do not relieve you of your responsibility as the driver. Please take note of the information in the Owner's Manual and the system limits which

Design	Technology	Model line	Model prices	Mercedes-AMG	Mercedes-AMG prices	Personalisation	Standard equipment	Genuine accessories	Technical data	Additional information
--------	------------	------------	--------------	--------------	---------------------	-----------------	--------------------	---------------------	----------------	------------------------

Mercedes-AMG G 63 Carbon Edition Standard equipment highlights



Option shown: opalite white bright (code 885)



Option shown: opalite white bright (code 885)



In addition to/replacement of Mercedes-AMG G 63:

Exterior

22" AMG forged wheels - cross-spoke design, painted matt black with a high-sheen rim flange (code RG4)

AMG Night package

Spare wheel ring in obsidian black

Summer tyres

Underguard in obsidian black

OTR from £181,565¹

¹The recommended on-the-road price includes the Road Fund Licence applicable to the standard model plus delivery charge (£730.00 incl. VAT), new vehicle registration fee (£55.00), fuel (£50.00 incl. VAT), and number plates (£25.00 incl. VAT). VAT is calculated at the standard rate of 20%. Some of the model features, optional extras and colours shown may not be available, or may only be available in a different specification, or at a different price

Design	Technology	Model line	Model prices	Mercedes-AMG	Mercedes-AMG prices	Personalisation	Standard equipment	Genuine accessories	Technical data	Additional information
--------	------------	------------	--------------	--------------	---------------------	-----------------	--------------------	---------------------	----------------	------------------------

AMG Performance steering wheel in carbon-fibre design/DINAMICA microfibre



Interior

AMG carbon-fibre trim elements

Heated AMG Performance steering wheel in carbon-fibre design/DINAMICA microfibre

Trim and Upholstery

Trim - AMG carbon fibre

Upholstery - AMG Nappa leather, black

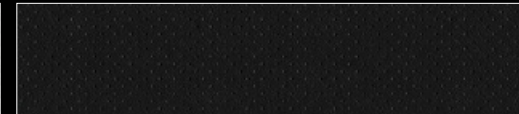

Design	Technology	Model line	Model prices	Mercedes-AMG	Mercedes-AMG prices	Personalisation	Standard equipment	Genuine accessories	Technical data	Additional information
--------	------------	------------	--------------	--------------	---------------------	-----------------	--------------------	---------------------	----------------	------------------------

Mercedes-AMG G 63 Magno Edition Standard equipment highlights



In addition to/replacement of Mercedes-AMG G 63 Carbon Edition:

Exterior

22" AMG forged wheels – cross-spoke design, painted matt black with a high-sheen rim flange (code RG4)

AMG flared wheel arches and bumpers in night black magno

AMG Night package II, including typography & Mercedes star at front and rear, in high-gloss black

AMG Night package magno

Spare wheel ring painted night black magno

Summer tyres

Underguard in night black magno



OTR from **£193,395¹**

¹The recommended on-the-road price includes the Road Fund Licence applicable to the standard model plus delivery charge (£730.00 incl. VAT), new vehicle registration fee (£55.00), fuel (£50.00 incl. VAT), and number plates (£25.00 incl. VAT). VAT is calculated at the standard rate of 20%. Some of the model features, optional extras and colours shown may not be available, or may only be available in a different specification, or at a different price

Design	Technology	Model line	Model prices	Mercedes-AMG	Mercedes-AMG prices	Personalisation	Standard equipment	Genuine accessories	Technical data	Additional information
--------	------------	------------	--------------	--------------	---------------------	-----------------	--------------------	---------------------	----------------	------------------------



No-cost option shown: MANUFAKTUR titanium grey pearl/black (code 958A + P77)



Trim and Upholstery

Trim – AMG carbon fibre

Upholstery – AMG Exclusive Nappa leather, black

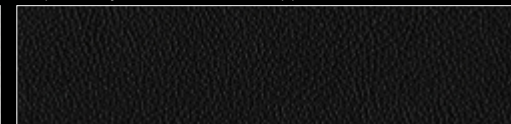
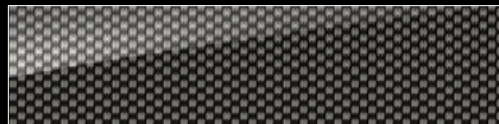

Interior

Active Multicontour Seat package Plus

SUPERIOR Line interior

Dashboard in nappa leather

Design	Technology	Model line	Model prices	Mercedes-AMG	Mercedes-AMG prices	Personalisation	Standard equipment	Genuine accessories	Technical data	Additional information
--------	------------	------------	--------------	--------------	---------------------	-----------------	--------------------	---------------------	----------------	------------------------



Book a test drive



Find your G-Class



Find a Showroom

Become the AMG expert

Unleash a new level of performance.



Step into the world of performance and experience the AMG brand at Mercedes-Benz World – from the powerful sound of the engines to the smell of the leather to the unmistakable design of our vehicles.

Mercedes-Benz World invites all Mercedes-AMG customers to a complimentary adrenaline-packed driving experience. Feel the sensational AMG driving performance, develop your driving skills and even try your hand at power-sliding on the Wet Skid Circle. With expert one-to-one guidance from a Driving Specialist in the passenger seat, experience every inch of our Handling Circuits, Dynamic Straight and low friction surfaces.

[Click here for more information](#)



TERMS AND CONDITIONS

The following customers only are eligible: The first purchaser/registered keeper of a newly registered Mercedes-AMG. The complimentary training must be booked and taken within 12 months of email receipt. The training is available Monday - Friday only (excluding bank holidays) and subject to availability. Upgrades are available for an additional cost, details upon request. Transferable to individuals who reside at the same postal address only. Mercedes-Benz UK Limited reserves the right to amend or withdraw this training experience. Attendees must hold a full UK driving licence. Attendees will be required to sign the Mercedes-Benz World Driving Risk Acknowledgement prior to undertaking the training experience.

The training experience is also subject to the Mercedes-Benz World Terms and Conditions, as applicable. Retailer demonstrator vehicles are not eligible.

Design	Technology	Model line	Model prices	Mercedes-AMG	Mercedes-AMG prices	Personalisation	Standard equipment	Genuine accessories	Technical data	Additional information
--------	------------	------------	--------------	--------------	---------------------	-----------------	--------------------	---------------------	----------------	------------------------

[Book a test drive](#)[Find your G-Class](#)[Find a Showroom](#)

Mercedes-AMG prices



Model line	Engine	Transmission	CO ₂ WLTP ^{1,*}	Basic RRP excl. VAT (£)	Total RRP incl. VAT (£)	Road Fund Licence (£) ² WLTP	Rec. OTR price (£) ³ WLTP	P11D value (£)	BiK tax rate 2023/24 (%) ²
Mercedes-AMG									
Mercedes-AMG G 63 4MATIC	Petrol – 3,982cc, 8-cylinder, 585 hp/430 kW	AMG SPEEDSHIFT PLUS 9G-TRONIC	369	142,666.67	171,200.00	2,605.00	174,665.00	172,005.00	37
Mercedes-AMG Carbon Edition									
Mercedes-AMG G 63 4MATIC	Petrol – 3,982cc, 8-cylinder, 585 hp/430 kW	AMG SPEEDSHIFT PLUS 9G-TRONIC	369	148,416.67	178,100.00	2,605.00	181,565.00	178,905.00	37
Mercedes-AMG Magno Edition									
Mercedes-AMG G 63 4MATIC	Petrol – 3,982cc, 8-cylinder, 585 hp/430 kW	AMG SPEEDSHIFT PLUS 9G-TRONIC	369	158,275.00	189,930.00	2,605.00	193,395.00	190,735.00	37

¹The indicated values were determined according to the prescribed measurement method - Worldwide Harmonised Light Vehicle Test Procedure (WLTP). Figures shown may include options which are not available in the UK. ²Figures shown are for comparability purposes; only compare with other cars tested to the same technical procedures. Figures may not reflect real life driving results, which will depend upon a number of factors including factory-fitted options, accessories fitted (post registration), variations in weather, driving styles and vehicle load. Further information about the test used to establish fuel consumption and CO₂ figures can be found at <http://www.mercedes-benz.co.uk/WLTP> ³A different first year rate of Vehicle Excise Duty (Road Fund Licence) applies for new cars. Please refer to page 64 for the relevant rate for the second and subsequent years ⁴The recommended on-the-road price includes the Road Fund Licence applicable to the standard model plus delivery charge (£730.00 incl. VAT), new vehicle registration fee (£55.00), fuel (£50.00 incl. VAT), and number plates (£25.00 incl. VAT). VAT is calculated at the standard rate of 20%. Some of the model features, optional extras and colours shown may not be available, or may only be available in a different specification, or at a different price

Design	Technology	Model line	Model prices	Mercedes-AMG	Mercedes-AMG prices	Personalisation	Standard equipment	Genuine accessories	Technical data	Additional information
--------	------------	------------	--------------	--------------	---------------------	-----------------	--------------------	---------------------	----------------	------------------------

Personalisation Overview

Trims »



Wheels »



Paints »



Upholstery »

Packages »



Trim AMG Line Premium Plus

Standard No-cost option



VA1 MANUFAKTUR black flamed open-pore ash wood

AMG Line Premium Plus



VA2 Open-pore natural walnut wood

AMG Line Premium Plus



ZG2 MANUFAKTUR black piano lacquer

AMG Line Premium Plus



Trim Mercedes-AMG

● Standard □ No-cost option — Not available



ZG2 MANUFAKTUR black piano lacquer

Mercedes-AMG G 63	●
Mercedes-AMG G 63 Carbon Edition	—
Mercedes-AMG G 63 Magno Edition	—



ZG6 AMG carbon fibre

Mercedes-AMG G 63	—
Mercedes-AMG G 63 Carbon Edition	●
Mercedes-AMG G 63 Magno Edition	●



VA1 MANUFAKTUR black flamed open-pore ash wood

Mercedes-AMG G 63	□
Mercedes-AMG G 63 Carbon Edition	—
Mercedes-AMG G 63 Magno Edition	—



VA2 Open-pore natural walnut wood

Mercedes-AMG G 63	□
Mercedes-AMG G 63 Carbon Edition	—
Mercedes-AMG G 63 Magno Edition	—



Book a test drive



Find your G-Class



Find a Showroom

Upholstery AMG Line Premium Plus (nappa leather¹ – no-cost option)



501A*+P76 black



545A+P76 nut brown/black



537A+P76 classic red/black



575A+P76 macchiato beige/black

*Standard. Available with MANUFAKTUR seat belts in red ¹100% of seat upholstery is pure leather

Design	Technology	Model line	Model prices	Mercedes-AMG	Mercedes-AMG prices	Personalisation	Standard equipment	Genuine accessories	Technical data	Additional information
--------	------------	------------	--------------	--------------	---------------------	-----------------	--------------------	---------------------	----------------	------------------------

Upholstery

AMG Line Premium Plus (MANUFAKTUR nappa leather¹ – no-cost option)



922A+P76 yacht blue/black



924A+P76 espresso brown/black



928A+P76 titanium grey pearl/black



923A+P76 platinum white/black



927A+P76 bengal red/black



934A+P76 saddle brown/black

¹100% of seat upholstery is pure leather

Design	Technology	Model line	Model prices	Mercedes-AMG	Mercedes-AMG prices	Personalisation	Standard equipment	Genuine accessories	Technical data	Additional information
------------------------	----------------------------	----------------------------	------------------------------	------------------------------	-------------------------------------	---------------------------------	------------------------------------	-------------------------------------	--------------------------------	--



Book a test drive



Find your G-Class



Find a Showroom

Upholstery AMG Line Premium Plus (MANUFAKTUR nappa leather¹ – no-cost option)



952A+P76 two-tone yacht blue/black



954A+P76 two-tone espresso brown/black



958A+P76 two-tone titanium grey/black



953A+P76 two-tone platinum white/black



957A+P76 two-tone bengal red/black



964A+P76 two-tone saddle brown/black

¹100% of seat upholstery is pure leather

Design	Technology	Model line	Model prices	Mercedes-AMG	Mercedes-AMG prices	Personalisation	Standard equipment	Genuine accessories	Technical data	Additional information
--------	------------	------------	--------------	--------------	---------------------	-----------------	--------------------	---------------------	----------------	------------------------



Book a test drive



Find your G-Class



Find a Showroom

Upholstery AMG Line Premium Plus (MANUFAKTUR nappa leather¹ with contrasting topstitching – no-cost option)



902A+P76 black with yacht blue topstitching



904A+P76 black with bronze topstitching



907A+P76 black with red topstitching



903A+P76 black with white topstitching



906A+P76 black with lime green topstitching



909A+P76 black with gold topstitching

¹100% of seat upholstery is pure leather

Design	Technology	Model line	Model prices	Mercedes-AMG	Mercedes-AMG prices	Personalisation	Standard equipment	Genuine accessories	Technical data	Additional information
--------	------------	------------	--------------	--------------	---------------------	-----------------	--------------------	---------------------	----------------	------------------------



Book a test drive



Find your G-Class



Find a Showroom

Upholstery Mercedes-AMG (AMG nappa leather¹ – no-cost option)



501A+P76* black



545A+P76* truffle brown/black



537A+P76* classic red/black



575A+P76* macchiato beige/black

*Standard on Mercedes-AMG G63 and Mercedes-AMG G63 Carbon Edition. Not available on Mercedes-AMG G63 Magno Edition. Available with MANUFAKTUR seat belts in red

¹100% of upholstery is pure leather

Design	Technology	Model line	Model prices	Mercedes-AMG	Mercedes-AMG prices	Personalisation	Standard equipment	Genuine accessories	Technical data	Additional information
--------	------------	------------	--------------	--------------	---------------------	-----------------	--------------------	---------------------	----------------	------------------------



Book a test drive



Find your G-Class



Find a Showroom

Upholstery Mercedes-AMG (AMG MANUFAKTUR nappa leather¹ – no-cost option)



912A+P76* two-tone black with accent band in yacht blue



917A+P76* two-tone black with accent band in bengal red



953A+P76* two-tone platinum white/black



957A+P76* two-tone bengal red/black



964A+P76* two-tone saddle brown/black



916A+P76* two-tone black with accent band in lime green



952A+P76* two-tone yacht blue/black



954A+P76* two-tone espresso brown/black



958A+P76* two-tone titanium grey/black

*Not available on Mercedes-AMG G63 Magno Edition ¹100% of seat upholstery is pure leather

Design	Technology	Model line	Model prices	Mercedes-AMG	Mercedes-AMG prices	Personalisation	Standard equipment	Genuine accessories	Technical data	Additional information
--------	------------	------------	--------------	--------------	---------------------	-----------------	--------------------	---------------------	----------------	------------------------



Book a test drive



Find your G-Class



Find a Showroom

Upholstery Mercedes-AMG (AMG MANUFAKTUR nappa leather¹ – no-cost option)



922A+P76* yacht blue/black



924A+P76* espresso brown/black



928A+P76* titanium grey pearl/black



923A+P76* platinum white/black



927A+P76* bengal red/black



934A+P76* saddle brown/black

*Not available on Mercedes-AMG G 63 Magno Edition ¹100% of seat upholstery is pure leather

Design	Technology	Model line	Model prices	Mercedes-AMG	Mercedes-AMG prices	Personalisation	Standard equipment	Genuine accessories	Technical data	Additional information
--------	------------	------------	--------------	--------------	---------------------	-----------------	--------------------	---------------------	----------------	------------------------



Book a test drive



Find your G-Class



Find a Showroom

Upholstery Mercedes-AMG (AMG MANUFAKTUR nappa leather¹ with contrasting topstitching – no-cost option)



902A+P76* black with yacht blue topstitching



904A+P76* black with bronze topstitching



907A+P76* black with red topstitching



903A+P76* black with white topstitching



906A+P76* black with lime green topstitching



909A+P76* black with gold topstitching

*Not available on Mercedes-AMG G63 Magno Edition ¹100% of seat upholstery is pure leather

Design	Technology	Model line	Model prices	Mercedes-AMG	Mercedes-AMG prices	Personalisation	Standard equipment	Genuine accessories	Technical data	Additional information
--------	------------	------------	--------------	--------------	---------------------	-----------------	--------------------	---------------------	----------------	------------------------



Book a test drive



Find your G-Class



Find a Showroom

Wheels AMG Line Premium Plus

- Standard
- No-cost option



R16 20" AMG alloy wheels - 5-twin-spoke design, painted high-gloss black with a high-shine finish, 275/50 R20 tyres

AMG Line Premium Plus



R17 20" AMG alloy wheels - 5-twin-spoke design, painted himalayas grey with a high-shine finish, 275/50 R20 tyres

AMG Line Premium Plus



Design	Technology	Model line	Model prices	Mercedes-AMG	Mercedes-AMG prices	Personalisation	Standard equipment	Genuine accessories	Technical data	Additional information
--------	------------	------------	--------------	--------------	---------------------	-----------------	--------------------	---------------------	----------------	------------------------



Book a test drive



Find your G-Class



Find a Showroom

Wheels Mercedes-AMG

- Standard
- No-cost option



RG4 22" AMG forged wheels - cross-spoke design, painted matt black with a high-sheen rim flange, 295/40 R22 tyres

Mercedes-AMG G63

Mercedes-AMG G63 Carbon Edition

Mercedes-AMG G63 Magno Edition



RG5 22" AMG forged wheels - cross-spoke design, painted titanium grey with a high-sheen finish, 295/40 R22 tyres

Mercedes-AMG G63

Mercedes-AMG G63 Carbon Edition

Mercedes-AMG G63 Magno Edition

Design	Technology	Model line	Model prices	Mercedes-AMG	Mercedes-AMG prices	Personalisation	Standard equipment	Genuine accessories	Technical data	Additional information
--------	------------	------------	--------------	--------------	---------------------	-----------------	--------------------	---------------------	----------------	------------------------

[Book a test drive](#)[Find your G-Class](#)[Find a Showroom](#)

Colour options Non-metallic and metallic paints

● Standard □ No-cost option – Not available



149 polar white non-metallic	
AMG Line Premium Plus	●
Mercedes-AMG G 63	□
Mercedes-AMG G 63 Carbon Edition	□
Mercedes-AMG G 63 Magno Edition	–



775 iridium silver metallic	
AMG Line Premium Plus	□
Mercedes-AMG G 63	●
Mercedes-AMG G 63 Carbon Edition	●
Mercedes-AMG G 63 Magno Edition	–



896 brilliant blue metallic	
AMG Line Premium Plus	□
Mercedes-AMG G 63	□
Mercedes-AMG G 63 Carbon Edition	□
Mercedes-AMG G 63 Magno Edition	–



992 selenite grey metallic	
AMG Line Premium Plus	□
Mercedes-AMG G 63	□
Mercedes-AMG G 63 Carbon Edition	□
Mercedes-AMG G 63 Magno Edition	–



197 obsidian black metallic	
AMG Line Premium Plus	□
Mercedes-AMG G 63	□
Mercedes-AMG G 63 Carbon Edition	□
Mercedes-AMG G 63 Magno Edition	–



890 cavansite blue metallic	
AMG Line Premium Plus	□
Mercedes-AMG G 63	□
Mercedes-AMG G 63 Carbon Edition	□
Mercedes-AMG G 63 Magno Edition	–



989 emerald green metallic	
AMG Line Premium Plus	□
Mercedes-AMG G 63	□
Mercedes-AMG G 63 Carbon Edition	□
Mercedes-AMG G 63 Magno Edition	–

Please note that, owing to limitations of on-screen representation, paint colours may differ from those shown

[Book a test drive](#)[Find your G-Class](#)[Find a Showroom](#)

Colour options MANUFAKTUR paints

○ Optional – Not available



026 sea blue metallic

AMG Line Premium Plus	○
Mercedes-AMG G63	○
Mercedes-AMG G63 Carbon Edition	○
Mercedes-AMG G63 Magno Edition	–
Total RRP incl. VAT	£4,000



041 graphite metallic

AMG Line Premium Plus	○
Mercedes-AMG G63	○
Mercedes-AMG G63 Carbon Edition	○
Mercedes-AMG G63 Magno Edition	–
Total RRP incl. VAT	£4,000



162 south seas blue metallic

AMG Line Premium Plus	○
Mercedes-AMG G63	○
Mercedes-AMG G63 Carbon Edition	○
Mercedes-AMG G63 Magno Edition	–
Total RRP incl. VAT	£4,000



300 periclas green metallic

AMG Line Premium Plus	○
Mercedes-AMG G63	○
Mercedes-AMG G63 Carbon Edition	○
Mercedes-AMG G63 Magno Edition	–
Total RRP incl. VAT	£4,000



660 rubellite red metallic

AMG Line Premium Plus	○
Mercedes-AMG G63	○
Mercedes-AMG G63 Carbon Edition	○
Mercedes-AMG G63 Magno Edition	–
Total RRP incl. VAT	£4,000



032 mystic blue bright

AMG Line Premium Plus	○
Mercedes-AMG G63	○
Mercedes-AMG G63 Carbon Edition	○
Mercedes-AMG G63 Magno Edition	–
Total RRP incl. VAT	£4,000



124 classic grey solid

AMG Line Premium Plus	○
Mercedes-AMG G63	○
Mercedes-AMG G63 Carbon Edition	○
Mercedes-AMG G63 Magno Edition	–
Total RRP incl. VAT	£4,000



255 olive metallic

AMG Line Premium Plus	○
Mercedes-AMG G63	○
Mercedes-AMG G63 Carbon Edition	○
Mercedes-AMG G63 Magno Edition	–
Total RRP incl. VAT	£4,000



464 desert sand non-metallic

AMG Line Premium Plus	○
Mercedes-AMG G63	○
Mercedes-AMG G63 Carbon Edition	○
Mercedes-AMG G63 Magno Edition	–
Total RRP incl. VAT	£4,000



693 travertine beige metallic

AMG Line Premium Plus	○
Mercedes-AMG G63	○
Mercedes-AMG G63 Carbon Edition	○
Mercedes-AMG G63 Magno Edition	–
Total RRP incl. VAT	£4,000

Please note that, owing to limitations of on-screen representation, paint colours may differ from those shown

Design	Technology	Model line	Model prices	Mercedes-AMG	Mercedes-AMG prices	Personalisation	Standard equipment	Genuine accessories	Technical data	Additional information
--------	------------	------------	--------------	--------------	---------------------	-----------------	--------------------	---------------------	----------------	------------------------

[Book a test drive](#)[Find your G-Class](#)[Find a Showroom](#)

Colour options MANUFAKTUR paints

○ Optional – Not available



825 deep green non-metallic

AMG Line Premium Plus	○
Mercedes-AMG G63	○
Mercedes-AMG G63 Carbon Edition	○
Mercedes-AMG G63 Magno Edition	–
Total RRP incl. VAT	£4,000



904 dark blue non-metallic

AMG Line Premium Plus	○
Mercedes-AMG G63	○
Mercedes-AMG G63 Carbon Edition	○
Mercedes-AMG G63 Magno Edition	–
Total RRP incl. VAT	£4,000



934 vintage blue non-metallic

AMG Line Premium Plus	○
Mercedes-AMG G63	○
Mercedes-AMG G63 Carbon Edition	○
Mercedes-AMG G63 Magno Edition	–
Total RRP incl. VAT	£4,000



996 hyacinth red metallic

AMG Line Premium Plus	○
Mercedes-AMG G63	○
Mercedes-AMG G63 Carbon Edition	○
Mercedes-AMG G63 Magno Edition	–
Total RRP incl. VAT	£4,000



885 opalite white bright

AMG Line Premium Plus	○
Mercedes-AMG G63	○
Mercedes-AMG G63 Carbon Edition	○
Mercedes-AMG G63 Magno Edition	–
Total RRP incl. VAT	£4,000



914 sun yellow non-metallic

AMG Line Premium Plus	○
Mercedes-AMG G63	○
Mercedes-AMG G63 Carbon Edition	○
Mercedes-AMG G63 Magno Edition	–
Total RRP incl. VAT	£4,000



963 indium grey metallic

AMG Line Premium Plus	○
Mercedes-AMG G63	○
Mercedes-AMG G63 Carbon Edition	○
Mercedes-AMG G63 Magno Edition	–
Total RRP incl. VAT	£4,000

Please note that, owing to limitations of on-screen representation, paint colours may differ from those shown

Design	Technology	Model line	Model prices	Mercedes-AMG	Mercedes-AMG prices	Personalisation	Standard equipment	Genuine accessories	Technical data	Additional information
--------	------------	------------	--------------	--------------	---------------------	-----------------	--------------------	---------------------	----------------	------------------------

[Book a test drive](#)[Find your G-Class](#)[Find a Showroom](#)

Colour options MANUFAKTUR magno¹ paints

● Standard □ No-cost option ○ Optional



051 platinum magno	
AMG Line Premium Plus	○
Mercedes-AMG G63	○
Mercedes-AMG G63 Carbon Edition	○
Mercedes-AMG G63 Magno Edition	□
Total RRP incl. VAT	£6,000



056 night black magno	
AMG Line Premium Plus	○
Mercedes-AMG G63	○
Mercedes-AMG G63 Carbon Edition	○
Mercedes-AMG G63 Magno Edition	□
Total RRP incl. VAT	£6,000



271 citrine brown magno	
AMG Line Premium Plus	○
Mercedes-AMG G63	○
Mercedes-AMG G63 Carbon Edition	○
Mercedes-AMG G63 Magno Edition	□
Total RRP incl. VAT	£6,000



659 opalite white magno	
AMG Line Premium Plus	○
Mercedes-AMG G63	○
Mercedes-AMG G63 Carbon Edition	○
Mercedes-AMG G63 Magno Edition	□
Total RRP incl. VAT	£6,000



795 manganite grey magno	
AMG Line Premium Plus	○
Mercedes-AMG G63	○
Mercedes-AMG G63 Carbon Edition	○
Mercedes-AMG G63 Magno Edition	□
Total RRP incl. VAT	£6,000



054 monza grey magno	
AMG Line Premium Plus	○
Mercedes-AMG G63	○
Mercedes-AMG G63 Carbon Edition	○
Mercedes-AMG G63 Magno Edition	□
Total RRP incl. VAT	£6,000



164 dark olive magno	
AMG Line Premium Plus	○
Mercedes-AMG G63	○
Mercedes-AMG G63 Carbon Edition	○
Mercedes-AMG G63 Magno Edition	□
Total RRP incl. VAT	£6,000



658 copper orange magno	
AMG Line Premium Plus	○
Mercedes-AMG G63	○
Mercedes-AMG G63 Carbon Edition	○
Mercedes-AMG G63 Magno Edition	□
Total RRP incl. VAT	£6,000



677 kalahari gold magno	
AMG Line Premium Plus	○
Mercedes-AMG G63	○
Mercedes-AMG G63 Carbon Edition	○
Mercedes-AMG G63 Magno Edition	□
Total RRP incl. VAT	£6,000

¹MANUFAKTUR magno matt paint finishes require extra care. Please refer to the Owner's Manual for instructions Please note that, owing to limitations of on-screen representation, paint colours may differ from those shown

Colour options MANUFAKTUR exclusive magno¹ paints

Standard
 No-cost option
 Optional



376 green hell exclusive magno

AMG Line Premium Plus	–
Mercedes-AMG G63	<input type="radio"/>
Mercedes-AMG G63 Carbon Edition	<input type="radio"/>
Mercedes-AMG G63 Magno Edition	<input type="checkbox"/>
Total RRP incl. VAT	£7,500



823 hyacinth red exclusive magno

AMG Line Premium Plus	–
Mercedes-AMG G63	–
Mercedes-AMG G63 Carbon Edition	<input type="checkbox"/>
Mercedes-AMG G63 Magno Edition	<input type="checkbox"/>
Total RRP incl. VAT	£7,500



644 brilliant blue exclusive magno

AMG Line Premium Plus	–
Mercedes-AMG G63	–
Mercedes-AMG G63 Carbon Edition	<input type="checkbox"/>
Mercedes-AMG G63 Magno Edition	<input type="checkbox"/>
Total RRP incl. VAT	£7,500

¹MANUFAKTUR magno matt paint finishes require extra care. Please refer to the Owner's Manual for instructions. Please note that, owing to limitations of on-screen representation, paint colours may differ from those shown.

[Book a test drive](#)[Find your G-Class](#)[Find a Showroom](#)

MANUFAKTUR package

The MANUFAKTUR package offers a wealth of upholstery combinations, enhancing the individualisation of the iconic G-Class.

MANUFAKTUR package (code DPM) – designed and priced as a package.

AMG Line Premium Plus, Mercedes-AMG G 63 and Mercedes-AMG G 63 Carbon Edition

Total incl. VAT £7,995

Standard on Mercedes-AMG G 63 Magno Edition

Consisting of:

Active Multicontour Seat package Plus

ENERGIZING package

SUPERIOR Line interior

Please see pages 40–47 for available upholstery colours for AMG Line Premium Plus and Mercedes-AMG G 63.



923A+P77 platinum white/black

Design	Technology	Model line	Model prices	Mercedes-AMG	Mercedes-AMG prices	Personalisation	Standard equipment	Genuine accessories	Technical data	Additional information
--------	------------	------------	--------------	--------------	---------------------	-----------------	--------------------	---------------------	----------------	------------------------



Book a test drive



Find your G-Class



Find a Showroom

MANUFAKTUR package AMG Line Premium Plus (nappa leather¹)



801A+P77 black



825A+P77 truffle brown/black



912A+P77 two-tone black with accent band in yacht blue



917A+P77 two-tone black with accent band bengal red



953A+P77 two-tone platinum white/black



805A*+P77 macchiato beige/espresso brown



827A+P77 classic red/black



916A+P77 two-tone black with accent band lime green



952A+P77 two-tone yacht blue/black



954A+P77 two-tone espresso brown/black

*Available with MANUFAKTUR seat belts in macchiato beige ¹100% of seat upholstery is pure leather

Design	Technology	Model line	Model prices	Mercedes-AMG	Mercedes-AMG prices	Personalisation	Standard equipment	Genuine accessories	Technical data	Additional information
--------	------------	------------	--------------	--------------	---------------------	-----------------	--------------------	---------------------	----------------	------------------------

MANUFAKTUR package AMG Line Premium Plus (nappa leather¹)



957A+P77 two-tone bengal red/black



964A+P77 two-tone saddle brown/black



958A+P77 two-tone titanium grey/black

¹100% of seat upholstery is pure leather

Design	Technology	Model line	Model prices	Mercedes-AMG	Mercedes-AMG prices	Personalisation	Standard equipment	Genuine accessories	Technical data	Additional information
--------	------------	------------	--------------	--------------	---------------------	-----------------	--------------------	---------------------	----------------	------------------------

MANUFAKTUR package AMG Line Premium Plus (MANUFAKTUR nappa leather!)



922A+P77 yacht blue/black



924A+P77 espresso brown/black



928A+P77 titanium grey pearl/black



923A+P77 platinum white/black



927A+P77 bengal red/black



934A+P77 saddle brown/black

!100% of seat upholstery is pure leather

Design	Technology	Model line	Model prices	Mercedes-AMG	Mercedes-AMG prices	Personalisation	Standard equipment	Genuine accessories	Technical data	Additional information
------------------------	----------------------------	----------------------------	------------------------------	------------------------------	-------------------------------------	---------------------------------	------------------------------------	-------------------------------------	--------------------------------	--



Book a test drive



Find your G-Class



Find a Showroom

MANUFAKTUR package AMG Line Premium Plus (nappa leather¹ with topstitching)



902A+P77 black with yacht blue topstitching



904A+P77 black with bronze topstitching



907A+P77 black with red topstitching



903A+P77 black with white topstitching



906A+P77 black with lime green topstitching



909A+P77 black with gold topstitching

¹100% of seat upholstery is pure leather

Design	Technology	Model line	Model prices	Mercedes-AMG	Mercedes-AMG prices	Personalisation	Standard equipment	Genuine accessories	Technical data	Additional information
--------	------------	------------	--------------	--------------	---------------------	-----------------	--------------------	---------------------	----------------	------------------------

MANUFAKTUR package Mercedes-AMG G 63 (nappa leather¹)



801A+P77 black



825A+P77 truffle brown/black



922A+P77 yacht blue/black



912A+P77 two-tone black with accent band yacht blue



917A+P77 two-tone black with accent band bengal red



805A*+P77 macchiato beige/espresso brown²



827A+P77 classic red/black



924A+P77 espresso brown/black



916A+P77 two-tone black with accent band lime green



952A+P77 two-tone yacht blue/black

*Available with MANUFAKTUR seat belts in macchiato beige ¹100% of seat upholstery is pure leather ²805A not available on Mercedes-AMG G 63 Magno Edition or Carbon Edition

Design	Technology	Model line	Model prices	Mercedes-AMG	Mercedes-AMG prices	Personalisation	Standard equipment	Genuine accessories	Technical data	Additional information
--------	------------	------------	--------------	--------------	---------------------	-----------------	--------------------	---------------------	----------------	------------------------

MANUFAKTUR package Mercedes-AMG G 63 (nappa leather¹)



953A+P77 two-tone platinum white/black



957A+P77 two-tone bengal red/black



964A+P77 two-tone saddle brown/black



954A+P77 two-tone espresso brown/black



958A+P77 two-tone titanium grey/black

¹100% of seat upholstery is pure leather

Design	Technology	Model line	Model prices	Mercedes-AMG	Mercedes-AMG prices	Personalisation	Standard equipment	Genuine accessories	Technical data	Additional information
--------	------------	------------	--------------	--------------	---------------------	-----------------	--------------------	---------------------	----------------	------------------------



Book a test drive



Find your G-Class



Find a Showroom

MANUFAKTUR package Mercedes-AMG G 63 (MANUFAKTUR nappa leather!)



923A+P77 platinum white/black



928A+P77 titanium grey pearl



927A+P77 bengal red/black



934A+P77 saddle brown/black

!100% of seat upholstery is pure leather

Design	Technology	Model line	Model prices	Mercedes-AMG	Mercedes-AMG prices	Personalisation	Standard equipment	Genuine accessories	Technical data	Additional information
--------	------------	------------	--------------	--------------	---------------------	-----------------	--------------------	---------------------	----------------	------------------------



Book a test drive



Find your G-Class



Find a Showroom

MANUFAKTUR package Mercedes-AMG G 63 (nappa leather¹ with topstitching)



902A+P77 black with yacht blue topstitching



904A+P77 black with bronze topstitching



907A+P77 black with red topstitching



903A+P77 black with white topstitching



906A+P77 black with lime green topstitching



909A+P77 black with gold topstitching

¹100% of seat upholstery is pure leather

Design	Technology	Model line	Model prices	Mercedes-AMG	Mercedes-AMG prices	Personalisation	Standard equipment	Genuine accessories	Technical data	Additional information
--------	------------	------------	--------------	--------------	---------------------	-----------------	--------------------	---------------------	----------------	------------------------

Rear Seat Entertainment package

Films, internet, video games or music: the Rear Seat Entertainment System, with a variety of interfaces for external media, ensures nobody gets bored. The two 10-inch touchscreens installed on the backrest boast brilliant picture quality. Pre-installation for the Rear Seat Entertainment system and well as a TV tuner form part of this package.

Rear Seat Entertainment package (code DRS) – designed and priced as a package.

All model lines

Total incl. VAT £3,495.00

Consisting of:

Digital TV tuner (front screen only – does not display in rear)

Internet access via browser and email client possible

Integral media player for playback of a variety of media

Two touchscreen displays with 10-inch screen diagonal for brilliant picture quality

USB 2.0, AUX and HDMI interfaces for the integration of smartphone content, laptop content or games consoles (SD memory cards via adapter)



Please note headphones are not included in this package. Any Bluetooth® headphone will, however, work with this system.

AMG Performance package

The AMG Drive's package offers an even sportier driving experience by increasing the top speed to 150mph. Also part of this package is the AMG carbon fibre engine cover which highlights the sportiness and the structural layout of the engine components – a real eye-catching feature as soon as the bonnet is opened.

AMG Performance package (code PT2) – designed and priced as a package.

Mercedes-AMG G 63 models

Total incl. VAT £2,735.00





Night package

Add the Night package to your G 400 d to create an even bolder look. Heat-insulating dark-tinted glass in combination with the exterior mirrors and the spare wheel ring painted either obsidian black or night black magno make for a striking appearance.

Night package (code P55) – designed and priced as a package, including items listed below.

AMG Line Premium Plus

Total incl. VAT £1,500.00

Selecting Magno paint will replace Night package with Night package Magno.

Consisting of:

Darkened indicators, tail lights and headlights

Exterior mirror housing painted obsidian black or night black magno (only in conjunction with magno paints)

Exterior protective strip with trim insert in black pinstripe or night black magno (only in conjunction with magno paints)

Spare wheel rim painted obsidian black or night black magno (only in conjunction with magno paints)

Trim elements bumpers painted in obsidian black or night black magno (only in conjunction with magno paints)



Magno paint shown



[Book a test drive](#)[Find your G-Class](#)[Find a Showroom](#)

AMG Night package

Add the AMG Night package to your Mercedes-AMG G 63 to create an even bolder look. Heat-insulating dark-tinted glass in combination with the exterior mirrors and the spare wheel cover painted either obsidian black or night black magno make for a striking appearance.

AMG Night package (code P56) – designed and priced as a package, including items listed below.

Mercedes-AMG G 63

Mercedes-AMG G 63 Carbon Edition and Magno Edition

Selecting Magno paint will replace AMG Night package with AMG Night package Magno.

Total incl. VAT £2,250.00
Standard

Consisting of:

AMG-specific radiator grille, dark chrome-plated

Darkened indicators, tail lights as well as headlights

Exterior mirror housing painted obsidian black or night black magno (only in conjunction with magno paints)

Exterior protective strip with black trim insert in a pinstripe look

Simulated underguard in matt black

Spare wheel cover painted obsidian black or night black magno (only in conjunction with magno paints)

Trim elements in the bumper painted obsidian black or night black magno (only in conjunction with magno paints)



Magno paint shown

[Design](#)[Technology](#)[Model line](#)[Model prices](#)[Mercedes-AMG](#)[Mercedes-AMG prices](#)[Personalisation](#)[Standard equipment](#)[Genuine accessories](#)[Technical data](#)[Additional information](#)

[Book a test drive](#)[Find your G-Class](#)[Find a Showroom](#)

Optional equipment

○ Optional – Not available



CK4 Bumpers and flared wheel arches in obsidian black metallic

AMG Line Premium Plus	–
Mercedes-AMG G 63	○
Mercedes-AMG G 63 Carbon Edition	○
Mercedes-AMG G 63 Magno Edition	–
Total RRP incl. VAT	£650.00



F85 [F86^{4,2}] MANUFATUR roof painted in obsidian black [night black magno¹]

AMG Line Premium Plus	–	–
Mercedes-AMG G 63	○	–
Mercedes-AMG G 63 Carbon Edition	○	–
Mercedes-AMG G 63 Magno Edition	–	○
Total RRP incl. VAT	£650.00	£900.00



ZI3 MANUFATUR dashboard in two-tone nappa leather^{3,4}

AMG Line Premium Plus	○
Mercedes-AMG G 63	○
Mercedes-AMG G 63 Carbon Edition	○
Mercedes-AMG G 63 Magno Edition	○
Total RRP incl. VAT	£650.00

¹Available for Magno Edition only ²Not available with night black magno (code 056) ³Only in conjunction with code DPM

⁴Only in conjunction with code 922A, 923A, 924A, 927A, 928A, 934A, 952A, 953A, 954A, 957A, 958A and 964A

[Book a test drive](#)[Find your G-Class](#)[Find a Showroom](#)

Standard equipment AMG Line Premium Plus

Transmission and Suspension

4MATIC Permanent four-wheel drive with three 100% differentials

9G-TRONIC transmission with cruise control and variable speed limiter

DYNAMIC SELECT with ECO start/stop function and four transmission modes: 'C' (Comfort), 'S' (Sport), 'I' (Individual) and 'M' (Manual)

Suspension with adaptive damping adjustment

Exterior

Adaptive Highbeam Assist Plus – the driver is free to concentrate on the traffic without constantly having to select between low and high beam

Ambient lighting with projection of brand logo

AMG bodystyling with flared wheel arches in vehicle colour

Brake calipers with 'Mercedes-Benz' lettering

Bumpers – painted in body colour, front and rear

Diesel particulate filter

Differential locks (transfer case, front and rear axle)

Door mirrors – electrically adjustable and heated Integrated indicators, front area lighting and automatically dimming driver's mirror

Electric sunroof – sliding, with one-touch opening

Exterior protective strip with trim insert in brushed aluminium

Heated windscreen

Low range gear reduction (electronically selectable while driving)

MULTIBEAM LED headlamps enable continuous main beam without dazzling other road users. Individually controlled LEDs precisely mask out other vehicles and at the same time illuminate the surroundings in light which is almost as bright as daylight

Privacy glass – dark grey-tinted glass for tailgate and rear side windows

Rain-sensing wipers

Running boards

Spare wheel front painted in body colour

Spare wheel ring in stainless steel

Summer tyres

Tail lights featuring LED technology

Trailer coupling with ESP® trailer stabilisation

Underguard in silver – reinforced underfloor panelling the full length of the vehicle

Interior

12V sockets in centre console, rear and load compartment

Ambient lighting – 64 colours

AMG floor mats with 'AMG' lettering

Automatically dimming rear-view mirror

Centre armrest between front seats with integrated stowage compartment

Cup holders – front (2) and rear (2)

[Design](#)[Technology](#)[Model line](#)[Model prices](#)[Mercedes-AMG](#)[Mercedes-AMG prices](#)[Personalisation](#)[Standard equipment](#)[Genuine accessories](#)[Technical data](#)[Additional information](#)

[Book a test drive](#)[Find your G-Class](#)[Find a Showroom](#)

Standard equipment

AMG Line Premium Plus

Interior (continued)

Dashboard – upper part of dashboard in leather

Electric windows (4)

Front seats – heated and electrically adjustable. Memory function for seats, head restraints, exterior mirrors and steering wheel

Ionisation of interior air including fine-particle activated charcoal filter system

KEYLESS-GO starting function

Luggage compartment cover

Partition net

Rear bench seat – split folding ⅓:⅓

Rear seats – heated

Seat belts, 3-point design in black

Seat belt pre-tensioners (4)

Stainless steel door sill panels, set of four, illuminated, with 'Mercedes-Benz' lettering at the front

Stowage Space package – including removable double cup holder in centre console, bottle holders in door pockets, map pockets on back of front seats, and glasses compartment in overhead control panel

THERMOTRONIC automatic climate control with three climate zones and three climate styles:

Medium, Diffuse and Focused

Widescreen cockpit with dual bonded 12.3" widescreen displays

Steering

Steering column – electrically adjustable, with automatic adjustment for entry/exit

Steering wheel – multifunction heated steering wheel in nappa leather 3-spoke design, with round bottom section, steering wheel trim and shift paddles in silver chrome and Touch Control buttons

Paint, Trim and Upholstery

Paint – metallic

Roof lining – DINAMICA roof liner in black

Trim – MANUFAKTUR black flamed open-pore ash wood

Upholstery – Nappa leather in black

Communications and In-Car Entertainment

Bluetooth® interface for hands-free telephony

COMAND Online¹ – online-capable multimedia system with display (12.3 inches), touchpad with controller, Touch Control buttons on the steering wheel and LINGUATRONIC voice control system, hard-disk navigation with satellite map display, smartphone integration, communications module for Mercedes me services, 3 years of free online map updates, Live Traffic Information¹, Mercedes me connect Standard Services¹, Mercedes-Benz apps, Mercedes-Benz emergency call system¹, Car-to-X-Communication

Communications module (LTE) for the use of Mercedes me connect services¹ – preparation for use of Mercedes me connect services with particularly rapid and dependable data transfer

DAB digital radio tuner

Smartphone integration² comprising Apple CarPlay® and Android Auto™ – see www.apple.com/uk/ios/carplay/ or www.android.com/intl/en_uk/auto for compatibility and approved apps. Certain features and apps require a 3G/4G data connection. Control of features available through voice control and controller on centre console

Surround sound system – Burmester® surround sound system

16 high-performance speakers as well as electronics and acoustic features tailored specifically to the interior make for the first-class Burmester sound

Touchpad with controller

¹The connection of the communication module to the mobile phone network including the emergency call system depends on the respective network coverage and availability of network providers

²Compatible mobile phone required

Design	Technology	Model line	Model prices	Mercedes-AMG	Mercedes-AMG prices	Personalisation	Standard equipment	Genuine accessories	Technical data	Additional information
--------	------------	------------	--------------	--------------	---------------------	-----------------	--------------------	---------------------	----------------	------------------------



Book a test drive



Find your G-Class



Find a Showroom

Standard equipment AMG Line Premium Plus

Safety and Assistance Systems

Active Blind Spot Assist¹

Active Brake Assist¹ – consisting of proximity and collision warning, situation-dependent braking assistance and also autonomous braking function for vehicles in front, crossing pedestrians and cyclists

Active Lane Keeping Assist¹

ADAPTIVE BRAKE with HOLD function, Hill-Start Assist, priming and dry braking in the wet

Airbags – driver and front passenger

Airbags – front side

Airbags – sidebags in rear

Airbags – windowbags

Anti-lock braking system (ABS) with Brake Assist (BAS)

Anti-theft alarm system with tow-away protection and interior motion sensor (Thatcham Category 1 compliant)

ATTENTION ASSIST – can detect typical symptoms of drowsiness on the basis of driver behaviour and alert the driver to increasing fatigue and inattention

Driving Assistance package¹ consisting of Blind Spot Assist and Distance Assist DISTRONIC

Electronic Stability Programme (ESP®) with Acceleration Skid Control (ASR)

Four-wheel Electronic Traction System (4ETS)

GUARD 360° vehicle protection Plus² – anti-theft protection hardware including alarm and immobilizer. Theft notification and park damage detection³, stolen vehicle locator³, 360° surroundview-camera snapshots³ and remote key immobilizer³

Headlight Assist – automatic headlamp activation

i-Size child seat attachment system for outer rear seats

Parking Assist PARKTRONIC

Parking package with 360° camera

PRE-SAFE® system – preventive occupant protection

Service indicator ASSYST

Traffic Sign Assist

Tyre pressure monitoring system

¹Our driver assistance and safety systems are aids and do not relieve you of your responsibility as the driver. Please take note of the information in the Owner's Manual and the system limits which are described therein of network providers ²Free of charge for three years from activation

³The connection of the communication module to the mobile phone network including the emergency call system depends on the respective network coverage and availability

Design	Technology	Model line	Model prices	Mercedes-AMG	Mercedes-AMG prices	Personalisation	Standard equipment	Genuine accessories	Technical data	Additional information
--------	------------	------------	--------------	--------------	---------------------	-----------------	--------------------	---------------------	----------------	------------------------

[Book a test drive](#)[Find your G-Class](#)[Find a Showroom](#)

Standard equipment Mercedes-AMG

● Standard – Not available

Transmission and Suspension

	G 63	G 63 Carbon Edition	G 63 Magno Edition
4MATIC Permanent four-wheel drive with three 100% differentials	●	●	●
AMG DYNAMIC SELECT with ECO start/stop function and 5 transmission modes 'C' (Comfort), 'S' (Sport), S+ (Sport Plus) and 'M' (Manual)	●	●	●
AMG high-performance braking system with internally ventilated and perforated brake discs measuring 400×38 mm at the front, 370×22 mm at the rear	●	●	●
AMG RIDE CONTROL suspension with three settings 'C' (Comfort), 'S' (Sport), S+ (Sport Plus) accessible via DYNAMIC SELECT	●	●	●
AMG SPEEDSHIFT 9G-TRONIC sports transmission with cruise control and variable speed limiter	●	●	●

Exterior

Adaptive Highbeam Assist Plus – the driver is free to concentrate on the traffic without constantly having to select between low and high beam	●	●	●
Ambient lighting with projection of brand logo	●	●	●
AMG bodystyling with Mercedes-AMG G 63 front aprons with cooling air intakes and flared wheel arches in vehicle colour and bumpers painted in body colour, front and rear	●	●	–
AMG bodystyling with exclusive AMG flared wheel arches and bumpers in night black magno	–	–	●
AMG brake callipers, painted red	●	●	●
AMG Night package	–	●	–
AMG Night package Magno	–	–	●
AMG Night package II – typography in high-gloss black and Mercedes-Benz star in high-gloss black front and rear	–	–	●
AMG performance exhaust system, selectable and two chrome-trimmed twin tailpipes, left and right	●	●	●
AMG-specific radiator grille with AMG logo	●	●	●

	G 63	G 63 Carbon Edition	G 63 Magno Edition
Differential locks (transfer case, front and rear axle)	●	●	●
Door mirrors – electrically adjustable and heated Integrated indicators, front area lighting and automatically dimming driver's mirror	●	●	●
Electric sunroof – sliding, with one-touch opening	●	●	●
Exterior mirror housings in black	–	●	●
Exterior protective strip with trim insert in black	●	●	●
Heated windscreen	●	●	●
Low range gear reduction (electronically selectable while driving)	●	●	●
MULTIBEAM LED headlamps enable continuous main beam without dazzling other road users. Individually controlled LEDs precisely mask out other vehicles and at the same time illuminate the surroundings in light which is almost as bright as daylight	●	●	●
Petrol particulate filter	●	●	●
Privacy glass – dark grey-tinted glass for tailgate and rear side windows	●	●	●
Rain-sensing wipers	●	●	●
Running boards	●	●	●
Spare wheel – spare wheel front in body colour	●	●	●
Spare wheel – spare wheel ring in night black magno	–	–	●
Spare wheel – spare wheel ring in obsidian black	–	●	–
Spare wheel – spare wheel ring in stainless steel	●	–	–
Summer tyres	●	●	●
Tail lights featuring LED technology	●	●	●
Trailer coupling with ESP® trailer stabilisation	●	●	●

[Book a test drive](#)[Find your G-Class](#)[Find a Showroom](#)

Standard equipment Mercedes-AMG

● Standard – Not available

Interior

	G 63	G 63 Carbon Edition	G 63 Magno Edition
12V sockets in centre console, rear and load compartment	●	●	●
Active Multicontour Seat package Plus – SUPERIOR Line interior, dashboard in nappa leather	–	–	●
Ambient lighting – 64 colours	●	●	●
AMG door sill panels in brushed stainless steel, illuminated	●	●	●
AMG floor mats with 'AMG' lettering	●	●	●
AMG instrument cluster with dual bonded 12.3" widescreen displays	●	●	●
AMG-specific IWC-design analogue clock	●	●	●
Automatically dimming rear-view mirror	●	●	●
Centre armrest between front seats with integrated stowage compartment	●	●	●
Cup holders – front (2) and rear (2)	●	●	●
Dashboard – upper part of dashboard in leather	●	●	–
Dashboard – upper part of dashboard in nappa leather	–	–	●
Electric windows (4)	●	●	●
ENERGIZING comfort control	–	–	●
Front seats – heated and electrically adjustable. Memory function for seats, head restraints, exterior mirrors and steering wheel	●	●	●
Ionisation of interior air including fine-particle activated charcoal filter system	●	●	●
KEYLESS-GO starting function	●	●	●
Luggage compartment cover	●	●	●
Partition net	●	●	●
Rear bench seat – split folding 1/3:2/3	●	●	●
Rear seats – heated	●	●	●
Seat belts, 3-point design in black	●	●	●

	G 63	G 63 Carbon Edition	G 63 Magno Edition
Seat belt pre-tensioners (4)	●	●	●
Stowage Space package – including removable double cup holder in centre console, bottle holders in door pockets, map pockets on back of front seats, and glasses compartment in overhead control panel	●	●	●
THERMOTRONIC automatic climate control with three climate zones and three climate styles: Medium, Diffuse and Focused	●	●	●

Steering

	G 63	G 63 Carbon Edition	G 63 Magno Edition
Heated AMG performance steering wheel in carbon fibre/DINAMICA microfibre 3-spoke design, with flattened bottom section, steering wheel trim in silver chrome with 'AMG' lettering and silver-coloured aluminium shift paddles, 12 o'clock marking and touch control buttons	–	●	●
Heated AMG performance steering wheel in nappa leather 3-spoke design, with flattened bottom section, steering wheel trim in silver chrome with 'AMG' lettering and silver-coloured aluminium shift paddles, 12 o'clock marking and touch control buttons	●	–	–
Steering column – electrically adjustable, with automatic adjustment for entry/exit	●	●	●

Paint, Trim and Upholstery

	G 63	G 63 Carbon Edition	G 63 Magno Edition
Paint – magno	–	–	●
Paint – metallic	●	●	–
Roof lining – DINAMICA roof liner in black	●	●	●
Trim – AMG carbon fibre	–	●	●
Trim – MANUFAKTUR black piano lacquer	●	–	–
Upholstery – AMG exclusive interior with nappa leather	●	●	–
Upholstery – AMG superior interior with Exclusive nappa leather	–	–	●

[Book a test drive](#)[Find your G-Class](#)[Find a Showroom](#)

Standard equipment Mercedes-AMG

● Standard – Not available

Communications and In-Car Entertainment

	G 63	G 63 Carbon Edition	G 63 Magno Edition
Bluetooth® interface for hands-free telephony	●	●	●
COMAND Online ¹ – online-capable multimedia system with display (12.3 inches), touchpad with controller, Touch Control buttons on the steering wheel and LINGUATRONIC voice control system, hard-disk navigation with satellite map display, smartphone integration, communications module for Mercedes me services, 3 years of free online map updates, Live Traffic Information ¹ , Mercedes me connect Standard Services ¹ , Mercedes-Benz apps, Mercedes-Benz emergency call system ¹ , Car-to-X-Communication	●	●	●
Communications module (LTE) for the use of Mercedes me connect services ¹ – preparation for use of Mercedes me connect services with particularly rapid and dependable data transfer	●	●	●
DAB digital radio tuner	●	●	●
Smartphone integration ² comprising Apple CarPlay® and Android Auto™ – see www.apple.com/uk/ios/carplay/ or www.android.com/intl/en_uk/auto for compatibility and approved apps. Certain features and apps require a 3G/4G data connection. Control of features available through voice control and controller on centre console	●	●	●
Surround sound system – Burmester® surround sound system 16 high-performance speakers as well as electronics and acoustic features tailored specifically to the interior make for the first-class Burmester sound	●	●	●
Touchpad with controller	●	●	●

Safety and Assistance Systems

Active Blind Spot Assist ³	●	●	●
Active Brake Assist ³ – consisting of proximity and collision warning, situation-dependent braking assistance and also autonomous braking function for vehicles in front, crossing pedestrians and cyclists	●	●	●
Active Lane Keeping Assist ³	●	●	●
ADAPTIVE BRAKE with HOLD function, Hill-Start Assist, priming and dry braking in the wet	●	●	●
Airbags – driver and front passenger	●	●	●

	G 63	G 63 Carbon Edition	G 63 Magno Edition
Airbags – front side	●	●	●
Airbags – sidebags in rear	●	●	●
Airbags – windowbags	●	●	●
Anti-lock braking system (ABS) with Brake Assist (BAS)	●	●	●
Anti-theft alarm system with tow-away protection and interior motion sensor (Thatcham Category 1 compliant)	●	●	●
ATTENTION ASSIST – can detect typical symptoms of drowsiness on the basis of driver behaviour and alert the driver to increasing fatigue and inattention	●	●	●
Driving Assistance package ³ consisting of Blind Spot Assist and Distance Assist DISTRONIC	●	●	●
Electronic Stability Programme (ESP®) with Acceleration Skid Control (ASR)	●	●	●
Four-wheel Electronic Traction System (4ETS)	●	●	●
GUARD 360° vehicle protection Plus ¹ – anti-theft protection hardware including alarm and immobilizer. Theft notification and park damage detection ⁴ , stolen vehicle locator ⁴ , 360° surroundview-camera snapshots ⁴ and remote key immobilizer ⁴	●	●	●
Headlight Assist – automatic headlamp activation	●	●	●
i-Size child seat attachment system for outer rear seats	●	●	●
Parking Assist PARKTRONIC	●	●	●
Parking package with 360° camera	●	●	●
PRE-SAFE® system – preventive occupant protection	●	●	●
Service indicator ASSYST	●	●	●
Traffic Sign Assist	●	●	●
Tyre pressure monitoring system	●	●	●

¹The connection of the communication module to the mobile phone network including the emergency call system depends on the respective network coverage and availability of network providers the Owner's Manual and the system limits which are described therein

⁴Free of charge for three years from activation

²Compatible mobile phone required

³Our driver assistance and safety systems are aids and do not relieve you of your responsibility as the driver. Please take note of the information in

Genuine accessories

We've developed a range of Accessories you can add to help personalise and enhance your G-Class.



Mercedes-Benz roof box 450

Impact-resistant, sturdy, durable, recyclable, spray-protected. Opens on both sides. Single lock system with three locking mechanisms on each side. Gas-filled struts for easy opening and closing of lid. Straps to hold contents in place. Maximum load capacity of 75 kg. (A0008401200)



Bicycle rack

Easy to use, convenient and lightweight. Bicycles can be attached at ground level before the rack is fitted. Up to three bicycle carriers can be fitted at one time. The alustyle cycle carrier is designed for the alustyle basic carrier bars, making your life easier, with know-how from Mercedes-Benz. (A0008900293)

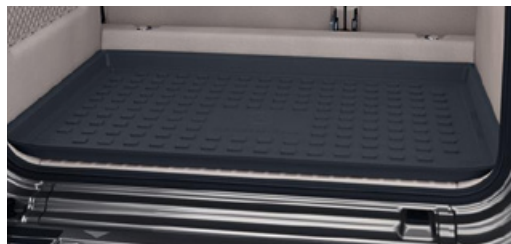

Boot tub, shallow

For your everyday requirements the easy-clean boot tub suits all of your needs. The shape of the tub, with its slightly raised edge, is tailored to the boot with the honeycomb structure preventing slipping. (A4638140000)



Concertina load sill protector

The concertina load sill protector not only protects the boot, but also protects the bumper and boot sill from becoming scratched. As the mat can be folded out, even your clothes stay clean when loading. The load sill guard can be attached via hooks to the lifting eyes or can be attached via a velcro strip to the reversible mat or roof box. (A2536932000)



Basic carrier bars, three crossbars

Aluminium carrier bars, precision-tailored to the body of your Mercedes-Benz – the perfect basis for a range of Mercedes-Benz transport accessories: ski and snowboard rack, bicycle rack or roof boxes. Fitted in next to no time without the use of tools, thanks to new, innovative quick-release fasteners. (A4638902900)



AMG indoor car cover

Silver-coloured, with black AMG lettering. The breathable outer layer in tearproof synthetic fibre and the antistatic inner layer in flannel protect the vehicle against dust and scratches. Elasticated edging at the front and rear ensures that the cover stays in place and provides an ideal fit, particularly for AMG models. (A4638990500)

All the above accessories are subject to availability and compatibility. Please ask your Mercedes-Benz Authorised Repairer for more information

Design	Technology	Model line	Model prices	Mercedes-AMG	Mercedes-AMG prices	Personalisation	Standard equipment	Genuine accessories	Technical data	Additional information
--------	------------	------------	--------------	--------------	---------------------	-----------------	--------------------	---------------------	----------------	------------------------

[Book a test drive](#)[Find your G-Class](#)[Find a Showroom](#)

Technical data

● Standard – Not available

Model	G 400 d		Mercedes-AMG G 63 4MATIC	
Engine				
Fuel delivery	Diesel		Petrol	
Total displacement	cc	2,925	3,982	
Arrangement/cylinders/valves	in-line/6/24		V/8/32	
Power ¹	hp (kW) at rpm	330 (243)/3,600–4,200	585 (430)/6,000	
Torque ¹	Nm at rpm	700/1,200–3,200	850/2,500–3,500	
Compression ratio	15.5:1		8.6:1	
Emissions standard	EURO 6D-ISC-FCM		EURO 6D-ISC-FCM	
Transmission				
9G-TRONIC automatic	●		–	
AMG SPEEDSHIFT PLUS 9G-TRONIC	–		●	
Performance				
Acceleration 0–62 mph	sec	6.4	4.5	
Top speed (electric mode) ²	mph	130	137	
Weights and capacities				
Kerb weight ³	kg	2,701	2,795	
Perm. Gross Vehicle Weight	kg	3,150	3,200	
Boot capacity – seats up	667		667	
seats down	l	1,941	1,941	
Towing capacity – unbraked	750		750	
braked	kg	3,500	3,500	

¹Figures according to Directive 80/1269/EEC in the currently applicable version ²Electronically limited ³Mass of the vehicle in running order with at least 90% full fuel tank, plus the mass of the driver (estimated by law at 75 kg), fuel and fluids, equipped with the standard equipment as specified by the manufacturer as well as, where applicable, the mass of the body, cab, trailer coupling and spare wheel(s) as well as tools. Optional extras, additional equipment and accessories can influence the weight, residual payload, rolling resistance, aerodynamics, etc., and therefore also affect the consumption/CO₂ values

[Book a test drive](#)[Find your G-Class](#)[Find a Showroom](#)

Technical data

Model	G 400 d		Mercedes-AMG G 63 4MATIC	
Weights and capacities (cont.)				
Fuel tank capacity/of which reserve	l	100/12		100/12
Turning circle	m	13.6		13.5
Fuel consumption^{4,5,6}				
Combined (consumption dependent on chosen optional equipment)	l/100 km	11.0		16.2
	mpg	25.7		17.4
Insurance				
Group rating		50P		50P

Insurance ratings may vary depending on model line and specification. Please refer to <http://www.thatcham.org/abigrouprating/> for further details

⁴All figures are based on a standard specification with the smallest tyre size available in the UK

⁵The choice of wheels and transmission may affect CO₂ emissions and corresponding Road Fund Licence

⁶The indicated values were determined according to the prescribed measurement method - Worldwide Harmonised Light Vehicle Test Procedure (WLTP). Figures shown may include options which are not available in the UK



Book a test drive



Find your G-Class



Find a Showroom

AMG Line Premium Plus

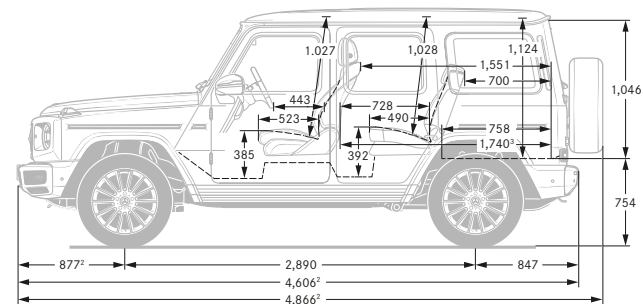
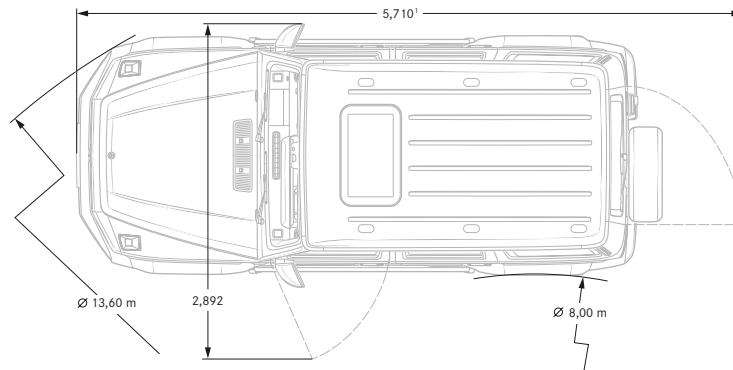
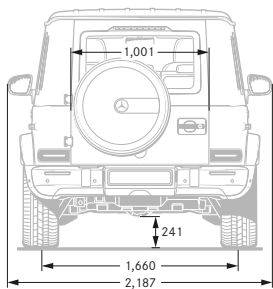
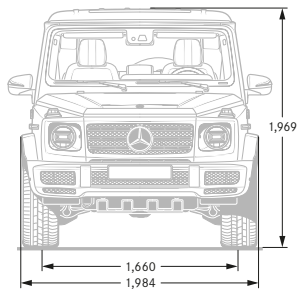

Mercedes-AMG G 63

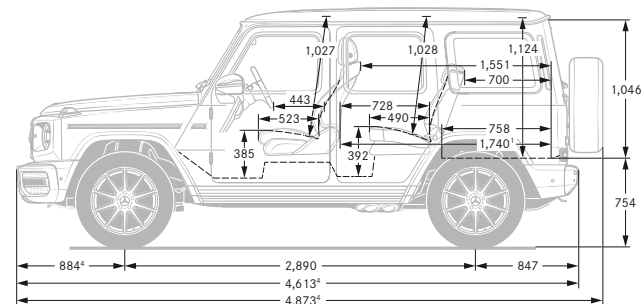
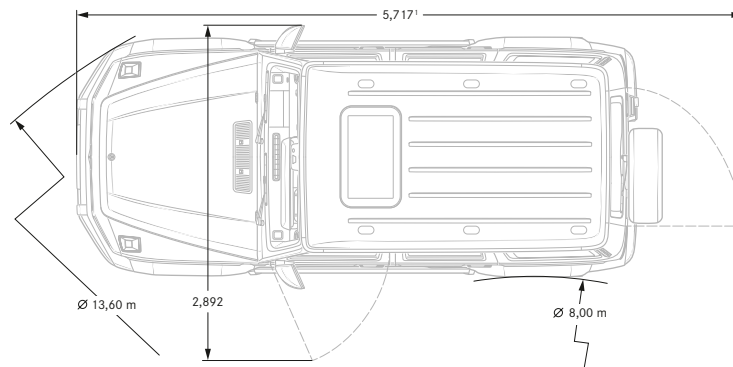
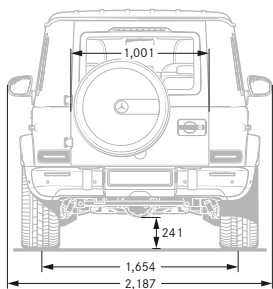
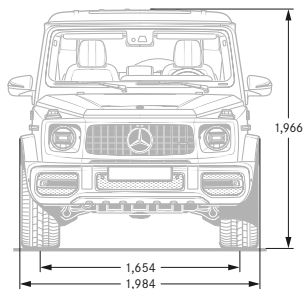

¹Incl. number-plate adapter (8 mm) ²Without number plate adapter (8 mm) ³Measured for an inclination of 14.4° ⁴With trailer tow hitch (optional equipment) All measurements in millimetres. The dimensions shown are mean values and apply to standard-specification, unladen vehicles

Design	Technology	Model line	Model prices	Mercedes-AMG	Mercedes-AMG prices	Personalisation	Standard equipment	Genuine accessories	Technical data	Additional information
--------	------------	------------	--------------	--------------	---------------------	-----------------	--------------------	---------------------	----------------	------------------------



AMG Line Premium Plus – Boot capacity

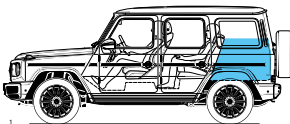

1 Open luggage compartment behind rear seat, loaded to upper edge of rear seat backrest, volume 621 litres, with backrest in cargo position: volume 667 litres

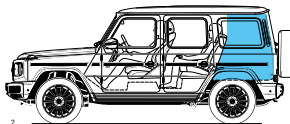

2 Open luggage compartment behind rear seat, loaded to roof, volume 1,031 litres, with backrest in cargo position: volume 1,080 litres

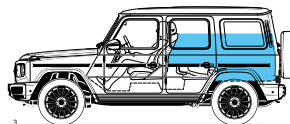

3 Open luggage compartment behind driver's seat, rear seat backrest folded, loaded to upper edge of driver's backrest, volume 1,246 litres

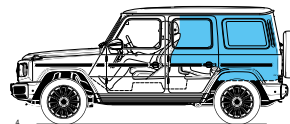

4 Open luggage compartment behind driver's seat, rear seat backrest folded, loaded to roof, volume 1,941 litres

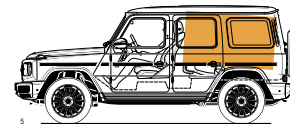

5 Largest cuboid: Dimensions 1,420 x 960 x 50 mm, volume 1,150 litres

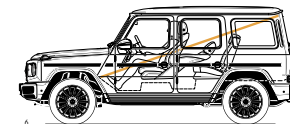

6 Longest board: Dimensions 2,700 x 400 x 30 mm

Mercedes-AMG G 63 – Boot capacity

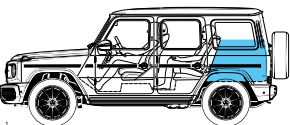

1 Open luggage compartment behind rear seat, loaded to upper edge of rear seat backrest, volume 621 litres, with backrest in cargo position: volume 667 litres

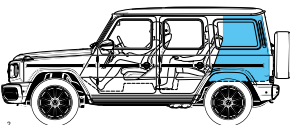

2 Open luggage compartment behind rear seat, loaded to roof, volume 1,031 litres, with backrest in cargo position: volume 1,080 litres

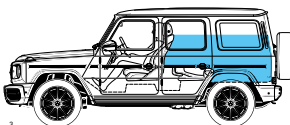

3 Open luggage compartment behind driver's seat, rear seat backrest folded, loaded to upper edge of driver's backrest, volume 1,246 litres

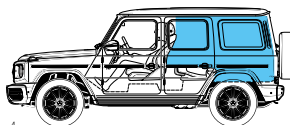

4 Open luggage compartment behind driver's seat, rear seat backrest folded, loaded to roof, volume 1,941 litres

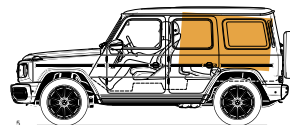

5 Largest cuboid: Dimensions 1,420 x 960 x 850 mm, volume 1,150 litres

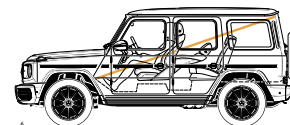

6 Longest board: Dimensions 2,700 x 400 x 30 mm



Road Fund Licence

All road vehicle registrations are subject to Vehicle Excise Duty (Road Fund Licence), which varies in accordance with the vehicle's CO₂ emissions. A first year rate for each taxation band will apply. The table below shows the bands (A–M) created by the DVLA and the corresponding Road Fund Licence. CO₂ emissions and the relevant Excise Duty are shown on the model pricing pages.

Band	CO ₂ emissions (g/km)	First year rate petrol and RDE2 diesel (£)	First year rate alternative fuel (£)	Electric vehicles		Alternative fuel vehicles		Petrol/diesel vehicles	
				Standard rate (£)	Premium rate (£) ¹	Standard rate (£)	Premium rate (£) ¹	Standard rate (£)	Premium rate (£) ¹
A	0	0.00	0.00	0.00	0.00	0.00	0.00	0.00	0.00
B	1 to 50	10.00	0.00	0.00	0.00	170.00	560.00	180.00	570.00
C	51 to 75	30.00	20.00	0.00	0.00	170.00	560.00	180.00	570.00
D	76 to 90	130.00	120.00	0.00	0.00	170.00	560.00	180.00	570.00
E	91 to 100	165.00	155.00	0.00	0.00	170.00	560.00	180.00	570.00
F	101 to 110	185.00	175.00	0.00	0.00	170.00	560.00	180.00	570.00
G	111 to 130	210.00	200.00	0.00	0.00	170.00	560.00	180.00	570.00
H	131 to 150	255.00	245.00	0.00	0.00	170.00	560.00	180.00	570.00
I	151 to 170	645.00	635.00	0.00	0.00	170.00	560.00	180.00	570.00
J	171 to 190	1,040.00	1,030.00	0.00	0.00	170.00	560.00	180.00	570.00
K	191 to 225	1,565.00	1,555.00	0.00	0.00	170.00	560.00	180.00	570.00
L	226 to 255	2,220.00	2,210.00	0.00	0.00	170.00	560.00	180.00	570.00
M	over 255	2,605.00	2,595.00	0.00	0.00	170.00	560.00	180.00	570.00



Some of the model features, optional extras and colours shown may not be available, or may only be available in a different specification
¹Premium rate only applicable to vehicles where the list price is over £40,000 including any factory-fitted options, standard UK delivery charge and VAT

Services and insurance

Mercedes-Benz ServiceCare

We believe that servicing costs should be as flexible and affordable as possible for your G-Class, which is why we offer ServiceCare, an easy way to budget for all your servicing costs. It spreads your bills into manageable payments based on whether you have a new or used Mercedes-Benz. With ServiceCare we guarantee the price of parts and labour for up to four services and safeguard against any further inflation. It also covers the cost of all recommended service items including brake fluid, spark plugs, air filters, fuel filters and screen wash. You can choose either to add your servicing costs into your monthly spend or pay the full amount in a one-off payment, giving you peace of mind that they are taken care of for the period of the plan.

[Click here for more information](#)

Warranty and breakdown cover

Every Mercedes-Benz comes with a three-year unlimited mileage warranty against manufacturing or material defects¹ and up to 30 years warranty against perforation due to corrosion from the inside out.² What's more, it's also covered by Mercedes-Benz Roadside Assistance – a unique package comprising up to 30 years pan-European breakdown assistance.²

Motor Insurance

We know that once you have chosen your Mercedes-Benz you can't wait to drive it – that's why we created First Cover³. It gives you 7 days' free comprehensive Motor Insurance when you buy a new or used vehicle from a Mercedes-Benz Agent. We will also send you a quote for annual cover, so you can enjoy the same peace of mind all year round.

[Apply for First Cover](#)

¹Applies to vehicles sold by Mercedes-Benz in the UK to its franchised Mercedes-Benz Agents ²Subject to full Terms and Conditions, dependent on date of registration, available upon request
³Terms and Conditions apply. We are an independent intermediary dealing with selected insurers in respect of annual insurance



Effective from September 2023 Production. Information correct at time of publication 27.06.2023.
Prices and specifications are subject to change without prior notice.
MBW463PL/1023 MYX23

