



# The new CLE Coupé

Effective from November 2023 Production.

Mercedes-Benz





Some of the model features, optional extras and colours shown may not be available, or may only be available in a different specification, or at a different price.

Design	Technology	Model lines	Upholstery	Model prices	Personalisation	Standard equipment	Technical data	Additional information
--------	------------	-------------	------------	--------------	-----------------	--------------------	----------------	------------------------





Some of the model features, optional extras and colours shown may not be available, or may only be available in a different specification, or at a different price.

<a href="#">Design</a>	<a href="#">Technology</a>	<a href="#">Model lines</a>	<a href="#">Upholstery</a>	<a href="#">Model prices</a>	<a href="#">Personalisation</a>	<a href="#">Standard equipment</a>	<a href="#">Technical data</a>	<a href="#">Additional information</a>
------------------------	----------------------------	-----------------------------	----------------------------	------------------------------	---------------------------------	------------------------------------	--------------------------------	--



Some of the model features, optional extras and colours shown may not be available, or may only be available in a different specification, or at a different price.

<a href="#">Design</a>	<a href="#">Technology</a>	<a href="#">Model lines</a>	<a href="#">Upholstery</a>	<a href="#">Model prices</a>	<a href="#">Personalisation</a>	<a href="#">Standard equipment</a>	<a href="#">Technical data</a>	<a href="#">Additional information</a>
------------------------	----------------------------	-----------------------------	----------------------------	------------------------------	---------------------------------	------------------------------------	--------------------------------	--





CLE  
Technology

# DIGITAL LIGHT

High-definition headlamps with innovative features

● Standard    – Not available

The new innovative DIGITAL LIGHT headlamps works like a projector with more than one million pixels per headlamp and responds with brilliant light to changing traffic, road or weather conditions. Its ULTRA RANGE Highbeam with 650 m makes you feel like driving at daylight. DIGITAL LIGHT is also able to provide assistance in the form of messages on the road in front of you.<sup>1</sup>

<sup>1</sup>This additional function depends on local road traffic laws

Model line	DIGITAL LIGHT
AMG Line	–
AMG Line Premium	●
AMG Line Premium Plus	●
Premier Edition	●





# Mercedes-Benz User Experience (MBUX)

Transforming the in-car user experience, thanks to MBUX: Controlled via voice or touch input, the innovative infotainment system can over time even predict personal habits thanks to artificial intelligence.

## Voice control

- Activated by the keywords “Hey Mercedes”, the new intelligent voice control LINGUATRONIC<sup>1</sup> lets you control many of the infotainment functions, including destination input, phone calls or music selection
- MBUX is able to understand different accents and will adjust to you over time
- MBUX even understands indirect commands. Feeling chilly? Just say “I feel cold” and MBUX will adjust the temperature for you

## Touch inputs

- Beside voice control you can operate MBUX via touchscreen as well as touch control buttons on the steering wheel

## Personalisation

- Turn the new CLE into your very own Mercedes-Benz by personalising driving modes, radio stations and much more
- Your personal settings can be saved in up to seven different profiles, making your driving experience the best one possible
- Thanks to artificial intelligence, MBUX is able to learn and adapt over time. It will be able to predict your personal habits, such as navigation for frequently-driven routes, or the radio station you like to listen to on your way home from work

## Maintenance and service

- Wondering when the next service is due? Or how much further you can drive until you need to stop at a petrol station? Just ask your MBUX – it will tell you the answer



The connection of the communication module to the mobile phone network including the emergency call system depends on the respective network coverage and availability of network providers

<sup>1</sup>LINGUATRONIC off-board functions are currently only available for three years

Design	Technology	Model lines	Upholstery	Model prices	Personalisation	Standard equipment	Technical data	Additional information
--------	------------	-------------	------------	--------------	-----------------	--------------------	----------------	------------------------

# Mercedes me connect

 Stay connected any time, anywhere.

# Mercedes me

Mercedes me is a range of innovative online services designed to enhance your Mercedes-Benz experience. Accessible via mobile, tablet or PC, Mercedes me lets you enjoy the highest standards of care and support, in a way that integrates seamlessly with your busy lifestyle.

## Safety and Service – Mercedes me connect helps to keep you and your car safe

Check your car's oil level, tyre pressure and fuel from your phone so you'll be ready for every journey.

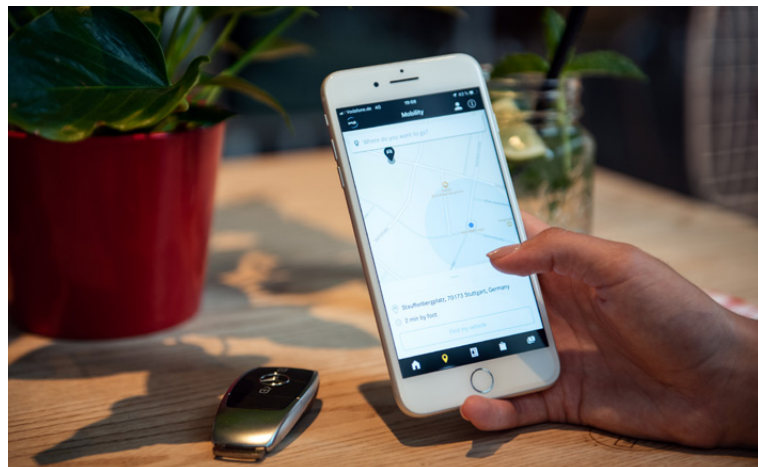

## Live Traffic Information, Parked Vehicle Locator and much more with Mercedes me connect

Forgot where you've parked? Parked Vehicle Locator<sup>1</sup> will show you exactly where your car is as long as you're in a 1-mile radius of where you parked. Real-time traffic data and dynamic route with shorter journey times.

For more information speak to your local Mercedes-Benz Agent or visit the Mercedes me connect store at [shop.mercedes-benz.com/en-gb/connect](http://shop.mercedes-benz.com/en-gb/connect)

## Comfort – connect to your car anytime, anywhere

Forgot to lock your car? With Remote Car Lock<sup>2</sup> you will receive a notification on your smartphone to let you know. With one tap, you can lock and unlock your vehicle so you never have to worry.

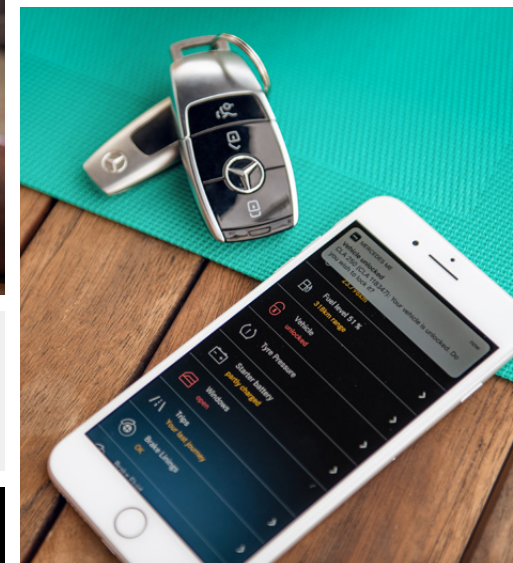

<sup>1</sup>The connection of the communication module to the mobile phone network including the emergency call system depends on the respective network coverage and availability of network providers

<sup>2</sup>Available on all models with the Vehicle Monitoring package. This option may vary between standard and additional cost dependent on the model

<sup>3</sup>Part of the Vehicle Status package. This option may vary between standard and additional cost dependent on the model

Images shown are for illustration purposes only



# CLE Model lines overview

**AMG Line »**



**AMG Line Premium »**



**AMG Line Premium Plus »**



**Premier Edition »**



# AMG Line Standard equipment highlights



## Engine, Transmission and Suspension

AGILITY CONTROL sports suspension – lowered by 15 mm

DYNAMIC SELECT with a choice of driving modes: 'Eco', 'Comfort', 'Sport', 'Sport+' and 'Individual'

OTR from **£46,605<sup>1</sup>**

<sup>1</sup>The recommended on-the-road price includes the Road Fund Licence applicable to the standard model plus delivery charge (£730.00 incl. VAT), new vehicle registration fee (£55.00), fuel (£50.00 incl. VAT), and number plates (£25.00 incl. VAT). VAT is calculated at the standard rate of 20%. Some of the model features, optional extras and colours shown may not be available, or may only be available in a different specification, or at a different price



## Exterior

18" AMG alloy wheels – 5-twin-spoke design, aerodynamically optimised, painted black with a high-sheen finish (code RSK)

Ambient lighting with projection of brand logo

AMG Line exterior

Heat-insulating, dark-tinted glass

LED High-Performance headlamps with Adaptive Highbeam Assist

Mirror package – electrically-folding exterior mirrors and automatically-dimming rear-view mirror

Summer tyres







No-cost option shown: leather - macchiato beige/black (code 205A)



Memory package

**Interior**

Ambient Lighting Premium

AMG Line interior

Illuminated door sill panels with 'Mercedes-Benz' lettering

Interior Light package

KEYLESS-GO

Memory package

Seats – four-way lumbar support

Seats – heated, front

THERMATIC automatic climate control

**Communications and In-Car Entertainment**

Dashcam

Smartphone integration<sup>1</sup> including Apple CarPlay® and Android Auto™

USB package Plus

Wireless charging<sup>1</sup>

<sup>1</sup>Compatible mobile phone required

**Safety and Assistance Systems**

Blind Spot Assist

Parking package with reversing camera

Traffic Sign Assist

**Trim and Upholstery**

Anthracite linestructure wood trim

Leather – black

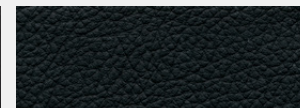
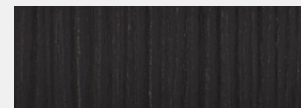

# AMG Line Premium Standard equipment highlights



Option shown: high-tech silver metallic (code 922)

OTR from **£50,355<sup>1</sup>**  
Upgrade price from AMG Line **£3,750**

<sup>1</sup>The recommended on-the-road price includes the Road Fund Licence applicable to the standard model plus delivery charge (£730.00 incl. VAT), new vehicle registration fee (£55.00), fuel (£50.00 incl. VAT), and number plates (£25.00 incl. VAT). VAT is calculated at the standard rate of 20%. Some of the model features, optional extras and colours shown may not be available, or may only be available in a different specification, or at a different price



Option shown: high-tech silver metallic (code 922)

In addition to/replacement of AMG Line:

#### Exterior

19" AMG alloy wheels – multi-spoke design, aerodynamically optimised, painted black with a high-sheen finish (code RVA)

DIGITAL LIGHT with Adaptive Highbeam Assist Plus

KEYLESS-GO Comfort package

Panoramic sliding sunroof

Summer tyres







No-cost option shown: leather - tonka brown/black (code 204A)

### Communications and In-Car Entertainment

MBUX augmented reality for navigation



### Safety and Assistance Systems

Parking package with 360° camera

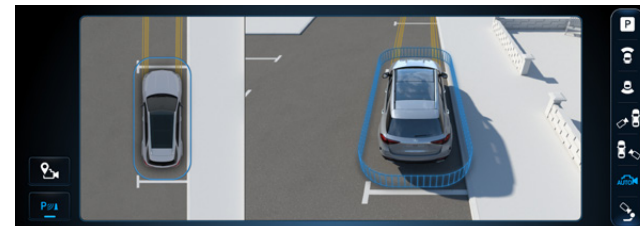

### Trim and Upholstery

Anthracite linestructure wood trim

Leather - black

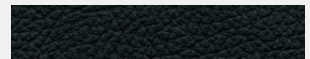
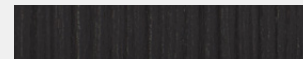

# AMG Line Premium Plus

Standard equipment highlights



Option shown: MANUFAKTUR alpine grey solid (code 956)



Option shown: MANUFAKTUR alpine grey solid (code 956)

In addition to/replacement of AMG Line Premium:

#### Exterior

20" AMG alloy wheels - multi-spoke design, aerodynamically optimised, painted black with a high-shine finish (code RVM)

Summer tyres



OTR from **£54,355<sup>1</sup>**  
Upgrade price from AMG Line Premium **£4,000**

<sup>1</sup>The recommended on-the-road price includes the Road Fund Licence applicable to the standard model plus delivery charge (£730.00 incl. VAT), new vehicle registration fee (£55.00), fuel (£50.00 incl. VAT), and number plates (£25.00 incl. VAT). VAT is calculated at the standard rate of 20%. Some of the model features, optional extras and colours shown may not be available, or may only be available in a different specification, or at a different price





Burmester® 3D surround sound system



Energizing Plus package

**Interior**

AIR BALANCE package

Energizing package Plus

Seats – multi-contour and climatized, front

**Communications and In-Car Entertainment**

Head-up display

Burmester® 3D surround sound system with sound personalisation

**Trim and Upholstery**

Black open-pore aluminium lines  
wood trim

Leather – black

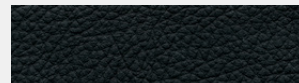
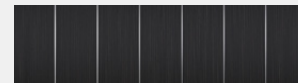

# Premier Edition equipment highlights



Option shown: MANUFAKTUR patagonia red metallic (code 993)



Option shown: MANUFAKTUR patagonia red metallic (code 993)

In addition to/replacement of AMG Line Premium Plus:

#### Exterior

20" AMG alloy wheels – multi-spoke design, aerodynamically optimised, painted black with a high-sheen rim flange (code RVN)

Night package

Summer tyres



OTR from **£56,855<sup>1</sup>**  
Upgrade price from AMG Line Premium Plus **£2,500**

<sup>1</sup>The recommended on-the-road price includes the Road Fund Licence applicable to the standard model plus delivery charge (£730.00 incl. VAT), new vehicle registration fee (£55.00), fuel (£50.00 incl. VAT), and number plates (£25.00 incl. VAT). VAT is calculated at the standard rate of 20%. Some of the model features, optional extras and colours shown may not be available, or may only be available in a different specification, or at a different price





No-cost option shown: nappa leather - white/black (code 809A)

### Interior

Heated steering wheel



Heated steering wheel

### Trim and Upholstery

Carbon fibre trim

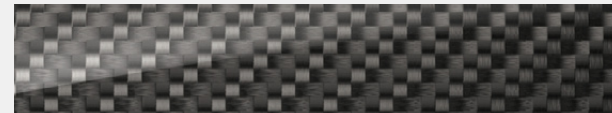

Nappa leather - black

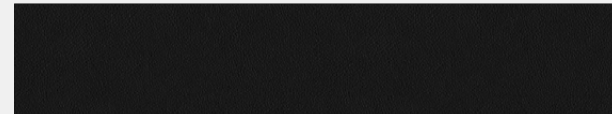



# Upholstery

● Standard   □ No-cost option   – Not available



**201A Leather<sup>1</sup> – black**

AMG Line	●
AMG Line Premium	●
AMG Line Premium Plus	●
Premier Edition	–



**204A Leather<sup>1</sup> – tonka brown/black**

AMG Line	□
AMG Line Premium	□
AMG Line Premium Plus	□
Premier Edition	–



**205A Leather<sup>1</sup> – macchiato beige/black**

AMG Line	□
AMG Line Premium	□
AMG Line Premium Plus	□
Premier Edition	–



**207A Leather<sup>1</sup> – power red/black**

AMG Line	□
AMG Line Premium	□
AMG Line Premium Plus	□
Premier Edition	–

<sup>1</sup>At least 80% of the seat upholstery is pure leather, while up to 20% may consist of man-made leather

# Upholstery

Standard
  No-cost option
  Not available



**801A Nappa leather<sup>1</sup> – black**

AMG Line	–
AMG Line Premium	–
AMG Line Premium Plus	–
Premier Edition	●



**804A Nappa leather<sup>1</sup> – tonka brown/black**

AMG Line	–
AMG Line Premium	–
AMG Line Premium Plus	–
Premier Edition	□



**809A Nappa leather<sup>1</sup> – white/black**

AMG Line	–
AMG Line Premium	–
AMG Line Premium Plus	–
Premier Edition	□

<sup>1</sup>100% of seat upholstery is pure leather

# Model prices

Model line	Engine	Transmission	CO <sub>2</sub> WLTP <sup>1</sup>	Basic RRP excl. VAT (£)	Total RRP incl. VAT (£)	Road Fund Licence (£) <sup>2</sup> WLTP	Rec. OTR price (£) <sup>3</sup> WLTP	P11D value (£)	BiK tax rate 2023/24 (%) <sup>2</sup>
<b>AMG Line</b>									
CLE200	Petrol - 1,999 cc, 4-cylinder, 204 hp/150 kW Mild hybrid drive 17 kW	9G-TRONIC PLUS 9-speed auto.	145	37,916.67	45,500.00	245.00	<b>46,605.00</b>	46,305.00	34
CLE220 d	Diesel - 1,993 cc, 4-cylinder, 197 hp/145 kW Mild hybrid drive 17 kW	9G-TRONIC PLUS 9-speed auto.	123	40,000.00	48,000.00	200.00	<b>49,060.00</b>	48,805.00	29
<b>AMG Line Premium</b>									
CLE200	Petrol - 1,999 cc, 4-cylinder, 204 hp/150 kW Mild hybrid drive 17 kW	9G-TRONIC PLUS 9-speed auto.	148	41,041.67	49,250.00	245.00	<b>50,355.00</b>	50,055.00	34
CLE300 4MATIC	Petrol - 1,999 cc, 4-cylinder, 258 hp/190 kW Mild hybrid drive 17 kW	9G-TRONIC PLUS 9-speed auto.	162	45,208.33	54,250.00	635.00	<b>55,745.00</b>	55,055.00	37
CLE450 4MATIC	Petrol - 2,999 cc, 6-cylinder, 381 hp/280 kW Mild hybrid drive 17 kW	9G-TRONIC PLUS 9-speed auto.	176	53,645.83	64,375.00	1,030.00	<b>66,265.00</b>	65,180.00	37
CLE 220 d	Diesel - 1,993 cc, 4-cylinder, 197 hp/145 kW Mild hybrid drive 17 kW	9G-TRONIC PLUS 9-speed auto.	125	43,125.00	51,750.00	200.00	<b>52,810.00</b>	52,555.00	30

<sup>1</sup>The indicated values were determined according to the prescribed measurement method - Worldwide Harmonised Light Vehicle Test Procedure (WLTP). Figures shown may include options which are not available in the UK. Figures shown are for comparability purposes; only compare with other cars tested to the same technical procedures. Figures may not reflect real life driving results, which will depend upon a number of factors including the starting charge of the battery, factory-fitted options, accessories fitted (post registration), variations in weather, driving styles and vehicle load. Further information about the test used to establish fuel consumption and CO<sub>2</sub> figures can be found at <http://www.mercedes-benz.co.uk/WLTP> <sup>2</sup>A different first year rate of Vehicle Excise Duty (Road Fund Licence) applies for new cars. Please refer to page 31 for the relevant rate for the second and subsequent years <sup>3</sup>The recommended on-the-road price includes the Road Fund Licence applicable to the standard model plus delivery charge (£730.00 incl. VAT), new vehicle registration fee (£55.00), fuel (£50.00 incl. VAT), and number plates (£25.00 incl. VAT). VAT is calculated at the standard rate of 20%. Some of the model features, optional extras and colours shown may not be available, or may only be available in a different specification, or at a different price

Design	Technology	Model lines	Upholstery	Model prices	Personalisation	Standard equipment	Technical data	Additional information
--------	------------	-------------	------------	--------------	-----------------	--------------------	----------------	------------------------



# Model prices

Model line	Engine	Transmission	CO <sub>2</sub> WLTP <sup>1</sup>	Basic RRP excl. VAT (£)	Total RRP incl. VAT (£)	Road Fund Licence (£) <sup>2</sup> WLTP	Rec. OTR price (£) <sup>3</sup> WLTP	P11D value (£)	BiK tax rate 2023/24 (%) <sup>2</sup>
<b>AMG Line Premium Plus</b>									
CLE200	Petrol – 1,999 cc, 4-cylinder, 204 hp/150 kW Mild hybrid drive 17 kW	9G-TRONIC PLUS 9-speed auto.	147	44,375.00	53,250.00	245.00	<b>54,355.00</b>	54,055.00	34
CLE300 4MATIC	Petrol – 1,999 cc, 4-cylinder, 258 hp/190 kW Mild hybrid drive 17 kW	9G-TRONIC PLUS 9-speed auto.	161	48,541.67	58,250.00	635.00	<b>59,745.00</b>	59,055.00	37
CLE450 4MATIC	Petrol – 2,999 cc, 6-cylinder, 381 hp/280 kW Mild hybrid drive 17 kW	9G-TRONIC PLUS 9-speed auto.	176	56,979.17	68,375.00	1,030.00	<b>70,265.00</b>	69,180.00	37
CLE220 d	Diesel – 1,993 cc, 4-cylinder, 197 hp/145 kW Mild hybrid drive 17 kW	9G-TRONIC PLUS 9-speed auto.	125	46,458.33	55,750.00	200.00	<b>56,810.00</b>	56,555.00	30
<b>Premier Edition</b>									
CLE200	Petrol – 1,999 cc, 4-cylinder, 204 hp/150 kW Mild hybrid drive 17 kW	9G-TRONIC PLUS 9-speed auto.	148	46,458.33	55,750.00	245.00	<b>56,855.00</b>	56,555.00	34
CLE300 4MATIC	Petrol – 1,999 cc, 4-cylinder, 258 hp/190 kW Mild hybrid drive 17 kW	9G-TRONIC PLUS 9-speed auto.	162	50,625.00	60,750.00	635.00	<b>62,245.00</b>	61,555.00	37
CLE450 4MATIC	Petrol – 2,999 cc, 6-cylinder, 381 hp/280 kW Mild hybrid drive 17 kW	9G-TRONIC PLUS 9-speed auto.	176	59,062.50	70,875.00	1,030.00	<b>72,765.00</b>	71,680.00	37
CLE220 d	Diesel – 1,993 cc, 4-cylinder, 197 hp/145 kW Mild hybrid drive 17 kW	9G-TRONIC PLUS 9-speed auto.	126	48,541.67	58,250.00	200.00	<b>59,310.00</b>	59,055.00	30

<sup>1</sup>The indicated values were determined according to the prescribed measurement method - Worldwide Harmonised Light Vehicle Test Procedure (WLTP). Figures shown may include options which are not available in the UK. Figures shown are for comparability purposes; only compare with other cars tested to the same technical procedures. Figures may not reflect real life driving results, which will depend upon a number of factors including the starting charge of the battery, factory-fitted options, accessories fitted (post registration), variations in weather, driving styles and vehicle load. Further information about the test used to establish fuel consumption and CO<sub>2</sub> figures can be found at <http://www.mercedes-benz.co.uk/WLTP> <sup>2</sup>A different first year rate of Vehicle Excise Duty (Road Fund Licence) applies for new cars. Please refer to page 31 for the relevant rate for the second and subsequent years <sup>3</sup>The recommended on-the-road price includes the Road Fund Licence applicable to the standard model plus delivery charge (£730.00 incl. VAT), new vehicle registration fee (£55.00), fuel (£50.00 incl. VAT), and number plates (£25.00 incl. VAT). VAT is calculated at the standard rate of 20%. Some of the model features, optional extras and colours shown may not be available, or may only be available in a different specification, or at a different price

# Colour options

Non-metallic, metallic and MANUFAKTUR paints

● Standard

Total prices incl. VAT



149 polar white non-metallic



197 obsidian black metallic

£715



970 spectral blue metallic

£715



885 MANUFAKTUR opalite white bright metallic

£925



831 graphite grey metallic

£715



956 MANUFAKTUR alpine grey solid

£925



922 high-tech silver metallic

£715



993 MANUFAKTUR patagonia red metallic















£925

Please note that, owing to limitations of on-screen representation, paint colours may differ from those shown

Design	Technology	Model lines	Upholstery	Model prices	Personalisation	Standard equipment	Technical data	Additional information
--------	------------	-------------	------------	--------------	-----------------	--------------------	----------------	------------------------

# Combination options

● Possible    – Not possible

		Interior upholstery colours							
		AMG Line, AMG Line Premium and AMG Line Premium Plus				Premier Edition			
									
	201A Leather <sup>1</sup> – black	204A Leather <sup>1</sup> – tonka brown/black	205A Leather <sup>1</sup> – macchiato beige/black	207A Leather <sup>1</sup> – power red/black	801A Nappa leather <sup>2</sup> – black	804A Nappa leather <sup>2</sup> – tonka brown/black	809A Nappa leather <sup>2</sup> – white/black		
Exterior paint colours		149 polar white non-metallic	●	–	–	–	●	–	–
		197 obsidian black metallic	●	●	●	●	●	●	●
		831 graphite grey metallic	●	●	●	●	●	●	●
		922 high-tech silver metallic	●	●	–	●	●	●	–
		970 spectral blue metallic	●	–	●	–	●	–	●
		885 MANUFAKTUR opalite white bright metallic	●	●	–	●	●	●	●
		956 MANUFAKTUR alpine grey solid	●	●	–	●	●	●	●
		993 MANUFAKTUR patagonia red	●	–	●	–	●	–	●

<sup>1</sup>At least 80% of the seat upholstery is pure leather, while up to 20% may consist of man-made leather

<sup>2</sup>100% of seat upholstery is pure leather



# Driving Assistance package Plus<sup>1</sup>

The Driving Assistance package Plus<sup>1</sup> contains a range of highly intelligent features to help you stay safe on the road – by making the drive more effortless, by warning of danger, and by taking steps to protect you in an emergency.

**Driving Assistance package Plus<sup>1</sup>** (code P20) – designed and priced as a package, including items listed below.

**Only available for AMG Line Premium Plus and Premier Edition**

**Total incl. VAT £1,695.00**

**Active Blind Spot Assist:** can warn the driver of vehicles in the blind spot during a lane change and can help to avoid a collision by means of one-sided braking intervention

**Active Braking Assist** with cross-traffic function can help to avoid accidents with vehicles ahead, crossing traffic and also pedestrians, and/or mitigate their consequences

**Active Distance Assist DISTRONIC** helps maintain the desired distance from the vehicle in front with extended automatic re-start on motorways

**Active Lane Change Assist** supports you by bringing you into the parallel lane if there is space when changing lanes

**Active Speed Limit Assist** ensures detected speed limits are automatically adopted as the set speed for Active Distance Assist DISTRONIC

**Evasive Steering Assist** can support the driver in making evasive manoeuvres if, in a dangerous situation, he/she moves to avoid any pedestrian detected by the system

**PRE-SAFE®** can prepare the occupants for a side-on collision and reduce the risk of injury. Like a bodyguard, it pushes the driver or front passenger away from the danger zone towards the inside

**PRE-SAFE® PLUS** when a rear-end collision threatens, PRE-SAFE® PLUS can initiate preventive measures, including warning following traffic and locking the brakes on standstill

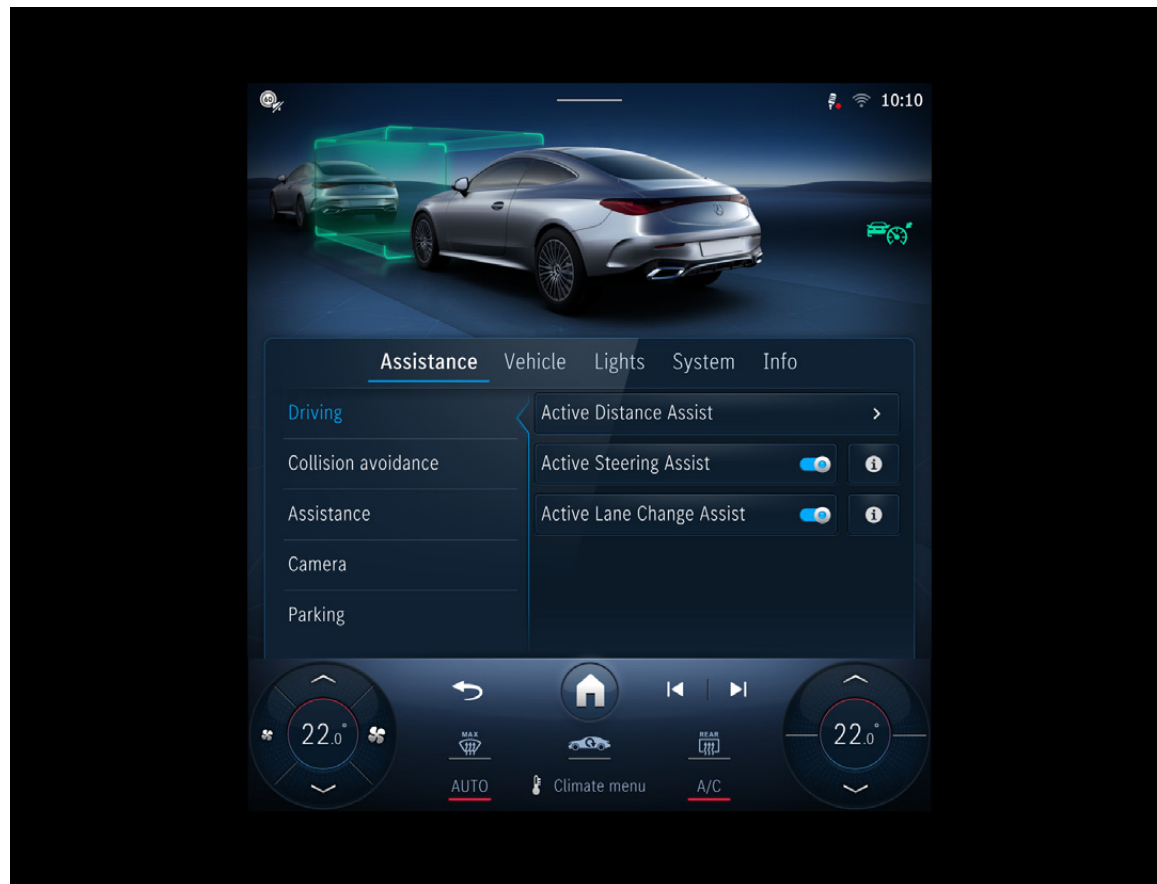

<sup>1</sup>Our driver assistance and safety systems are aids and do not relieve you of your responsibility as the driver. Please take note of the information in the Owner's Manual and the system limits which are described therein

Design	Technology	Model lines	Upholstery	Model prices	Personalisation	Standard equipment	Technical data	Additional information
--------	------------	-------------	------------	--------------	-----------------	--------------------	----------------	------------------------

# Standard equipment

● Standard – Not available

## Engine, Transmission and Suspension

	AMG Line	AMG Line Premium	AMG Line Premium Plus	Premier Edition
9G-TRONIC PLUS 9-speed automatic transmission	●	●	●	●
AGILITY CONTROL sports suspension – lowered by 15 mm	●	●	●	●
DYNAMIC SELECT with a choice of driving modes (Comfort, ECO, Sport, Sport+, Individual)	●	●	●	●
Integrated Starter Generator Generation 2	●	●	●	●

## Exterior

Ambient lighting with projection of brand logo	●	●	●	●
AMG Line exterior	●	●	●	●
Braking system with larger brake discs on front axle	●	●	●	●
Fuel tank – 66-litres	●	●	●	●
Headlamps – DIGITAL LIGHT with Adaptive Highbeam Assist Plus	–	●	●	●
Headlamps – LED High-Performance headlamps with Adaptive Highbeam Assist	●	–	–	–
Heat-insulating, dark-tinted glass	●	●	●	●
KEYLESS-GO Comfort package	–	●	●	●
Mirror package – electrically-folding exterior mirrors and automatically-dimming rear-view mirror	●	●	●	●
Night package	–	–	–	●
Panoramic sliding sunroof	–	●	●	●
Sporty engine sound	●	●	●	●
Windscreen wipers with rain sensor	●	●	●	●

## Interior

	AMG Line	AMG Line Premium	AMG Line Premium Plus	Premier Edition
AIR BALANCE package	–	–	●	●
Ambient Lighting Premium	●	●	●	●
AMG floor mats	●	●	●	●
AMG Line interior	●	●	●	●
Belt feeder	●	●	●	●
Energizing package Plus	–	–	●	●
Heated steering wheel	–	–	–	●
Illuminated door sill panels with ‘Mercedes-Benz’ lettering	●	●	●	●
Interior Light package	●	●	●	●
KEYLESS-GO	●	●	●	●
KEYLESS-GO starting function	●	●	●	●
Seats – folding backrests, rear	●	●	●	●
Seats – four-way lumbar support	●	●	–	–
Seats – heated, front	●	●	●	●
Seats – Memory package	●	●	●	●
Seats – multi-contour and climatized, front	–	–	●	●
Stowage Space package	●	●	●	●
THERMATIC automatic climate control	●	●	●	●

# Standard equipment

● Standard – Not available

## Wheels

	AMG Line	AMG Line Premium	AMG Line Premium Plus	Premier Edition
18" AMG alloy wheels – 5-twin-spoke design, aerodynamically optimised, painted black with a high-sheen finish, with 245/45 R18 tyres (front) and 275/40 R18 tyres (rear)	●	–	–	–
19" AMG alloy wheels – multi-spoke design, aerodynamically optimised, painted black with a high-sheen finish, with 245/40 R19 tyres (front) and 275/35 R19 tyres (rear)	–	●	–	–
20" AMG alloy wheels – multi-spoke design, aerodynamically optimised, painted black with a high-sheen finish, with 245/35 R20 (front) and 275/30 R20 (rear)	–	–	●	–
20" AMG alloy wheels – multi-spoke design, aerodynamically optimised, painted black with a high-sheen rim flange, with 245/35 R20 (front) and 275/30 R20 (rear)	–	–	–	●
Summer tyres	●	●	●	●

## Paint, Trim and Upholstery

	AMG Line	AMG Line Premium	AMG Line Premium Plus	Premier Edition
Centre console – high-gloss black	–	–	–	●
Centre console – mixed fabric-look finish with metal effect	●	●	●	–
Instrument panel and beltlines in ARTICO man-made leather in nappa look	●	●	●	●
Paint – non-metallic	●	●	●	●
Roof lining – black fabric	●	●	●	●
Trim – AMG carbon fibre	–	–	–	●
Trim – anthracite linestructure lime wood	●	●	–	–
Trim – black open-pore aluminium line wood trim	–	–	●	–
Upholstery – leather	●	●	●	–
Upholstery – nappa leather	–	–	–	●

## Steering

	AMG Line	AMG Line Premium	AMG Line Premium Plus	Premier Edition
Multifunction sport steering wheel in nappa leather	●	●	●	●
Steering column – electrically adjustable for height and reach	●	●	●	●

## Safety and Assistance Systems

	AMG Line	AMG Line Premium	AMG Line Premium Plus	Premier Edition
Active Brake Assist <sup>1</sup>	●	●	●	●
Active Lane Keeping Assist <sup>1</sup>	●	●	●	●
Anti-theft alarm system	●	●	●	●
Blind Spot Assist <sup>1</sup>	●	●	●	●
Centre airbag	●	●	●	●
Fingerprint scanner	●	●	●	●
Fluorescent jacket for driver	●	●	●	●
Increased anti-theft protection	●	●	●	●
Interior monitoring system	●	●	●	●
GUARD 360° vehicle protection <sup>2</sup>	●	●	●	●
Passive person presence reminder	●	●	●	●
Parking – Active Parking Assist <sup>1</sup> with PARKTRONIC	●	●	●	●
Parking – Parking package with reversing camera	●	–	–	–
Parking – Parking package with 360° camera	–	●	●	●
Pedestrian protection	●	●	●	●

<sup>1</sup>Our driver assistance and safety systems are aids and do not relieve you of your responsibility as the driver. Please take note of the information in the Owner's Manual and the system limits which are described therein of network providers

<sup>2</sup>The connection of the communication module to the mobile phone network including the emergency call system depends on the respective network coverage and availability



# Standard equipment

● Standard    – Not available

## Safety and Assistance Systems (continued)

	AMG Line	AMG Line Premium	AMG Line Premium Plus	Premier Edition
Traffic Sign Assist <sup>1</sup> – traffic sign recognition including wrong-way warning function and display of posted speed limits in the instrument cluster	●	●	●	●
Tyre pressure monitoring system	●	●	●	●

## Communications and In-Car Entertainment

	AMG Line	AMG Line Premium	AMG Line Premium Plus	Premier Edition
5G communications module <sup>2</sup> for the use of Mercedes me connect services	●	●	●	●
11.9-inch media display screen	●	●	●	●
12.3-inch driver display screen	●	●	●	●
Burmester® 3D surround sound with sound personalisation	–	–	●	●
DAB digital radio	●	●	●	●
Dashcam	●	●	●	●
Extended MBUX functions	●	●	●	●
Fingerprint Scanner	●	●	●	●
Hard-disk navigation	●	●	●	●
Head-up display	–	–	●	●

	AMG Line	AMG Line Premium	AMG Line Premium Plus	Premier Edition
MBUX augmented reality for navigation	–	●	●	●
MBUX multimedia system <sup>3</sup>	●	●	●	●
MBUX Navigation Premium <sup>2</sup>	●	●	●	●
Smartphone integration <sup>4</sup> including Apple CarPlay® and Android Auto™	●	●	●	●
USB package Plus	●	●	●	●
Wireless charging for mobile devices in the front <sup>4</sup>	●	●	●	●

<sup>1</sup>Our driver assistance and safety systems are aids and do not relieve you of your responsibility as the driver. Please take note of the information in the Owner's Manual and the system limits which are described therein    <sup>2</sup>The connection of the communication module to the mobile phone network including the emergency call system depends on the respective network coverage and availability of network providers    <sup>3</sup>LINGUATRONIC off-board functions are currently only available for three years    <sup>4</sup>Compatible mobile phone required. Please check [www.mercedes-benz-mobile.com](http://www.mercedes-benz-mobile.com) for details or contact your local Mercedes-Benz Agent for further information

# Technical data Coupé

- Standard

Model		CLE 200	CLE 300 4MATIC	CLE 450 4MATIC	CLE 220 d
<b>Engine</b>					
Fuel delivery		Petrol	Petrol	Petrol	Diesel
Total displacement	cc	1,999	1,999	2,999	1,993
Arrangement/cylinders/valves		in-line/4/16	in-line/4/16	in-line/6/24	in-line/4/16
Power <sup>1</sup>	hp (kW) at rpm	204 (150)/5,800	258 (190)/5,800	381 (280)/5,800-6,100	197 (145)/3,600
Torque <sup>1</sup>	Nm at rpm	320/1,600-4,000	400/2,000-3,200	500/1,800-5,000	440/1,800-2,800
Compression ratio		12:01	10:01	10.5:1.0	15.5:1.0
Emissions standard		Euro 6d-ISC-FCM	Euro 6d-ISC-FCM	Euro 6d-ISC-FCM	Euro 6d-ISC-FCM

<b>Transmission</b>					
9G-TRONIC PLUS 9-speed automatic		●	●	●	●

<b>Performance</b>					
Acceleration 0-62 mph	sec	7.4	6.2	4.4	7.5
Top speed (electric mode)	mph	149	155	155	148

<b>Weights and capacities</b>					
Kerb weight <sup>2</sup>	kg	1,790	1,855	1,945	1,870
Perm. Gross Vehicle Weight	kg	2,265	2,330	2,400	2,345
Boot capacity - seats up	l	420	420	420	420
Towing capacity - unbraked/braked	kg	750/1,800	750/1,800	750/1,800	750/1,800
Fuel tank capacity/of which reserve	l	66/7	66/7	66/7	66/7
Turning circle	m	11.2	11.7	11.7	11.2

<sup>1</sup>Figures according to Directive 80/1269/EEC in the currently applicable version    <sup>2</sup>Mass of the vehicle in running order with at least 90% full fuel tank, plus the mass of the driver (estimated by law at 75kg), fuel and fluids, equipped with the standard equipment as specified by the manufacturer as well as, where applicable, the mass of the body, cab, trailer coupling and spare wheel(s) as well as tools. Optional extras, additional equipment and accessories can influence the weight, residual payload, rolling resistance, aerodynamics, etc., and therefore also affect the consumption/CO<sub>2</sub> values

# Technical data Coupé

Model		CLE 200	CLE 300 4MATIC	CLE 450 4MATIC	CLE 220 d
<b>Fuel consumption<sup>3,4,5</sup></b>					
Combined (consumption dependent on chosen optional equipment)	l/100 km	6.6-6.4	7.2-7.1	7.8-7.7	4.8-4.7
	mpg	42.8-44.1	39.2-39.8	36.2-36.7	58.9-60.1
<b>Insurance</b>					
Group rating		35E-37E	40E	43E	36E-38E

Insurance ratings may vary depending on model line and specification. Please refer to <http://www.thatcham.org/abigrouprating/> for further details

<sup>3</sup>All figures are based on a standard specification with the smallest tyre size available in the UK

<sup>4</sup>The choice of wheels and transmission may affect CO<sub>2</sub> emissions and corresponding Road Fund Licence

<sup>5</sup>The indicated values were determined according to the prescribed measurement method - Worldwide Harmonised Light Vehicle Test Procedure (WLTP). Figures shown may include options which are not available in the UK



# AMG Line

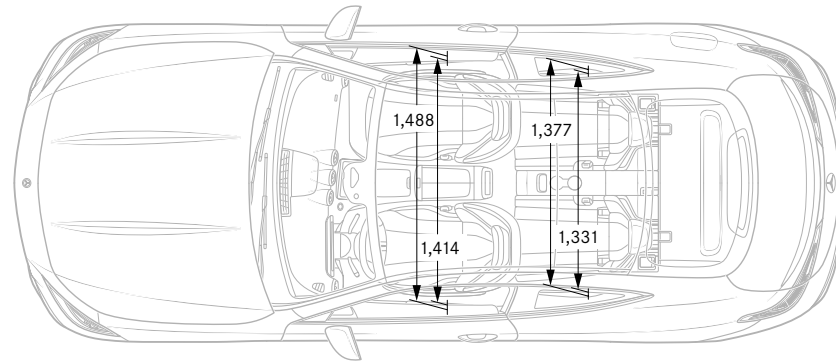
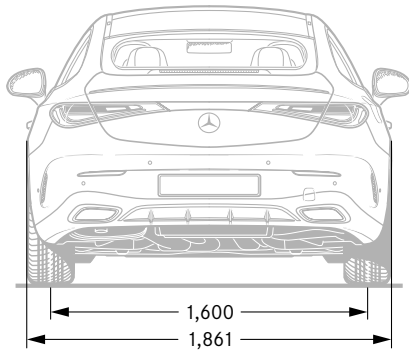
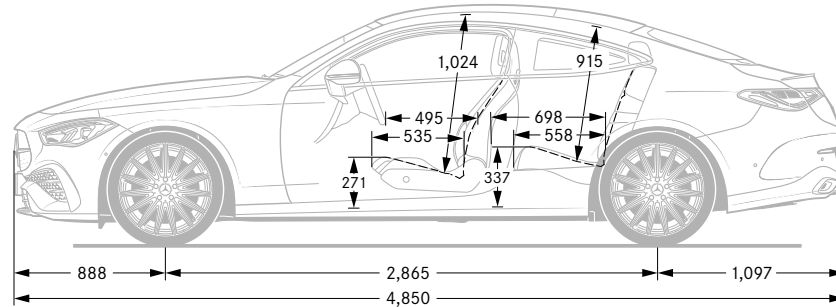
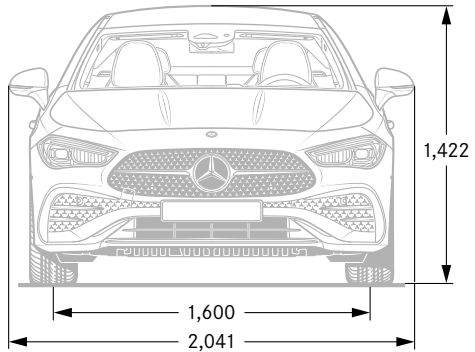

All measurements in millimetres. The dimensions shown are mean values and apply to standard-specification, unladen vehicles

Design	Technology	Model lines	Upholstery	Model prices	Personalisation	Standard equipment	Technical data	Additional information
--------	------------	-------------	------------	--------------	-----------------	--------------------	----------------	------------------------

# Road Fund Licence

All road vehicle registrations are subject to Vehicle Excise Duty (Road Fund Licence), which varies in accordance with the vehicle's CO<sub>2</sub> emissions. A first year rate for each taxation band will apply. The table below shows the bands (A-M) created by the DVLA and the corresponding Road Fund Licence. CO<sub>2</sub> emissions and the relevant Excise Duty are shown on the model pricing pages.

Band	CO <sub>2</sub> emissions (g/km)	First year rate petrol and RDE2 diesel (£)	First year rate alternative fuel (£)	Electric vehicles		Alternative fuel vehicles		Petrol/diesel vehicles	
				Standard rate (£)	Premium rate (£) <sup>1</sup>	Standard rate (£)	Premium rate (£) <sup>1</sup>	Standard rate (£)	Premium rate (£) <sup>1</sup>
A	0	0.00	0.00	0.00	0.00	0.00	0.00	0.00	0.00
B	1 to 50	10.00	0.00	0.00	0.00	170.00	560.00	180.00	570.00
C	51 to 75	30.00	20.00	0.00	0.00	170.00	560.00	180.00	570.00
D	76 to 90	130.00	120.00	0.00	0.00	170.00	560.00	180.00	570.00
E	91 to 100	165.00	155.00	0.00	0.00	170.00	560.00	180.00	570.00
F	101 to 110	185.00	175.00	0.00	0.00	170.00	560.00	180.00	570.00
G	111 to 130	210.00	200.00	0.00	0.00	170.00	560.00	180.00	570.00
H	131 to 150	255.00	245.00	0.00	0.00	170.00	560.00	180.00	570.00
I	151 to 170	645.00	635.00	0.00	0.00	170.00	560.00	180.00	570.00
J	171 to 190	1,040.00	1,030.00	0.00	0.00	170.00	560.00	180.00	570.00
K	191 to 225	1,565.00	1,555.00	0.00	0.00	170.00	560.00	180.00	570.00
L	226 to 255	2,220.00	2,210.00	0.00	0.00	170.00	560.00	180.00	570.00
M	over 255	2,605.00	2,595.00	0.00	0.00	170.00	560.00	180.00	570.00



Some of the model features, optional extras and colours shown may not be available, or may only be available in a different specification, or at a different price  
<sup>1</sup>Premium rate only applicable to vehicles where the list price is over £40,000 including any factory-fitted options, standard UK delivery charge and VAT

# Services and insurance

## Mercedes-Benz ServiceCare

We believe that servicing costs should be as flexible and affordable as possible for your new CLE, which is why we offer ServiceCare, an easy way to budget for all your servicing costs. It spreads your bills into manageable payments based on whether you have a new or used Mercedes-Benz. With ServiceCare we guarantee the price of parts and labour for up to four services and safeguard against any further inflation. It also covers the cost of all recommended service items including brake fluid, spark plugs, air filters, fuel filters and screen wash. You can choose either to add your servicing costs into your monthly spend or pay the full amount in a one-off payment, giving you peace of mind that they are taken care of for the period of the plan.

[Click here for more information](#)

## Warranty and breakdown cover

Every Mercedes-Benz comes with a three-year unlimited mileage warranty against manufacturing or material defects<sup>1</sup> and up to 30 years warranty against perforation due to corrosion from the inside out.<sup>2</sup> What's more, it's also covered by Mercedes-Benz Roadside Assistance – a unique package comprising up to 30 years pan-European breakdown assistance.<sup>2</sup>

## Motor Insurance

Superb cover comes as standard. When reviewed by an independent research company, Defaqto, Mercedes-Benz Motor Insurance received a five-star rating, the highest rating available. We design our Motor Insurance specifically for Mercedes-Benz drivers.

[Get a quote](#)

<sup>1</sup>Applies to vehicles sold by Mercedes-Benz in the UK to its franchised Retailers

<sup>2</sup>Subject to full Terms and Conditions, dependent on date of registration, available upon request

Mercedes-Benz Motor Insurance is underwritten by Aviva Insurance UK Limited. Credit provided, subject to status, by Mercedes-Benz Financial Services UK Ltd, MK15 8BA



Effective from September 2023 Production. Information correct at time of publication 01.11.2023.  
Prices and specifications are subject to change without prior notice.  
MBC236PL/1123 MY804

